

flow-captor 412x.1x



Operating Instructions

Metering flow switch with analog display

Please read carefully! No liability can be accepted for damage caused by improper use of the flow-captor!

9. Cover

To protect the flow-captor against pollution and unauthorized adjustment, it is supplied with a plastic cover. Before use this cover should first be removed. This is carried out by turning the enclosed screwdriver through 90° as illustrated in the sketch. After finishing all adjustments remove the protective pull-off sheet which covers an adhesive layer on the flow-captor face plate and press the protective cover onto the flow-captor.

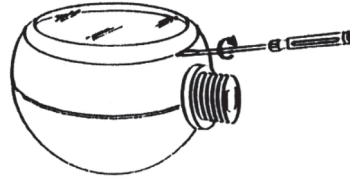

CAUTION:

To avoid loss of adhesion the inside surface of the cover should be kept free from dirt and oil!

flow-captor 4120.12/.13, 4121.12/.13

Metering flow switch with analog display

- Sensor head of stainless steel WN 1.4305 (V2A, 303)
- Housing, front plate, anodized aluminium
- Display of 9 LEDs; functions:
 - Analog display of flow from 0 to 100 %
 - Display of set-point by flashing LED, adjustable from 1. to 8. LED
- Potentiometer for 'Set-point'
- LED for output indication "Flow-OK"
- Potentiometer for "Range"
- Sensing surface
- Thread G 1/2 A (1 /2 BSP), alt. 1 /2" - 14 NPT
- Section for SW 27 spanner (wrench)
- Housing, PBTP, glass fibre, reinf. (Ultradur®)
- PG-9 nut (cord grip) for SW 19 spanner (wrench)
- 2 m oilflex cable 3 x 0.5 mm²

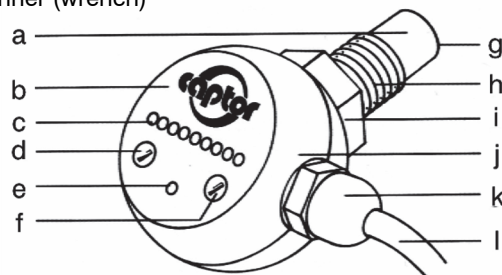

weber

Sensors GmbH · Strohdreich 32 · D-25377 Kollmar Tel.: +49 4128-591 Fax: -593 eMail: info@captor.de
Technical data subject to alteration! · Rev. AF / 18.02.20

flow-captor 412x.1x



Operating Instructions

Metering flow switch with analog display

Please read carefully! No liability can be accepted for damage caused by improper use of the flow-captor!

1. Mounting Position

To obtain highest accuracy of switching signal, the flow-captor should be mounted in a position of minimum turbulence. The position should be at least 5 x ID downstream and 3 x ID up stream of bends, valves, T-pieces or changes in pipe diameters.

Immersion depth min. 5 mm for small pipes up to 1 1/2" ID.

Preferred position is in a vertical pipe with upward flow. In a horizontal pipe, the flow-captor should be mounted at the side.

The sensor head orientation is independent from the flow direction.

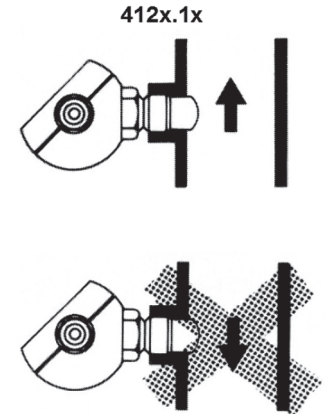

2. Mechanical Installation

The flow-captor should be installed into pipe at sufficient depth to ensure that the sensing surface is in contact with the flowing medium at all times. This is particularly important, if the flow-captor is mounted on top of the pipe or in a T-piece larger than the pipe work where cavitation (air bubbles) may occur.

The flow-captor can be installed in a T-piece. However it is much better to install it in a fitting welded to the pipework.

The thread should be sealed with Teflon tape or other commercial sealer, then the flow-captor tightened in the fitting using a size SW 27 spanner (wrench).

The final position should have the LED chain horizontal and reading left to right.

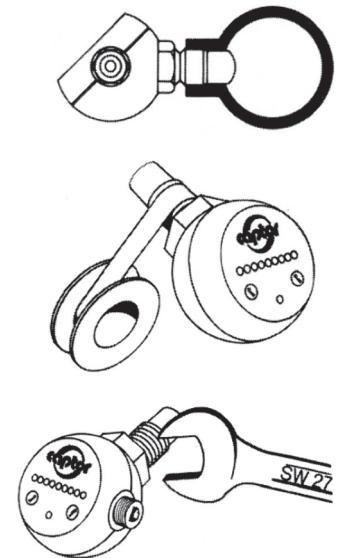

CAUTION: On no account the flow-captor housing should be used for tightening into the pipework!

weber

Sensors GmbH · Strohdreich 32 · D-25377 Kollmar Tel.: +49 4128-591 Fax: -593 eMail: info@captor.de
Technical data subject to alteration! · Rev. AF / 18.02.20

flow-captor 412x.1x



Operating Instructions

Metering flow switch with analog display

Please read carefully! No liability can be accepted for damage caused by improper use of the flow-captor!

3. Electrical Connection

Push the plug on the connecting cable into the opening of the flow-captor with light pressure; it is essential to observe the plug shape (see adjacent figure). Then tighten the PG-9 cable gland with a 19 mm spanner, holding it firmly to prevent the cable from turning.

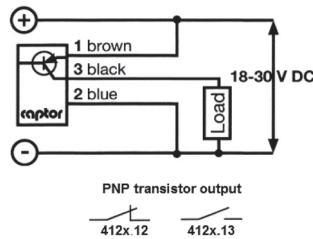
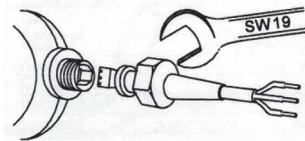

Connect wire end of the cable to power supply according to connection diagram, (brown to + voltage, blue to - voltage).

The voltage must be kept within the specified range at all times (18 to 30 VDC incl. residual ripple). Single rectification, i.e. half-wave voltage, is not allowed.

Load i.e. a relay between black (output) and blue (-). The first LED lights.

When power supply is switched on, the flow-captor will indicate flow for approx. 10 s (entire LED chain is lit, the green 'Flow OK' LED is on and one of the 9 LEDs is flashing - indicating adjusted set-point). After a time of 8 seconds the flow-captor is fully operational. At no flow only the first LED lights and one of the nine LEDs is flashing.

Scale of 4120.1x - (water)

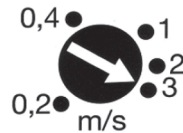

Scale of 4321.1x - (oil)

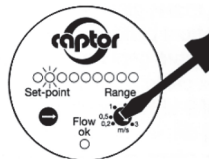
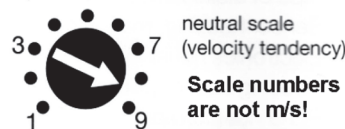

4. Medium

Scale of range potentiometer on 4120.1x is related to water. Depending on viscosity and thermal conductivity, other media require a multiplier (>1) i.e. 3 to 5 x for oil.

4121.1x is calibrated specifically for use with oil. The scale is equally divided between zero flow and max. flow range. Absolute values are not shown as these will vary with different types of oil.

5. Measurement of Flow Velocity (only 4120.1x)

Turn range potentiometer clockwise to maximum (3 m/s)

According to the flow rate a number of LEDs will be light up. In order to read the correct flow rate, turn the range potentiometer slowly, stepwise, counter-clockwise - this allows for re-adjustment of the range - until all LEDs are light up.

The actual flow speed is indicated by an arrow on the range pot.

flow-captor 412x.1x



Operating Instructions

Metering flow switch with analog display

Please read carefully! No liability can be accepted for damage caused by improper use of the flow-captor!

6. Range Adjustment

With the range potentiometer it is possible to define any measuring range between 0-20 cm/s up to 0-300 cm/s for water (approx. 0-30 cm/s up to 0-300 cm/s for oil, 4121.1x).

At the maximum flow rate, adjust the range potentiometer until all nine LEDs are just lit; each LED that is lit then represents approx. 10% of the maximum flow rate.

The resolution of the set-point depends on the range adjustment, e.g. with a range of 0-2 m/s the resolution is approx. 20 cm/s per LED step, with 0-30 cm/s the resolution is approx. 3 cm/s per LED step.

- LED flashing
- LED shining
- LED off

7. Set-point Adjustment

The set-point can be adjusted to anywhere within 15% of the absolute minimum range and 90% of the absolute maximum range.

The set-point value is indicated by a flash LED, and is shown relative to the adjusted range. When the velocity passes the flow set-point, the green "Flow OK" LED changes state (the green LED is lit when the velocity is above the set-point).

Resolution is shown in steps of approx. 10 % but with care, it is possible to achieve a much finer adjustment. If the flowrate is higher than 10 % of the calibrated range, the 9. LED will flash with the double frequency of the set-point LED.

8. Response time

The response time is shortened, the closer the set-point is to the normal flow rate.

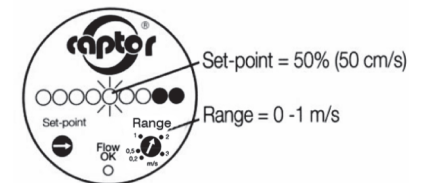
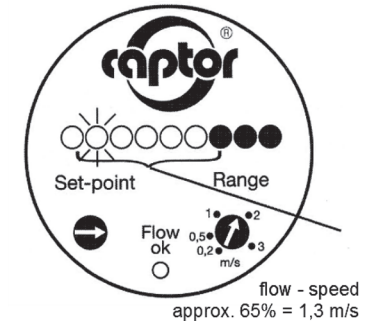

weber

weber