

STC 2MS Series Stainless Steel Solenoid Valves

Two-Way Pilot Piston for High Temp. & Pressure



2MS120-500 Series Specifications

Valve Model	2MS120	2MS150	2MS200	2MS250	2MS320	2MS400	2MS500	2MSO120	2MSO150	2MSO200	2MSO250	2MSO320	2MSO400	2MSO500
Port Size	3/8" NPT	1/2" NPT	3/4" NPT	1" NPT	1 1/4" NPT	1 1/2" NPT	2" NPT	3/8" NPT	1/2" NPT	3/4" NPT	1" NPT	1 1/4" NPT	1 1/2" NPT	2" NPT
Port Size (Flange)		1/2 F	3/4 F	1 F	1 1/4 F	1 1/2 F	2 F							
Orifice	12mm	15mm	20mm	25mm	32mm	40mm	50mm	12mm	15mm	20mm	25mm	32mm	40mm	50mm
Flow Coefficient (Cv)	4.5	4.5	7.6	12	22	30	48	4.5	4.5	7.6	12	22	30	48
Valve Type	2 Way, Normally Closed (NC)							2 Way, Normally Open (NO)						
Action	Pilot Piston													
Body Material	304 Stainless Steel													
Seal Material	PTFE (Teflon)													
Operating Temperature	Media: -4°F to 356°F (-20°C to 180°C) Ambient: -4°F to 130°F (-20°C to 55°C)													
Standard Operating Pressure	6 PSI to 230 PSI							6 PSI to 145 PSI						
Medium Pressure Option (M)	AC Coil: 6 PSI to 725 PSI DC Coil: 6 PSI to 580 PSI													
High Pressure Option (H)	87 PSI to 1450 PSI				87 PSI to 1160 PSI									
Electrical Connections	D: DIN 43650, Form A (2W200C) M: 3ft Molded Cable Wires N: DIN with 1/2" NPT Circuit Conduit *ATEX: Explosion Proof Coil (2W200C-ATEX) *Only Available in High-Pressure (H) Option							D: DIN 43650, Form A (2W200C) M: 3ft Molded Cable Wires N: DIN with 1/2" NPT Circuit Conduit						
Coil Power	AC Coil: 22-28VA DC Coil: 12-30W													
Coil Duty	100% ED (Continuous Duty)													
Voltage Options	12VDC, 24VDC, 24VAC, 110/120VAC (50/60Hz), 220/240VAC (50/60Hz)													
Voltage Tolerance	±10% of Specified Voltage													
Ingress Protection	IP65													
Insulation Class	H Class													
Installation	No Orientation Requirement													
Service	Liquid, Air, Inert Gas, Steam, Vacuum													

2MS130-500 Series Components

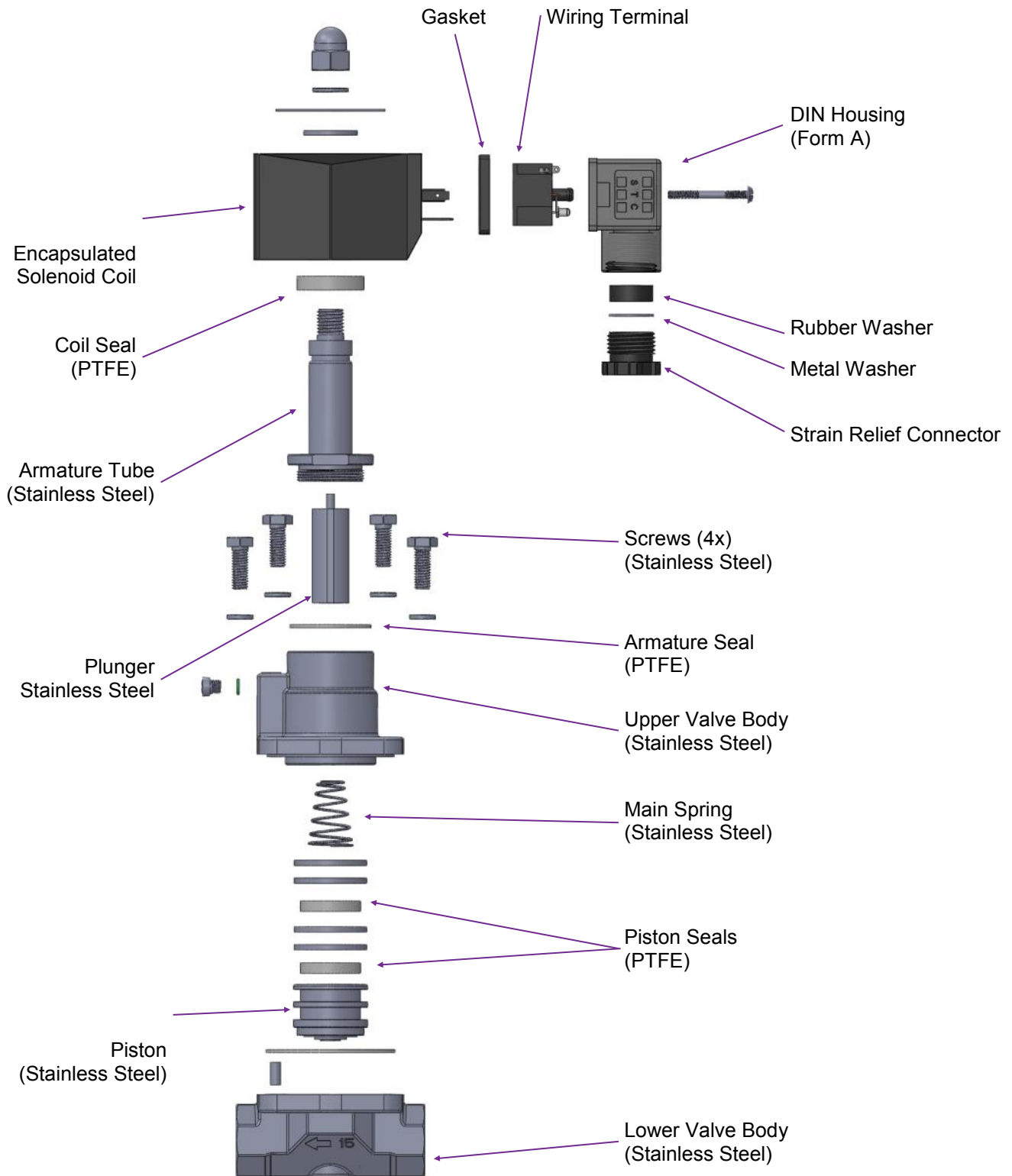

Note: Valve shown above is the Normally Closed (NC) version. Internal components for the Normally Open (NO) valve are similar, but have slight variations. This diagram is for illustrative purposes only.

Material Test Reports

This document certifies that STC products have been subjected to quality assurance procedures and meet the material and performance specifications published by Sizto Tech Corporation (STC). The products have been manufactured, processed, inspected, and tested according to STC internal requirements and ISO 9001 standards.

ISO 9001:2015 Certificate Number: **Qnb17180318**
 Date of Issue: **01, March, 2018**
 Valid Until: **28, February, 2021**

Individual materials and components used in this product have been tested and conform to applicable published standards according to chart below. Please be advised that STC does not conduct its own material analysis of all raw materials, rather, STC relies on the statements of its material suppliers & reserves the rights to independently test raw materials if necessary. Material Test Reports may be available for specific products upon request.

Material	Use Location	Material Standard
316 Stainless Steel	Metal Fittings, Valves, Air Cylinders	ASTM A240/A2666
304 Stainless Steel	Valves, Air Cylinders	ASTM A240/A666
CF8M Stainless Steel	Valves	ASTM A351/A743
Brass	Valves	ASTM B36/B62
Nickel-Plated Brass	Composite Fittings	ASTM B456/B927
Acetal Homopolymer (Delrin)	Valves	ASTM D4181/D6778—14
Acetal Copolymer (POM)	Composite Fittings	ASTM D4181/D6778—14
FKM (Viton)	Seals	ASTM D1418
PTFE (Teflon)	Valves, Seals	ASTM D3294—15
NBR (Buna N)	Seals	ASTM D1387—06
EPDM	Seals	ASTM D3568—03
Polybutylene Terephthalate (PBT)	Composite Fittings	ASTM D4000

Installation & Operation

To Connect the Valve Inlet & Outlet:

- Connect the inlet & outlet to the valve ports according to the flow direction arrow marked on the valve

To Install the Coil:

- Put the coils on to the armature tube of the valve. Place the lock washer & nut on to the armature tube. Hand tighten the nut, then use a wrench to tighten the nut another quarter-turn. Do not over-tighten the nut, as it may cause the armature tube to fail prematurely.

To Connect a DIN Coil:

1. Remove the Philips-head screw from the plastic DIN housing & unplug it from the DIN coil
2. From the screw opening, push the terminal block out from the plastic DIN housing.
3. Note the “1”, “2”, and ground “⊥” symbols on the underside of the DIN enclosure.
4. For DC DIN Coils, connect “1” to your Positive Lead & “2” to your Negative lead.
5. For AC DIN Coils, connect “1” to your HOT lead, “2” to your Neutral lead, & “⊥” to your ground if required.

Do not energize the coil without installing it onto the valve or connect the coil to a different voltage than specified. This will burn the coil and could create fire hazards.

Safety Note: Standard valves are supplied with continuous duty coils. The proper class of insulation for the service is indicated on the coil body. The coil temperature may rise significantly if energized for extended periods—this is normal. Although the coil is made of flame-retardant material, misuse of the coil could create fire hazards & generate smoke and/or a burning odor. If these conditions are encountered, the coil temperature has risen above safe levels and the power should be disconnected immediately.

Operation: This valve is a two-way, normally closed, pilot piston valve. As shown in the diagrams below, when the coil is de-energized (left diagram), the pilot plunger & piston sit on their respective orifices. The working medium flows through a tiny “bleed orifice” & pressurizes the cavity above the piston — this system pressure, along with the spring force, seals the valve. When the valve is energized the pilot plunger allows the working medium to flow through the pilot orifice. This releases the pressure above the piston & causes the incoming pressure to push it off of the main orifice, allowing the working medium to flow fully through the valve. Since the bleed orifice is dimensionally smaller than the main orifice, the system pressure cannot rebuild on the top of the diaphragm as long as the main orifice remains open. The working medium & flow direction are indicated in purple in the diagrams.

Note: The valve show below is a *Normally Closed (NC)* valve. The normally open version function in a similar matter, albeit in reverse.

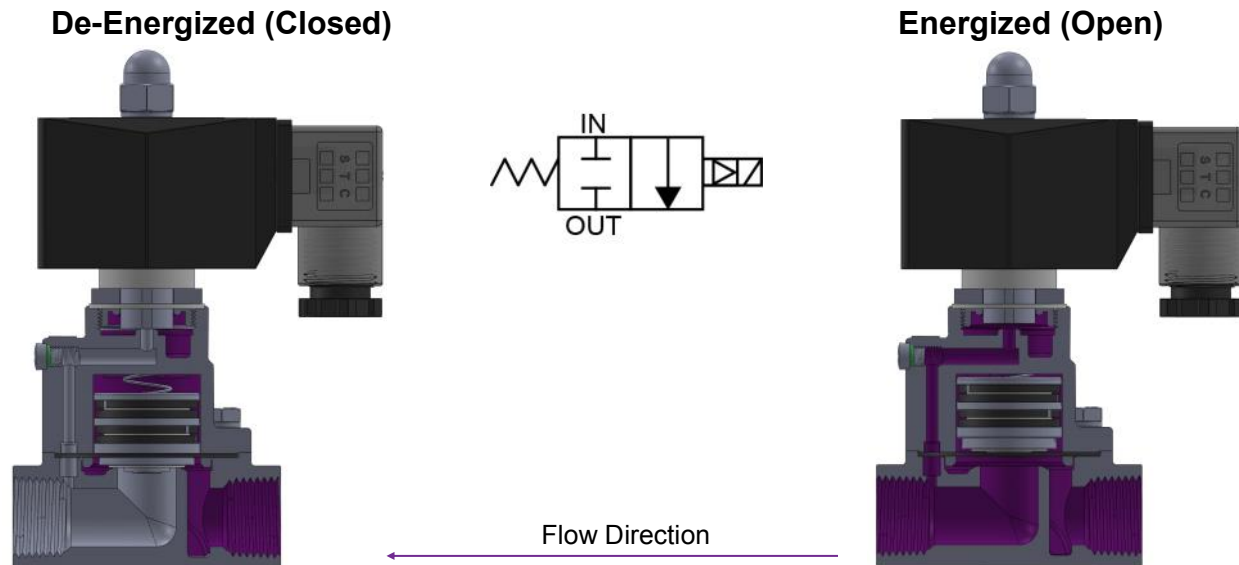

2MS120-500 Series Solenoid Valve Dimensions

Normally Closed (NC)

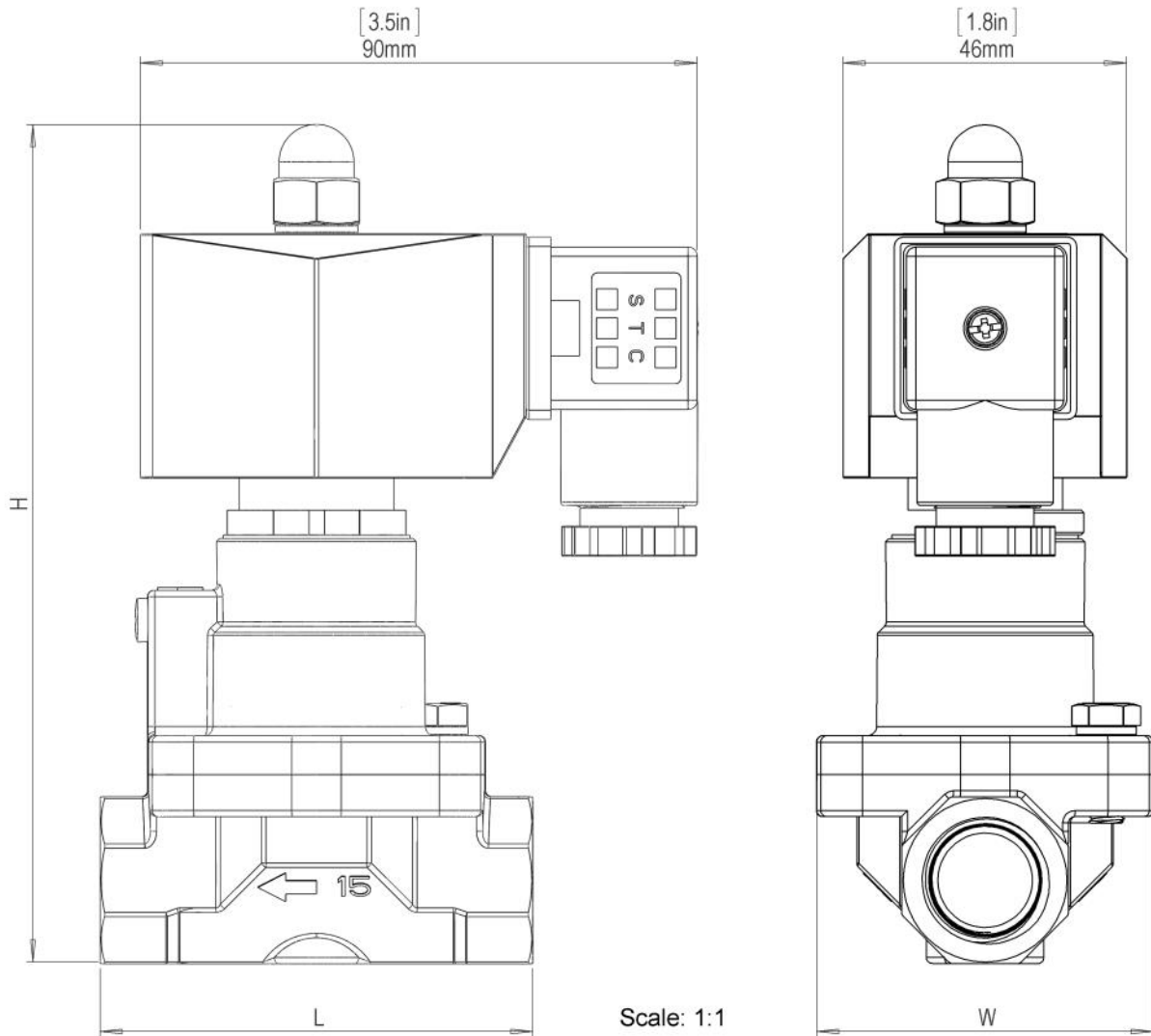

2MS120-500 Dimensions [mm]						
Valve Model	Port Size (NPT)	Orifice	Cv	H	L	W
2MS120	3/8"	12mm	4.5	128	72	55
2MS150	1/2"	15mm	4.5	137	81	55
2MS200	3/4"	20mm	7.6	137	75	59
2MS250	1"	25mm	12	148	93	70
2MS320	1 1/4"	32mm	22	173	115	87
2MS400	1 1/2"	40mm	30	173	124	95
2MS500	2"	50mm	48	189	167	110

Note: Dimensions are for reference only. Field verify dimensions prior to installation for critical dimensions.

2MSO120-500 Series Solenoid Valve Dimensions

Normally Open (NO)

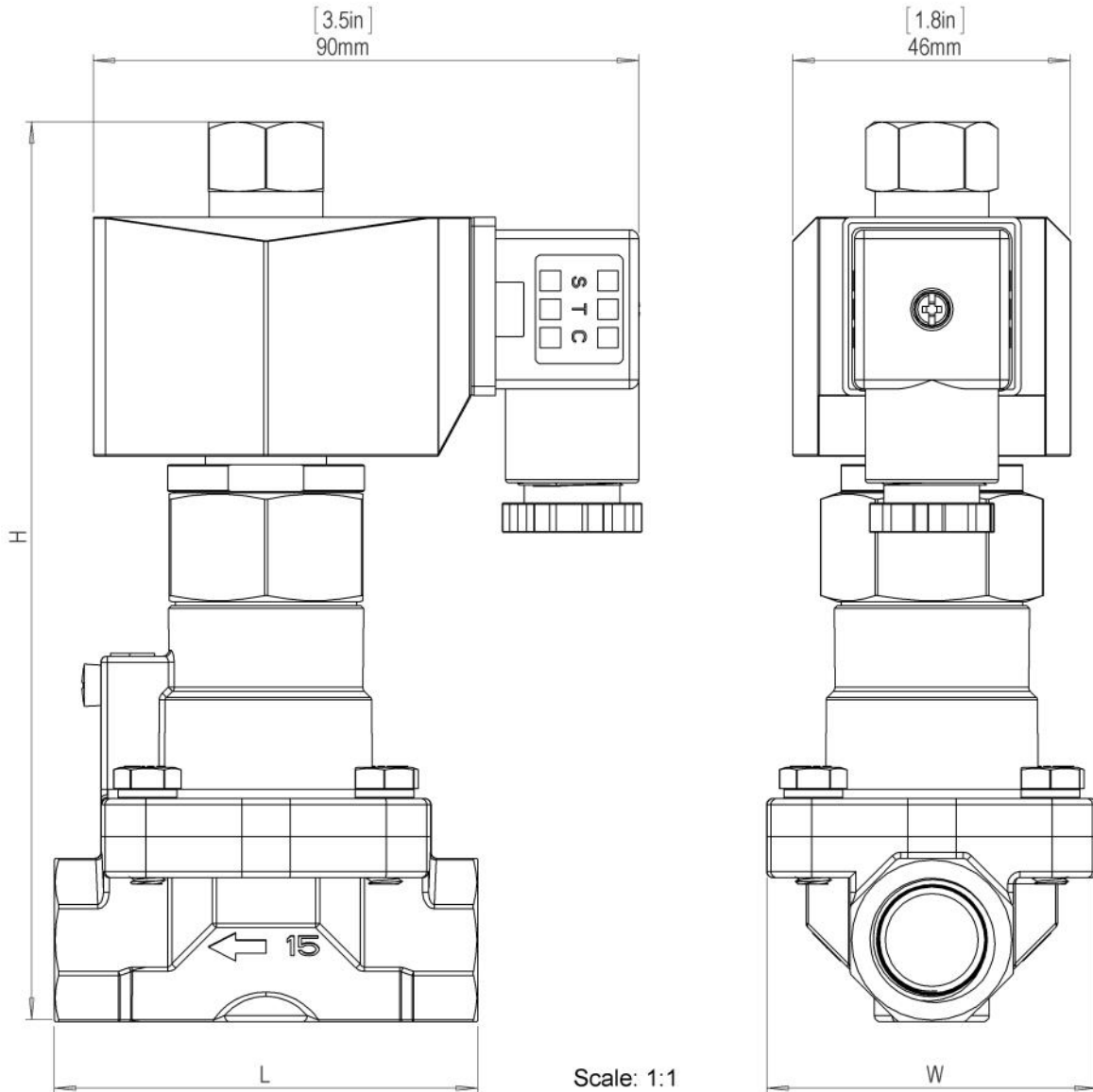

2MSO120-500 Dimensions [mm]						
Valve Model	Port Size (NPT)	Orifice	Cv	H	L	W
2MSO120	3/8"	12mm	4.5	148	71	55
2MSO150	1/2"	15mm	4.5	148	71	55
2MSO200	3/4"	20mm	7.6	155	75	59
2MSO250	1"	25mm	12	167	92	70
2MSO320	1 1/4"	32mm	22	192	115	87
2MSO400	1 1/2"	40mm	30	192	124	95
2MSO500	2"	50mm	48	208	167	110

Note: Dimensions are for reference only. Field verify dimensions prior to install for critical dimensions.



2MS120-500 Series Flow Rates

Water Flow Rate vs. Pressure

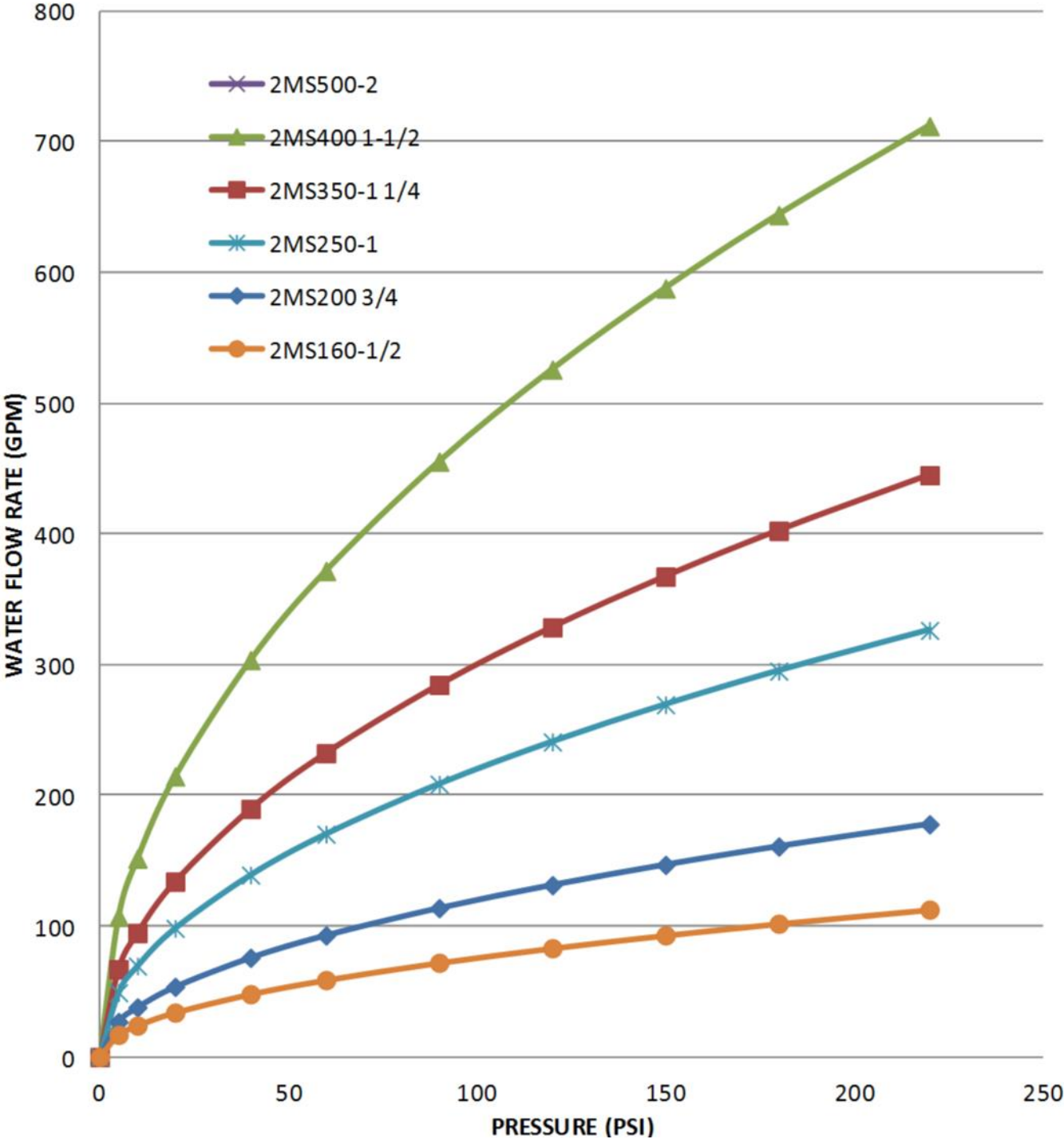

Note: Values show in the chart above are for reference only and may vary due to operating conditions, working medium, etc. Please verify data for critical installation prior to use.



2-Way Pilot Piston Valves

Maintenance & Troubleshooting Guide

Warning: DO NOT over tighten the nut holding the coil to the armature tube. Over tightening may result in damage to the welded joint.

Attaching a Coil to a Valve:

- After wiring the coil, fit the coil assembly over the armature tube. Ensure that the threads of the tube are accessible.
- Fit the spring or lock washer over the assembly.
 - For spring washers, the concave side should be oriented toward the coil.
- Tighten the nut over the washer by hand.
 - For standard washers, tighten the nut an additional $\frac{1}{4}$ turn with a wrench if necessary.
 - For spring washers, continue to tighten the nut until the spring washer is almost completely compressed.

Installation Procedure:

- Connect the default outlet to the outlet port indicated by an arrow or the number "1" on the valve body.
- Connect the default inlet to the pressure port indicated by the tail of the arrow or a "P" on the valve body.
- The arrow marked on the valve body indicates the direction of flow.

Notes:

- After an extended period of operation, the solenoid coil may burn out. This commonly occurs when input voltages are higher than the coil's specifications. If the valve does not make a clicking sound when energized/de-energized, the coil likely needs to be replaced.
- If you are using the valve at a low temperature, it may exhibit a small leak when first activated. This valve is supplied with PTFE seals, which are not elastic, but are formable. To fix the leak, cycle the valve at the highest available operating pressure & temperature until there is no longer a leak. This process will create a proper mating surface between the seal and the orifice.

Maintenance Procedure:

1. Turn off the power supply to the valve & ensure it is safely locked-out.
2. Remove any coils attached to the valve.
3. Unscrew the upper valve body to remove the armature assembly & valve body.
4. Check for any debris that may have collected on the plunger and/or diaphragm. A buildup of particulates on the diaphragm (especially near the two orifices) can cause the valve to function poorly. Clean the diaphragm with water & make sure to use a clean working medium with the valve.
5. Place the diaphragm back onto the lower body, followed by the upper body & armature assembly.
6. Screw the upper valve body back onto the lower valve body, ensuring that the diaphragm is aligned correctly.
7. Please refer to the diagram on Page 2 of this document for a breakdown of individual components.

For tips, maintenance guides, & procedural videos, visit us at www.youtube.com/users/STCValves

2-Way Pilot Piston Valves

Pilot Hole Cleaning Procedure

Warning: Ensure that all power is disconnected and the valve is free of pressure & working medium prior to disassembling the valve for maintenance or repair.

Cleaning the Pilot Hole:

- The 2MS Series valve is designed to be used with clean working media. If the valve does not open or close properly, the likely cause of the problem is a blocked or restricted pilot hole. Use the following cleaning procedure to removed debris & return the valve to proper operating conditions:
1. Remove the coil from the valve body
 2. Remove the (4) socket head machine screws from the valve
 3. Put a small wired through the hole in the valve cover as shown below. Dislodge & remove any small particles or debris that has built up inside the pilot hole
 4. Repeat Step #3 for the pilot hole in the piston as shown below.
 5. Reassemble the valve & test to assure it is functioning properly prior to returning it to service.

Note: If your working medium is not properly filtered and contains debris, the above procedure may be required on a regular basis to ensure the valve continue to function properly.

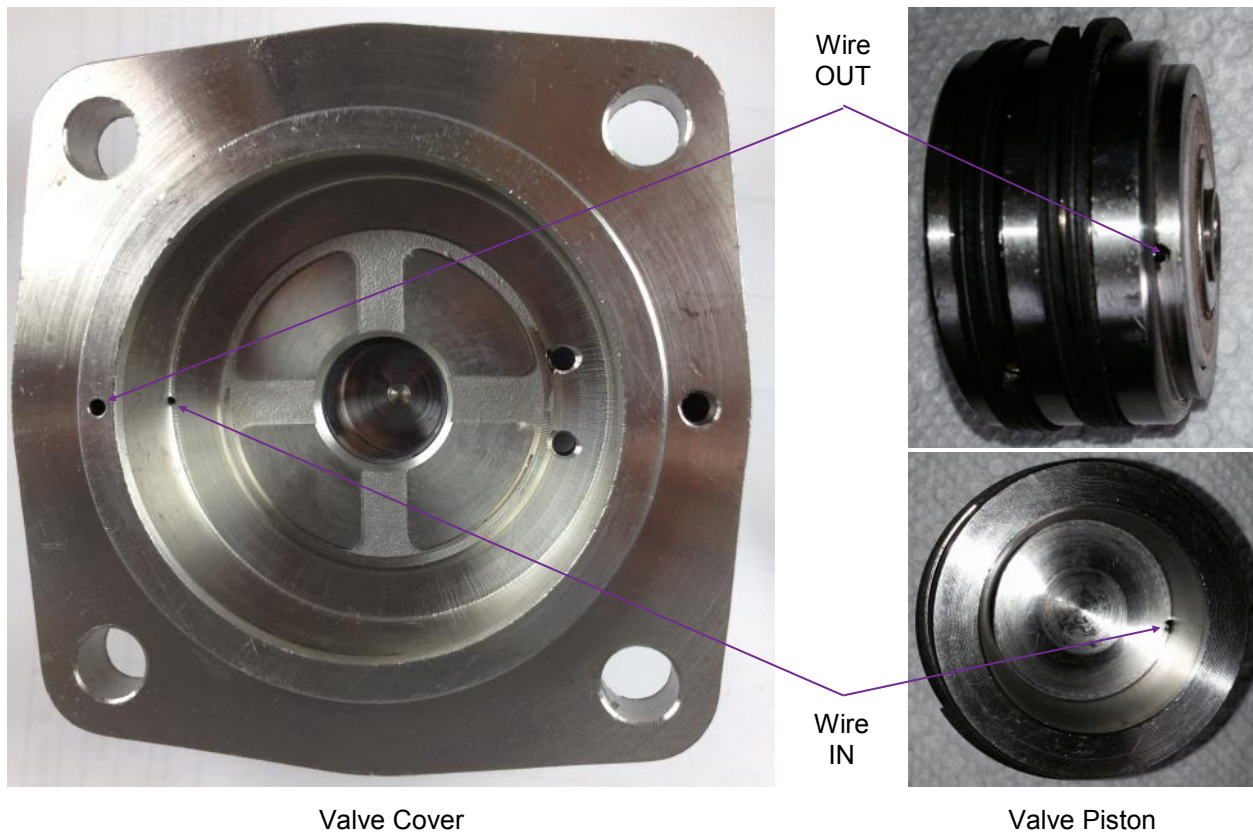

For tips, maintenance guides, & procedural videos, visit us at www.youtube.com/users/STCValves

2-Way Pilot Piston Valves

Pilot Hole Cleaning Procedure

Warning: Ensure that all power is disconnected and the valve is free of pressure & working medium prior to disassembling the valve for maintenance or repair.

Cleaning the Pilot Hole (Continued)

- During reassembly, make sure the large hole on the top half of the valve body aligns properly with the hole on the bottom half of the valve body, as shown in the picture below.

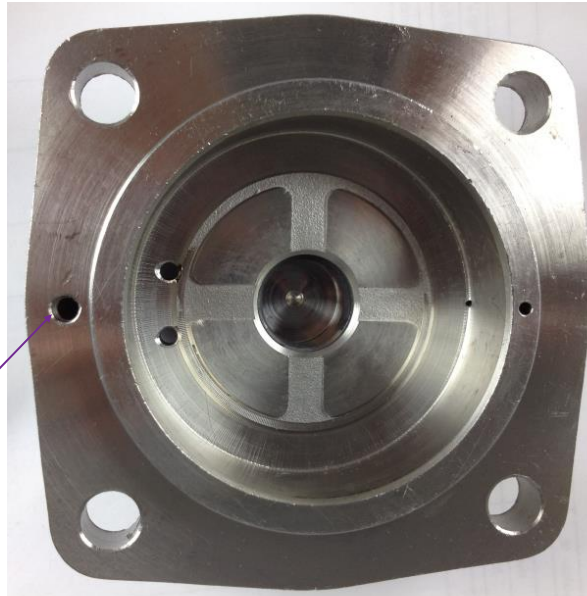

Top of Valve Body

Align

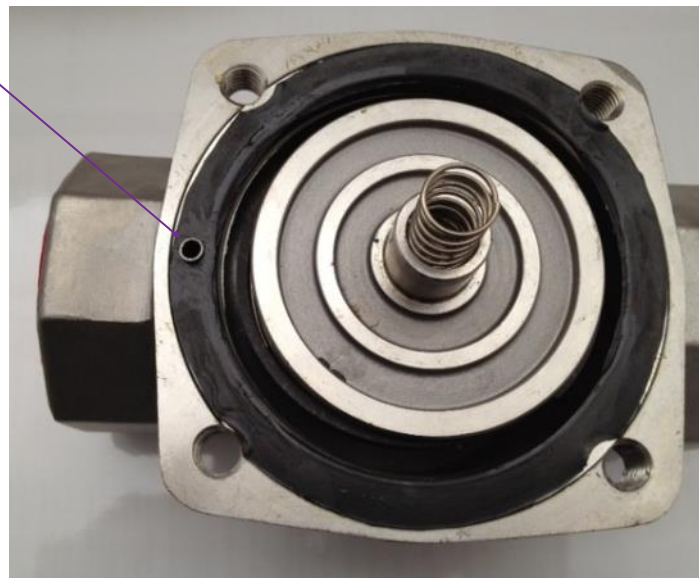

Bottom of Valve Body

For tips, maintenance guides, & procedural videos, visit us at www.youtube.com/users/STCValves

Electrical Connections

To Connect a DIN Coil:

- Remove the Philips screw from the plastic housing & unplug from the DIN coil.
- Use the removed screw to push the terminal block out of the plastic DIN housing.
- Note the “1”, “2”, and ground “⊥” symbols.
 - For DC DIN Coils, connect “1” to your positive lead & “2” to your negative lead.
 - For AC DIN Coils, connect “1” to your HOT lead, “2” to your NEUTRAL lead, and “⊥” to your ground lead, if required.

To Connect a Grommet Coil:

- For DC Coils, connect the red wire to your positive lead & the black wire to your negative lead.
- For AC Coils, connect the black wire to your HOT lead & the white wire to your NEUTRAL lead.
- For Coils provided with Molded Cables, the color of the wire indicates the type of lead:
 - GREEN = Ground Wire
 - BLUE = Positive or HOT Wire
 - BROWN = Negative or Neutral Wire

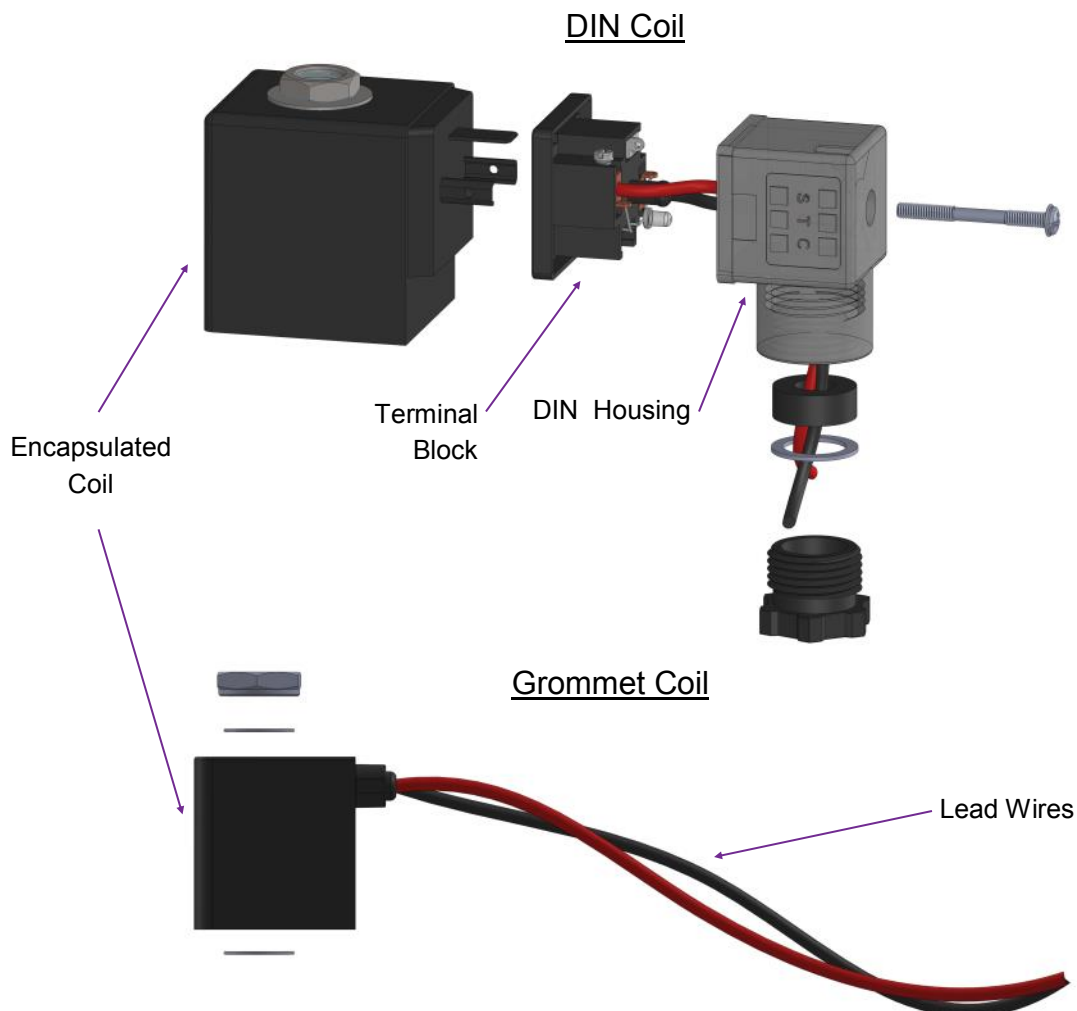

Terms & Conditions

By purchasing from SIZTO TECH CORPORATION (STC), you agree to these TERMS AND CONDITIONS. No other terms shall apply except as agreed in writing & signed by STC. We reserve the right to correct typographic errors and reject orders.

SHIPMENTS:

All shipments are F.O.B. 892 Commercial Street, Palo Alto, CA 94303, USA. Most orders are shipped via UPS Standard Ground unless instructions accompany order. Outside the UPS zones, shipment will be made Best Way. The responsibility for goods delay, lost or damaged in transit rests with the carrier and purchaser. Purchaser may purchase shipping insurance to cover lost or damaged products caused by shipping.

RETURN OF MERCHANDISE:

No merchandise is accepted for return 30 days after delivery date. No credit allowed on merchandise shipped as ordered and returned without obtaining an authorization number IN ADVANCE. A 20% restocking charge applies to all returns, and transportation charges must be fully prepaid. We will pay **ground** transportation charges on re-sent or returned merchandise due to STC's error.

Shortages & Mis-Shipments: Any shortages or mis-shipments must be reported within 15 days.

CANCELLATION POLICY:

Blanket orders can be canceled 90 days before scheduled ship date. There will be a 10% charge if a blanket order is canceled within 90 days of scheduled ship date, and a 20% charge if canceled within 60 days. Regular orders for non-custom parts can be canceled any time before the order is shipped. For custom parts, a 30% down payment is required either at the time of order or 90 days prior to scheduled ship date, whichever comes later.

Remittances should be sent to:

Sizto Tech Corporation, 892 Commercial Street, Palo Alto, CA 94303, USA
Credit Card Payments: Visa, MasterCard, Discover, or American Express accepted

International Customers: Advance Payment Required via Bank Wire, Cashier's Check or Approved Credit Card.

Credit Application: To establish a net 30 day account, please mail or fax three trade references with complete mailing addresses and account numbers, or request an STC Credit Application.

LIMITED WARRANTY – IMPORTANT NOTICE TO PURCHASER:

Sizto Tech Corporation (STC) only warrants this product to be free from defects in materials and workmanship at the time of shipment. This limited warranty expires one year after delivery to the end-user. STC's entire obligation to the Purchaser for breach of this limited warranty shall be limited to replacement of the defective product or refund of the original purchase price of this product, at STC's option. Purchaser has thirty (30) days to return the goods after STC has agreed to accept the return. All freight charges on returned material shall be paid by the Purchaser. STC's limited warranty shall not apply, however, to the product that have been subjected to misuse, alteration, accident or negligence during handling or storage.

DISCLAIMER OF IMPLIED WARRANTIES:

All implied warranties, which may arise by implication of law or application of course of dealing or usage of trade, including, but not limited to, implied warranties of merchantability or fitness for a particular purpose are expressly excluded. There are no warranties, which extend beyond the description of the faced hereof. The end user is solely responsible for the suitability and fitness of this product selected for a particular application.

OBLIGATIONS

You warrant, represent and agree: (1) to comply with all laws; (2) that our sale and shipment of the product will not, by export thereof, your legal status or otherwise, cause us to violate any law; and (3) to indemnify us against any losses from a failure by you or a third party to comply with law or these terms and conditions, or from use of the product.

SAFETY

WARNING: Improper Selection or Failure to follow Usage Instructions of the products described on the Sizto Tech Corporation (STC) Internet Site and its related publications can cause Death, Personal Injury, and Property Damage. All system set-ups require the supervision of a qualified individual who is familiar with installation, inspection and testing through training or experience.

IMPORTANT NOTICE:

All prices are subject to change without notice. We continuously improve the products, and we reserve the right to change specifications without incurring any obligation to incorporate new factors in equipment previously sold.

Information contained herein may be changed without prior notification.

Sizto Tech Corporation

892 Commercial Street
Palo Alto, CA 94043 USA
Tel: 650-856-8833 | Fax: 650-856-8811
Email: Sales@StcValve.com | www.StcValve.com



www.StcValve.com