

PRODUCT ID: 31885

Switch

MODEL

SG3 SPDT/277VAC

DIMENSIONS

4.5" H x 2.75" W x 1" D (est. 1.2 lbs)

CONSTRUCTION

Finish: Switch plate brushed stainless steel

Switch: Switch with indicator lights

Switch plate: Stamped stainless steel pre-punched for switch(es) and indicator light(s)

ELECTRICAL

Input Voltage: 277VAC

Product View

NOTE: Sign image may not exactly represent the finished product. For illustration purposes only.

Front View

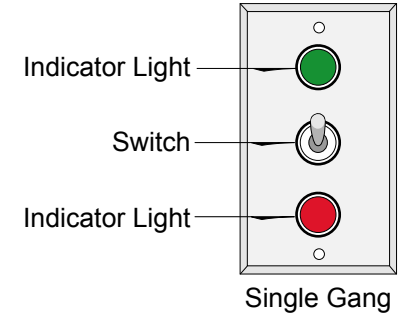

Schematic View

