



**ODP Series Dual Output  
Linear Programmable DC Power Supply  
User Manual**

■ ODP3122

■ ODP6062

[www.owon.com.cn](http://www.owon.com.cn)



7007020100052

**Nov. 2017 edition V1.0.1**

Copyright © LILLIPUT Company. All rights reserved.

The LILLIPUT's products are under the protection of the patent rights, including ones which have already obtained the patent rights and those which are applied for. The information in this manual will replace all materials published.

The information in this manual was correct at the time of printing. However, LILLIPUT will continue to improve products and reserves the rights to change specification at any time without notice.

**owon**<sup>®</sup> is the registered trademark of the LILLIPUT Company.

**Fujian LILLIPUT Optoelectronics Technology Co., Ltd.**

No. 19, Heming Road

Lantian Industrial Zone, Zhangzhou 363005 P.R. China

**Tel:** +86-596-2130430

**Fax:** +86-596-2109272

**Web:** [www.owon.com.cn](http://www.owon.com.cn)

**E-mail:** [info@owon.com.cn](mailto:info@owon.com.cn)

# General Warranty

OWON warrants that the product will be free from defects in materials and workmanship for a period of 2 years (1 year for accessories) from the date of purchase of the product by the original purchaser from the OWON Company. This warranty only applies to the original purchaser and is not transferable to a third party.

If the product proves defective during the warranty period, OWON will either repair the defective product without charge for parts and labour, or will provide a replacement in exchange for the defective product. Parts, modules and replacement products used by OWON for warranty work may be new or reconditioned like new. All replaced parts, modules and products become the property of OWON.

To obtain service under this warranty, the customer must notify OWON of the defect before the expiration of the warranty period. Customer shall be responsible for packaging and shipping the defective product to OWON's designated service centre, a copy of the customer's proof of purchase is also required.

This warranty shall not apply to any defect, failure or damage caused by improper use or improper or inadequate maintenance and care. OWON shall not be obligated to furnish service under this warranty a) to repair damage resulting from attempts by personnel other than OWON representatives to install, repair or service the product; b) to repair damage resulting from improper use or connection to incompatible equipment; c) to repair any damage or malfunction caused by the use of non-OWON supplies; or d) to service a product that has been modified or integrated with other products when the effect of such modification or integration increases the time or difficulty of servicing the product.

Please contact the nearest OWON's Sales and Service Offices for services or a complete copy of the warranty statement.

For better after-sales service, please visit [www.owon.com.cn](http://www.owon.com.cn) and register the purchased product online.

**Excepting the after-sales services provided in this summary or the applicable warranty statements, OWON will not offer any guarantee for maintenance definitely declared or hinted, including but not limited to the implied guarantee for marketability and special-purpose acceptability. OWON should not take any responsibilities for any indirect, special or consequent damages.**

# Table of Contents

<b>1. General Safety Requirements</b>	<b>1</b>
<b>2. Safety Terms and Symbols</b>	<b>2</b>
<b>3. Quick Start</b>	<b>3</b>
<b>3.1 Front/Rear Panel and User Interface</b>	<b>3</b>
3.1.1 Front Panel	3
3.1.2 Rear Panel	5
3.1.3 User Interface	6
Status Icons	6
<b>3.2 General Inspection</b>	<b>6</b>
<b>3.3 Power-On Check</b>	<b>7</b>
<b>3.4 Output Inspection</b>	<b>7</b>
3.4.1 Voltage Output Inspection	7
3.4.2 Current Output Inspection	7
<b>4. Front Panel Operation</b>	<b>9</b>
<b>4.1 Turn On/Off the Channel Output</b>	<b>9</b>
<b>4.2 Set the Output Voltage/Current</b>	<b>9</b>
4.2.1 Set the Output Voltage	9
4.2.2 Set the Output Current	9
<b>4.3 Over Voltage/Current Protection</b>	<b>10</b>
4.3.1 Set O.V.P	10
4.3.2 Set O.C.P	10
<b>4.4 M1, M2, M3 Quick Output</b>	<b>11</b>
<b>4.5 Programmable Output</b>	<b>11</b>
4.5.1 Data View	11
4.5.2 Output Set	12
4.5.3 Data process	12
4.5.4 Turn On/Off Programmable Output	13
<b>4.6 Save Settings/Auto Record</b>	<b>13</b>
4.6.1 Save Settings	13
4.6.2 Auto Record	14
4.6.3 View Record	14
<b>4.7 Sense mode</b>	<b>15</b>
<b>4.8 Utility Settings</b>	<b>16</b>
4.8.1 Language	16
4.8.2 Brightness	17
4.8.3 Beeper	17

4.8.4 Clock .....	17
<b>4.9 System Info .....</b>	<b>17</b>
4.9.1 View System Information .....	17
4.9.2 Set as Default.....	17
4.9.3 Update .....	18
<b>4.10 Port Settings.....</b>	<b>19</b>
4.10.1 Serial port .....	19
4.10.2 LAN Set .....	19
4.10.3 LCD Test.....	20
4.10.4 Key Test .....	20
<b>5. Troubleshooting .....</b>	<b>21</b>
<b>6. Technical Specifications .....</b>	<b>22</b>
<b>7. Appendix.....</b>	<b>23</b>
7.1 Appendix A: Packaging .....	23
7.2 Appendix B: General Care and Cleaning.....	24

# 1. General Safety Requirements

Before use, please read the following safety precautions to avoid any possible bodily injury and to prevent this product or any other connected products from damage. To avoid any contingent danger, ensure this product is only used within the ranges specified.

Only a qualified person should perform internal maintenance.

## To avoid Fire or Personal Injury:

- **Use Proper Power Cord.** Use only the power cord supplied with the product and certified to use in your country.
- **Product Grounded.** This instrument is grounded through the power cord grounding conductor. To avoid electric shock, the grounding conductor must be grounded. The product must be grounded properly before any connection with its input or output terminals.
- **Check all Terminal Ratings.** To avoid fire or shock hazard, check all ratings and markings on this product. Refer to the user manual for more information about ratings before connecting to the instrument.
- **Do not operate without covers.** Do not operate the instrument with covers or panels removed.
- **Use the Proper Fuse.** Use only the specified type and rating fuse for this instrument.
- **Avoid exposed circuit.** Be careful when working on exposed circuitry to avoid risk of electric shock or other injury.
- **Do not operate if any damage.** If you suspect damage to the instrument, have it inspected by qualified service personnel before further use.
- **Use your instrument in a well-ventilated area.** Please keep well ventilated and inspect the intake and fan regularly.
- **Do not operate in damp conditions.** To avoid short circuiting to the interior of the device or electric shock, please do not operate in a humid environment.
- **Do not operate in an explosive atmosphere.** To avoid damages to the device or personal injuries, it is important to operate the device away from an explosive atmosphere.
- **Keep product surfaces clean and dry.** To avoid the influence of dust or moisture in air, please keep the surface of device clean and dry.

## 2. Safety Terms and Symbols

### Safety Terms

**Terms in this manual** (The following terms may appear in this manual):



**Warning:** Warning indicates conditions or practices that could result in injury or loss of life.



**Caution:** Caution indicates the conditions or practices that could result in damage to this product or other property.

**Terms on the product.** The following terms may appear on this product:

**Danger:** Indicates an immediate hazard or injury possibility.

**Warning:** Indicates a possible hazard or injury.

**Caution:** Indicates potential damage to the instrument or other property.

### Safety Symbols

**Symbols on the product.** The following symbols may appear on the product:



Hazardous Voltage



Refer to Manual



Protective Earth Terminal



Chassis Ground



Public Ground

## 3. Quick Start

### 3.1 Front/Rear Panel and User Interface

#### 3.1.1 Front Panel

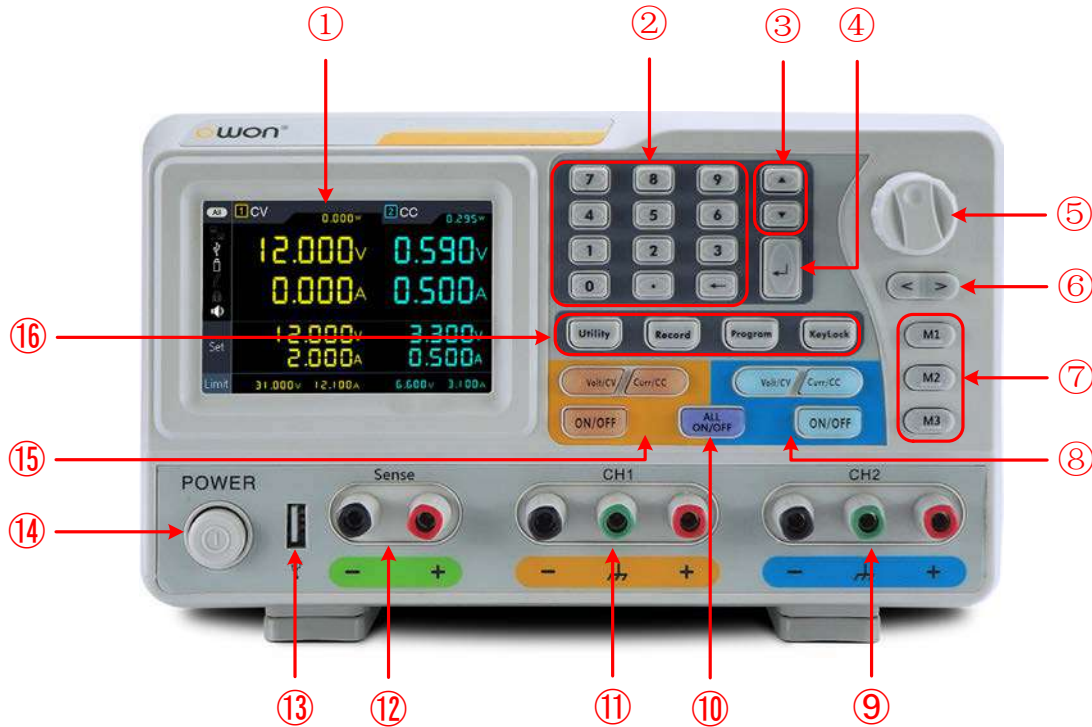

Figure 3-1 Front panel overview

① LCD	User interface display
② Numeric keys area	Parameter input, includes the numeric keys, decimal point and backspace key.
③ Up and down direction key	Select sub menu
④ Enter key	Enter menu or confirm the parameter entered
⑤ Knob	Select menu or change the value, pressing it has the same effect as pressing the enter key
⑥ Left and right direction key	Set sub menu or move the cursor
⑦ M1 key M2 key M3 key	Save three groups of output parameters of CH1 and CH2 respectively for quick outputting.

### 3.Quick Start

---

⑧	<b>CH2 control area</b>	<b>Blue</b> <b>Volt/CV</b> key: Set the output voltage of CH2 <b>Blue</b> <b>Curr/CC</b> key: Set the output current of CH2 <b>Blue</b> <b>ON/OFF</b> key: Enable/disable the output of CH2
⑨	<b>CH2 output terminals</b>	Channel 2 output connectors
⑩	<b>ALL key</b>	In the M1/M2/M3 setting interface, enable or disable the CH1 and CH2 output
⑪	<b>CH1 output terminals</b>	Channel 1 output connectors
⑫	<b>Sense terminals</b>	Compensate the voltage drop.
⑬	<b>USB Host port</b>	Connect as a "host device" with an external USB device, such as connect a USB disk to the instrument.
⑭	<b>Power button</b>	Turn on/off the instrument
⑮	<b>CH1 control area</b>	<b>Orange</b> <b>Volt/CV</b> key: Set the output voltage of CH1 <b>Orange</b> <b>Curr/CC</b> key: Set the output current of CH1 <b>Orange</b> <b>ON/OFF</b> key: Enable/disable the output of CH1
⑯	<b>Function keys</b>	<b>Utility</b> key: Menu of output mode, utility, info, port settings. <b>Record</b> key: Save settings, auto record, and view recording. <b>Program</b> key: Programmable output. <b>KeyLock</b> key: Press and hold this key for 5 seconds to lock the panel keys. Unlock method: Press and hold the key for more than 5 seconds, and release.

---

#### Instructions for panel key indicator

**ON/OFF** key: The indicator will be lit after you turn on the channel.

**Volt/CV** key: The indicator will be lit when the channel is in Constant Voltage output mode.

**Curr/CC** key: The indicator will be lit when the channel is in Constant Current output mode.

### 3.1.2 Rear Panel

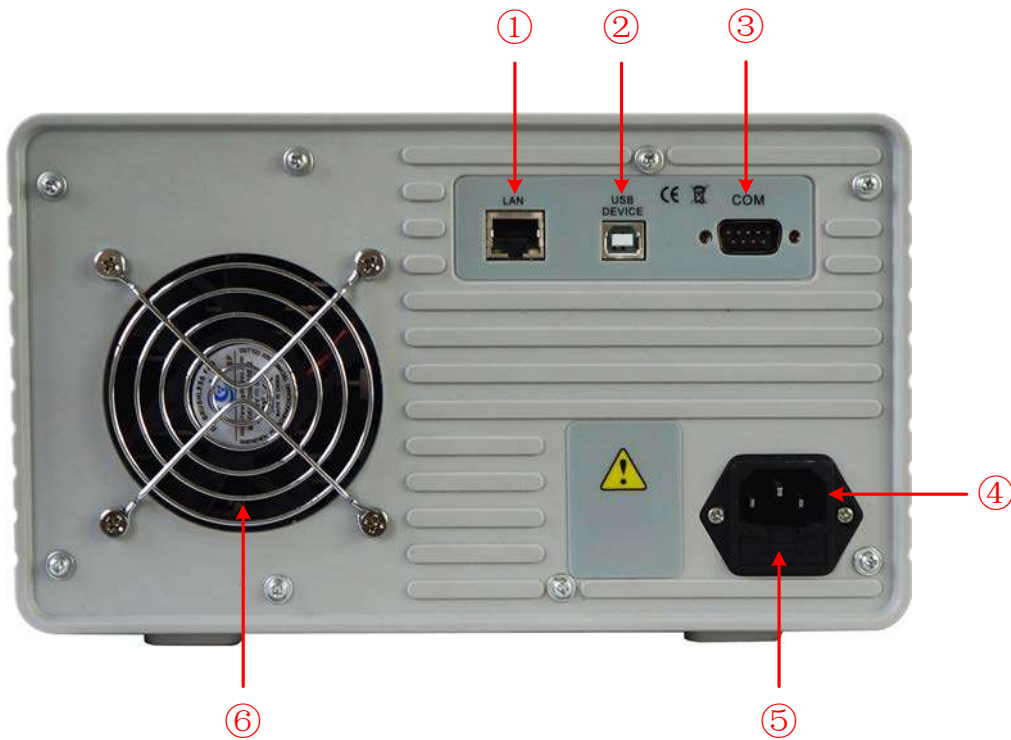

Figure 3-2 Rear panel overview

① <b>Local Area Network (LAN) Connector</b>	The power supply can be connected to the network for remote control via this connector.
② <b>USB Device Connector</b>	Connect as a "slave device" with an external USB device, such as connect the instrument to a PC.
③ <b>COM Connector</b>	Connect the power supply with external equipment as serial port.
④ <b>Power socket</b>	AC input connector
⑤ <b>Fuse</b>	Line fuse
⑥ <b>Fan</b>	Fan inlet

### 3.1.3 User Interface

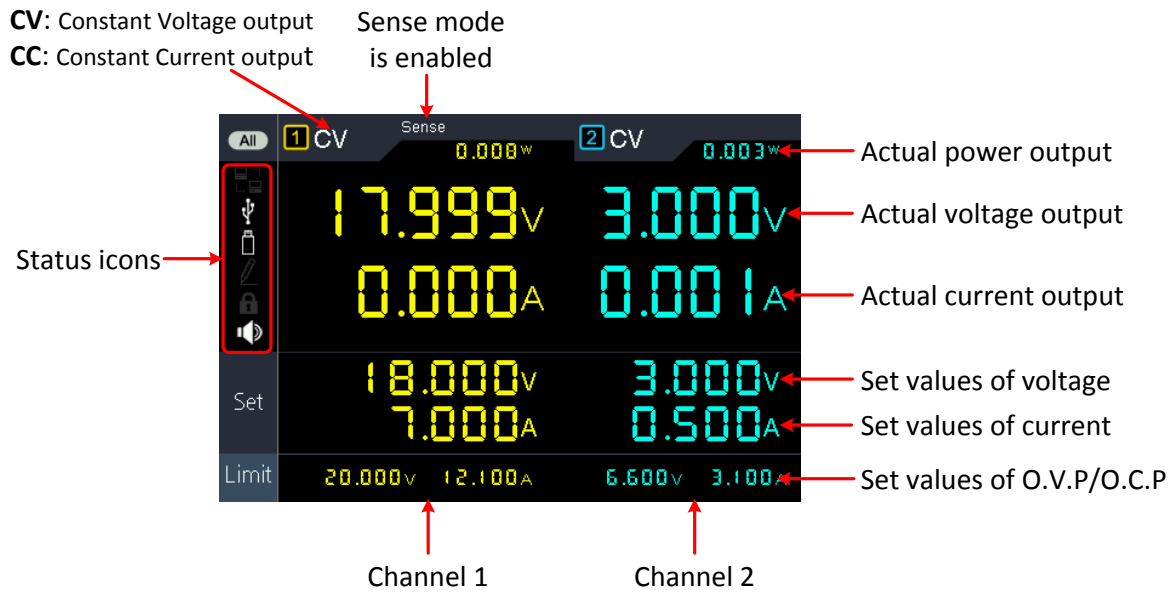







Figure 3-3 User interface

#### Status Icons

Icons	Instruction
	Connected to the network via LAN connector
	Connected as a slave device with PC
	A USB device is connected
	Recording the current output
	The panel keys are locked
	The beeper is turned on

### 3.2 General Inspection

When you receive your new power supply, it is recommended that you check the instrument following these steps:

#### 1. Check for transportation damage.

If it is found that the packaging carton or the foamed plastic protection cushion has suffered serious damage, do not throw it away until the complete device and its accessories have been electrically and mechanically checked.

### 2. Check the Accessories

The supplied accessories are described in the "Appendix A: " of this Manual. Please ensure that all the listed accessories are present and undamaged, if any problems are found please contact your distributor or OWON's local office.

### 3. Check the Complete Instrument

If there is any physical damage, operational fault, or performance issue please contact your distributor or OWON's local office. If there is any transportation damage to the instrument please ensure you keep the original packaging. Ideally you should always keep the original packaging if the instrument must be returned for repair.

## 3.3 Power-On Check

- (1) Connect the instrument to the AC supply using the supplied power cord.



#### **Warning:**

To avoid electric shock, the instrument must be grounded properly.

---

- (2) Push the **power button** on the front panel, the keys will light and the screen will show the boot screen.

## 3.4 Output Inspection

Output inspection is to ensure that the instrument can achieve its rated outputs and properly respond to operation from the front panel. For the procedures below, it is suggested that you read "*Turn On/Off the Channel Output*" on page 9 and "*Set the Output Voltage/Current*" on page 9.

### 3.4.1 Voltage Output Inspection

The following steps verify basic voltage functions without load:

- (1) When the instrument is under no load, select a channel and ensure the output current setting for this channel is not at zero.
- (2) Turn on the channel output, then ensure the channel is in Constant Voltage output mode.
- (3) Set some different voltage values on this channel; check if the actual voltage value displayed is close to the set voltage value, and also that the actual current value displayed is nearly to zero.
- (4) Check that if the output voltage can be adjusted from zero to the maximum rating.

### 3.4.2 Current Output Inspection

The following steps check basic current functions with a short across the power supply's output:

- (1) Connect a short across (+) and (-) output terminals with an insulated test lead on this

### 3.Quick Start

---

channel. Use a wire size sufficient to handle the maximum current.

- (2) Set the output voltage to the maximum rating on this channel.
- (3) Turn on the channel output. Ensure the channel you used is in Constant Current output mode.
- (4) Set some different current values on this channel; check if the actual current value displayed is close to the set current value, and to check if the actual voltage value displayed is nearly zero.
- (5) Check that if the output current can be adjusted from zero to the maximum rating.
- (6) Turn off the channel output and remove the short circuit from the output terminals.

## 4. Front Panel Operation

### 4.1 Turn On/Off the Channel Output

Press the **orange ON/OFF** key to turn on/off the Channel 1 output.

Press the **blue ON/OFF** key to turn on/off the Channel 2 output.

### 4.2 Set the Output Voltage/Current

#### 4.2.1 Set the Output Voltage

- **Set the output voltage of CH1**

Press the **orange Volt/CV** key, the first digit of the CH1 set voltage is flashing, indicating the value is editable. There are two methods to change the value.

**Modify:** Turn the **knob** to change the value. Press the **< / >** key to move the cursor. Press the **knob** or the **↵** key to confirm.

**Input:** Use the **numeric keys** to input, the input box of **Channel 1** output voltage will pop up. Enter a desired value. Press the **↵** key to confirm.

- **Set the output voltage of CH2**

Press the **blue Volt/CV** key to enter edit mode. You can set the value in the same way as CH1 above.

#### 4.2.2 Set the Output Current

- **Set the output current of CH1**

Press the **orange Curr/CC** key, the first digit of the CH1 set current is flashing, indicating the value is editable. There are two methods to change the value.

**Modify:** Turn the **knob** to change the value. Press the **< / >** key to move the cursor. Press the **knob** or the **↵** key to confirm.

**Input:** Use the **numeric keys** to input, the input box of **Channel 1** output current will pop up. Enter a desired value. Press the **↵** key to confirm.

---

**Note:** The minimum value for CH1 set current is 50 mA.

---

- **Set the output current of CH2**

Press the **blue Curr/CC** key to enter edit mode. You can set the value in the same way as CH1 above.

## 4.3 Over Voltage/Current Protection

When the Over Voltage Protection (O.V.P) or Over Current Protection (O.C.P) is enabled, once the output voltage/current reaches the set value of O.V.P/O.C.P, the instrument will cut off the output, a warning will show on the screen.

### Note:

When the instrument disables the output due to protection, after you make some adjustments, the channel must be restarted to output normally.

This function can keep the power output from exceeding the load rating to protect the load.

### 4.3.1 Set O.V.P

- **Set the O.V.P of CH1**

Press the **orange Volt/CV** key, the first digit of the CH1 set voltage is flashing. Press the **▼** key, the first digit of the CH1 O.V.P is flashing, indicating the value is editable. There are two methods to change the value.

**Modify:** Turn the **knob** to change the value. Press the **< / >** key to move the cursor. Press the **knob** or the **↵** key to confirm.

**Input:** Use the **numeric keys** to input, the input box of **Channel 1** limit voltage will pop up. Enter a desired value. Press the **↵** key to confirm.

- **Set the O.V.P of CH2**

Press the **blue Volt/CV** key, then press the **▼** key to enter edit mode. You can set the value in the same way as CH1 above.

### 4.3.2 Set O.C.P

- **Set the O.C.P of CH1**

Press the **orange Curr/CC** key, the first digit of the CH1 set current is flashing. Press the **▼** key, the first digit of the CH1 O.C.P is flashing, indicating the value is editable. There are two methods to change the value.

**Modify:** Turn the **knob** to change the value. Press the **< / >** key to move the cursor. Press the **knob** or the **↵** key to confirm.

**Input:** Use the **numeric keys** to input, the input box of **Channel 1** limit current will pop up. Enter a desired value. Press the **↵** key to confirm.





- **Set the O.C.P of CH2**

Press the **blue Curr/CC** key, then press the **▼** key to enter edit mode. You can set the value in the same way as CH1 above.

## 4.4 M1, M2, M3 Quick Output

You can save three groups of output parameters of CH1 and CH2 respectively for quick outputting. Press M1, M2 or M3 front panel key to enter into the setting interface.

Take M1 for instance:

- (1) Press the **M1** key.
- (2) In the setting interface, press the  /  key to move the cursor left and right. Press the  /  key to move the cursor up and down. Use the **numeric keys** to input, the input box will pop up. Enter a desired value. Press the  key to confirm.

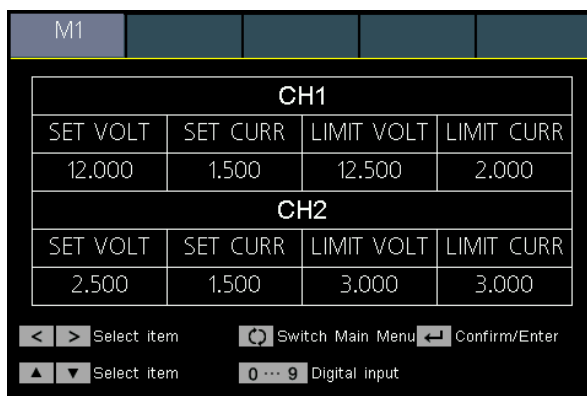

- (3) In the setting interface, press the **ALL** key to enable the CH1 and CH2 output with the setting parameters. Press the **ALL** key again to disable the output.







## 4.5 Programmable Output

The programmable output function is only available for CH1.



The programmable output function can preset up to 100 groups of timing parameters of CH1. When you turn on the programmable output, the instrument will output the pre-specified voltage, current in pre-specified time.

### 4.5.1 Data View



Press the **Program** key. The **Data view** menu is selected.



- (1) The **Memory** sub menu is selected. Press the  /  key to select **Internal** or **External**.
- (2) Press the  key to select **Import** submenu. Press the  key to import data.
- (3) Press the  key to select **Export** submenu. Press the  key to export data.



**Note:** When the memory is set as External, the programmable data file will be export to U disk, the directory is **ODPXXXX\Program** (ODPXXXX is the model)



(4) Press the  key to select **Clear Data** submenu. Press the  key to clear data.



### 4.5.2 Output Set

Press the  key, turn the  to select [**Output Set**].

(1) The **Cycle Mode** sub menu is selected. Press the  /  key to select **Oder** or **Loop**.



(2) Press the  key to select **Start Point** submenu. Use the **numeric keys** to input (1 to 100), press the  key to confirm.

(3) Press the  key to select **Stop Point** submenu. Use the **numeric keys** to input (1 to 100), press the  key to confirm.

(4) Press the  key to select **Start** submenu. Press the  key to enter the data processing interface and enable CH1 output.





### 4.5.3 Data process

You can set the programmable parameters of CH1, including voltage, current and output time. This function allows up to 100 parameter groups.

Press the  key, turn the  to select [**Data process**].

#### Edit:

(1) The **Edit** sub menu is selected. The operation instruction shows on the screen. Press the  key to enter the data processing interface.

(2) In the data processing interface, Press the  /  key to move the cursor left and right. Press the  /  key to move the cursor up and down. Use the After selecting the parameter, use the numeric keys to enter a desired value, press the  key to confirm.

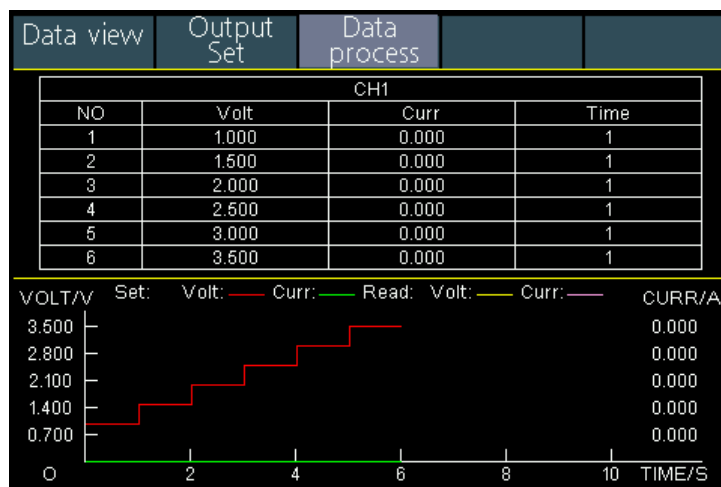









Figure 4-1 Data processing Interface

(3) Press  to back to sub menu selection.

**Graph process is used to configure the graphical display in the Data processing interface.**



- (1) Press the  key to select **Graph process** submenu. Press the  key to enter the editing interface.
- (2) In the Graph processing interface, Press the  /  key to move the cursor left and right. Press the  /  key to move the cursor up and down. Press the  key to check or uncheck the item. If the item is checked, the corresponding line will be displayed in the chart in the data processing interface.
- (3) Press  to back to sub menu selection.

#### 4.5.4 Turn On/Off Programmable Output

**In the data processing interface:**

Press **orange ON/OFF** key to turn on/off the programmable output.

**In the data processing interface:**

Press the  key to select **Start** submenu. Press the  key to enter the data processing interface and enable CH1 output.

---

**Note:**

In the process of programmable output, closing the channel output will reset the timer; turning on the channel again will restart the programmable output and the timer.















---

## 4.6 Save Settings/Auto Record

### 4.6.1 Save Settings

You can store, recall and delete current setting parameters. The storage memory could be set as internal or external (USB flash device). Up to 100 groups of settings can be saved.

Press the **Record** key. The **Save Settings** menu is selected.

- (1) The **Memory** sub menu is selected. Press the  /  key to select **Internal** or **External**.
- (2) Press the  key to select **Save** submenu. Press the  /  key to select the channel (CH1 or CH2), press the  key to save the setting of the selected channel. **Note:** When the memory is set as External, the setting will be saved to U disk as a CSV file, the directory is **ODPXXXX\Record\_Option** (ODPXXXX is the model).
- (3) Press the  key to select **Delete** submenu. Press the  key, a red box will show in the table, indicating the selected item. Press the  /  key to select. Press the  /  key to turn the page. Press the  key to delete. Press  to back to

sub menu selection.

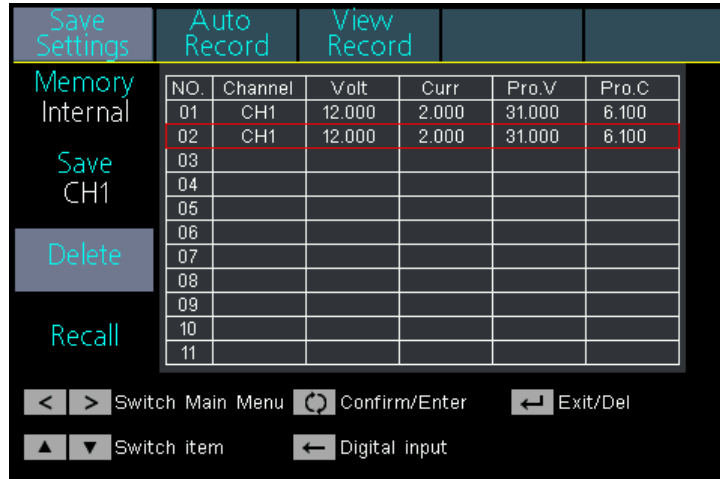

- (4) Press the key to select **Recall** submenu. Press the key, a red box will show in the table, indicating the selected item. Press the / key to select. Press the / key to turn the page. Press the key to recall. Press to back to sub menu selection.

#### 4.6.2 Auto Record

Press the **Record** key, turn the knob to select [**Auto Record**].

- (1) The **Memory** sub menu is selected. Press the / key to select **Internal** or **External**.
- (2) Press the key to select **Interval** submenu. Use the **numeric keys** to set the record interval, press the key to confirm.
- (3) Press the key to select **Points** submenu. Use the **numeric keys** to set the points, press the key to confirm.
- (4) Press the key to select **Record Status** submenu. Press the / key to select the channel (CH1 or CH2), press the key to start recording the output of the selected channel. Press the key again to stop recording. During recording, the icon will be lighted on the status bar.

**Note:** When the memory is set as External, the record file will be saved to U disk as a CSV file, the directory is **ODPXXXX\Record\_Auto** (ODPXXXX is the model).

#### 4.6.3 View Record

Press the **Record** key, turn the knob to select [**View Record**].

- (1) Press the key to select **Memory** submenu. Press the / key to select **Internal** or **External**.
- (2) When the Memory is set as **Internal**, press the key to select **Read** submenu. Press

## 4. Front Panel Operation

the  $\leftarrow$  /  $\rightarrow$  key to select the channel (CH1 or CH2), press the  $\leftarrow$  key to read the recording file of the selected channel. After reading successfully, if the display mode is set as Table, a red box will show in the table, indicating you can press the  $\leftarrow$  /  $\rightarrow$  key to turn the page. Press  $\leftarrow$  to back to sub menu selection.

When the Memory is set as **External**, press the  $\uparrow$  key to select **Export** submenu. Press the  $\leftarrow$  /  $\rightarrow$  key to select the channel (CH1 or CH2), press the  $\leftarrow$  key to export the recording file of the selected channel onto the U disk. The directory is **ODPXXXX\Record\_Auto** (ODPXXXX is the model).

- (3) Press the  $\downarrow$  key to select **Display** submenu. Press the  $\leftarrow$  /  $\rightarrow$  key to select **Graph** or **Table**.

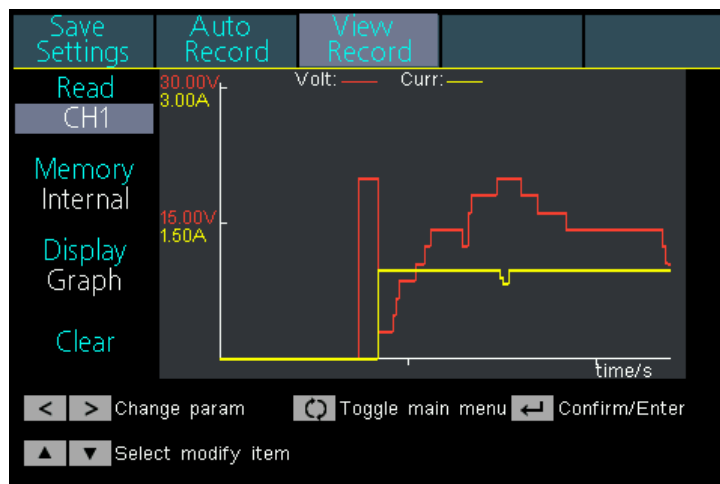

Graph display mode

NO.	Volt	Curr	Power
61	8.708	1.998	17.395
62	8.708	1.998	17.395
63	10.605	1.998	21.184
64	10.605	1.998	21.185
65	10.605	1.998	21.185
66	12.510	1.998	24.990
67	12.512	1.998	24.993
68	14.406	1.998	28.776
69	14.406	1.998	28.776
70	14.405	1.998	28.774

Table display mode

- (4) Press the  $\downarrow$  key to select **Clear** submenu. Press the  $\leftarrow$  key to clear the recording file.

## 4.7 Sense mode

Sense mode can only be applied to CH1.

## 4. Front Panel Operation

In order to ensure the accuracy of the voltage drop while outputting a high current, the power supply was designed with a Sense mode. In Sense mode, the system automatically compensates the voltage drop in the load leads, so as to ensure the specified output value can be consistent with the value received by the load. See the connections below.

### Note:

- Connect the load to the output terminals using separate connecting wires.
- Keep the wire-pair as short as possible, and twist it to reduce lead inductance and noise pickup.
- Do NOT bundle the sense wire-pair together with the load leads; keep the load wires and sense wires separate.

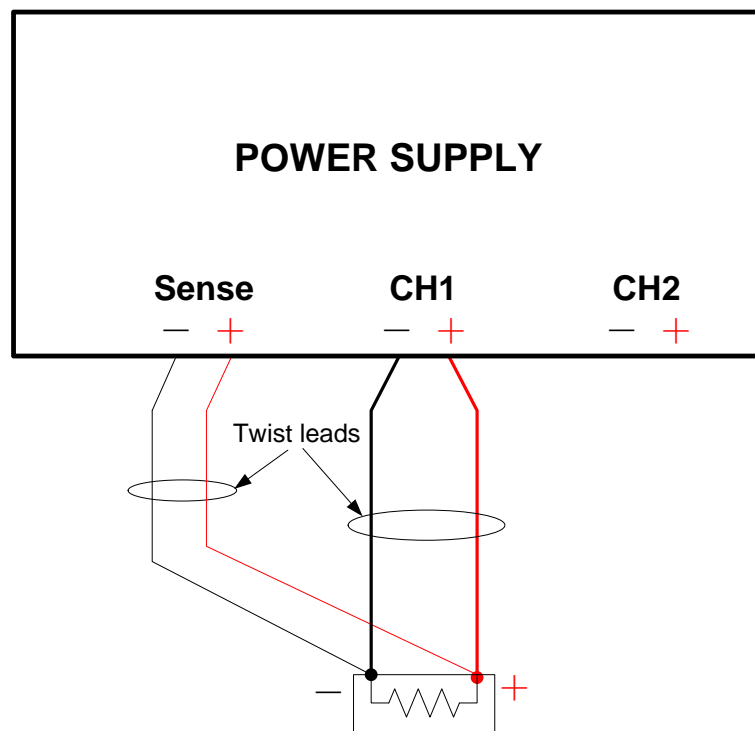

### To set the Sense mode:



- (1) Press the **Utility** key. The **Output mode** menu is selected.
- (2) To enable the Sense mode, press the **Enter** key, a warning message will prompt that short-circuit the output terminal is forbidden on Sense mode. During the message is being displayed, press the **Left Arrow** key to set it as ON.
- (3) To disable the Sense mode, press the **Enter** key to set it as OFF.

## 4.8 Utility Settings





### 4.8.1 Language

Press the **Utility** key, turn the **knob** to select **[Utility]**. The **Language** sub menu is selected. Press the **Left Arrow** / **Right Arrow** key to choose the desired language. The supported languages include: Chinese, English and so on.





## 4.8.2 Brightness

Press the **Utility** key, turn the knob to select [Utility]. Press the  key to select **Brightness** submenu. Press the  /  key to adjust the screen brightness. The brightness can be set to 0%, 25%, 50%, 75%, 100%.

## 4.8.3 Beeper

Press the **Utility** key, turn the knob to select [Utility]. Press the  key to select **Beeper** submenu. Press the  /  key to turn on/off the beeper. When the beeper is on, the icon  will be lighted on the status bar. When the system prompts the instrument will make a buzzing sound, e.g. cutting off the output due to O.V.P/O.C.P.

## 4.8.4 Clock



Press the **Utility** key, turn the knob to select [Utility]. Press the  key to select **Clock** submenu. Use the **numeric keys** to input, press the  key to confirm. Press the  /  key to move the cursor.

## 4.9 System Info

### 4.9.1 View System Information

Press the **Utility** key, turn the knob to select [Info]. The **Info** sub menu is selected. You can view the version, serial number, and checksum.

### 4.9.2 Set as Default

Press the **Utility** key, turn the knob to select [Info]. Press the  key to select **Default** submenu. Press the  key to use the factory defaults, see table below.

Output settings	Output	VOLT	CURR
	CH1	12 V	2 A
	CH2	3.3 V	0.5 A

Limit settings	Output	VOLT	CURR
	CH1	MAXOUT	MAXOUT
	CH2		

Utility	Output mode		Independent mode	
	Brightness		50%	
	Beeper		On	
	Port	Serial	Baud	115200
			Data Bits	8
			Odd-Even	None

#### 4.Front Panel Operation

		Stop Bits	1
	LAN Set	IP	192.168.001.099
		Subnet Mask	255.255.255.000
		Gateway	192.168.001.001
		Port	3000

Record	Save Settings	Memory	Internal
		Save	CH1
	Auto Record	Memory	Internal
		Interval	1
		Points	1000
		Record Status	CH1
	View Record	Read	CH1
		Memory	Internal
		Display	Graph

Program	Data view	Memory	Internal	
	Output Set	Cycle Mode	Order	
		Start Point	1	
		Stop Point	100	
	Data process	Graph process	SET: VOLT,CURR READ: VOLT,CURR	

#### 4.9.3 Update

Use the front-panel USB port to update your instrument firmware using a USB memory device.



**USB memory device requirements:** This instrument only supports a USB memory device with a FAT32 file system. If the USB memory device doesn't work properly, format it into the FAT32 format and try again; or try another USB memory device.



**Caution:** Updating your instrument firmware is a sensitive operation, to prevent damage to the instrument, do not power off the instrument or remove the USB memory device during the update process.

**To update your instrument firmware, do the following:**

- (1) Press the **Utility** key, turn the knob to select **[Info]**. The **Info** sub menu is selected. You can view the model and firmware version.
- (2) From a PC, visit [www.owon.com.cn](http://www.owon.com.cn) and check if the website offers a newer firmware version. Download the firmware file. The file name must be ODPFW.upp. Copy the firmware file onto the root directory of your USB memory device.

- (3) Insert the USB memory device into the front-panel USB port on your instrument. If the status icon  appears on the left of the screen, the USB memory device is installed successfully.
- (4) Press the **Utility** key, turn the knob to select **[Info]**. Press the  key to select **Update** submenu. Press the  key.
- (5) The instrument displays a message telling you not to remove the USB device or power off the instrument until the update process is complete. The progress bar of the screen indicates the update process is in progress.
 













**Note:** A firmware update usually takes approximately a minute. Do not remove the USB memory device during the update process. If you accidentally removed the USB memory device during the update process, do not power off the instrument. Repeat the installation process from step 3.
- (6) Wait until the instrument displays "Firmware upgrade success.", and then it will reboot automatically.
 

**Note:** If the operation complete message is not displayed, do not power off the instrument. Repeat the installation process from step 2 using a different type of USB memory device.
- (7) Remove the USB memory device from the front-panel USB connector.
- (8) Press the **Utility** key, turn the knob to select **[Info]**. The **Info** sub menu is selected, view the firmware version. Confirm that the firmware has been updated.

## 4.10 Port Settings

### 4.10.1 Serial port







Press the **Utility** key, turn the knob to select **[Port Set]**. The **Serial** sub menu is selected.

- (1) Press the  key to enter sub menu. The **Baud** is selected. Press the  /  key to select the desired baud rate from 1200, 2400, 4800, 9600, 19200, 38400, 57600 or 115200. The default is 115200. Make sure that the baud rate matches that of the computer.
- (2) Press the  key to select **Data Bits**. Press the  /  key to select 6, 7, or 8.
- (3) Press the  key to select **Odd-Even**. Press the  /  key to select None, Odd, or Even.
- (4) Press the  key to select **Stop Bits**. Press the  /  key to 1 or 2.  
Press  to back to sub menu selection.

### 4.10.2 LAN Set

Press the **Utility** key, turn the knob to select **[Port Set]**. Press the  key to select **Lan Set** submenu.

- (1) Press the  key to enter edit mode. Set the IP address, subnet mask, gateway,



and port. Use the **numeric keys** to input, press the  key to confirm. Press the  /  key to move the cursor left and right. Press the  /  key to move the cursor up and down. Press  to back to sub menu selection.

(2) Restart the instrument for the parameter changes to take effect.

### 4.10.3 LCD Test

The instrument has a screen self test function, which can test the LCD screen.



Press the **Utility** key, turn the knob to select **[Port Set]**. Press the  key to select **Lcd Test** submenu.

- (1) Press the  key to enter the screen test interface.
- (2) Press the  key to switch the color between red, green, and blue. Observe if the screen has severe color shift, spot, scuffing, or other defect.
- (3) Press the  key to exit the test.

### 4.10.4 Key Test

The instrument provides the key self testing, which can test the keys on the front panel.

Press the **Utility** key, turn the knob to select **[Port Set]**. Press the  key to select **Key Test** submenu.

- (1) Press the  key to enter the key test interface.
- (2) Each shape on the test interface represents a front panel key. Press any front panel key, the corresponding shape on the test interface will turn green.
- (3) Press the  key to exit the test.

## 5. Troubleshooting

### 1. The instrument is powered on but no Display.

- Check if the power is connected properly.
- Check if the fuse which is below the AC Power socket is used appropriately and in good condition (the cover can be pried open with a straight screwdriver).
- Restart the instrument after the steps above.
- If the problem still exists, please contact **OWON** for our service.

### 2. The output is abnormal:

- Check if the output voltage is set to 0V. If so, set it to other value.
- Check if the output current is set to 0A. If so, set it to other value.
- When in programmable output status, check if there is any voltage/current value is set to 0. If so, set it to other value.
- If the problem still exists, please contact **OWON** for our service.

### 3. Cannot identify the USB device correctly:

- Check if the USB device is in good condition.
- Check if the used USB device is a flash device, note a hard disk cannot be supported.
- Restart the instrument and insert your USB flash device again.
- If the problem still exists, please contact **OWON** for our service.

## 6. Technical Specifications

The specifications below are based on the instrument having run for at least 30 minutes continuously under the specified operating temperature.

Specifications		CH1	CH2	
Output Ratings (0°C-40°C)	ODP3122	Voltage	0 - 30V	0 - 6V
		Over Voltage Protection	31V	6.6V
		Current	0 - 12A	0 - 3A
		Over Current Protection	12.1A	3.1A
		Power	360W	18W
	ODP6062	Voltage	0 - 60V	0 - 6V
		Over Voltage Protection	61V	6.6V
		Current	0 - 6A	0 - 3A
		Over Current Protection	6.1A	3.1A
		Power	360W	18W
Load Regulation		Voltage	$\leq 0.01\% + 3\text{mV}$	
		Current	$\leq 0.01\% + 3\text{mA}$	
Line Regulation		Voltage	$\leq 0.01\% + 3\text{mV}$	
		Current	$\leq 0.01\% + 3\text{mA}$	
Settings Resolution		Voltage	1mV	
		Current	1mA	
Read Back Resolution		Voltage	1mV	
		Current	1mA	
Settings Accuracy (Within 12 months) (25°C±5°C)		Voltage	$\leq 0.03\% + 10\text{mV}$	
		Current	$\leq 0.1\% + 8\text{mA}$	$\leq 0.1\% + 5\text{mA}$
Read Back Accuracy (25°C±5°C)		Voltage	$\leq 0.03\% + 10\text{mV}$	
		Current	$\leq 0.1\% + 8\text{mA}$	$\leq 0.1\% + 5\text{mA}$
Noise and Ripple (20Hz-20MHz)		Voltage (Vp-p)	$\leq 4\text{mVp-p}$	$\leq 3\text{mVp-p}$
		Voltage (rms)	$\leq 1\text{mVrms}$	
		Current (rms)	$\leq 5\text{mA rms}$	$\leq 4\text{mA rms}$
Output Temperature Coefficient (0°C-40°C)		Voltage	$\leq 0.03\% + 10\text{mV}$	
		Current	$\leq 0.1\% + 5\text{mA}$	
Read Back Temperature Coefficient		Voltage	$\leq 0.03\% + 10\text{mV}$	
		Current	$\leq 0.1\% + 5\text{mA}$	

## 7. Appendix

<b>Programmable output</b>	Storage	1M points
	Groups saved in internal memory	100 groups
	Time setting	Second
<b>Data Record Function</b>	10k groups of data (voltage, current, power)	
<b>Ports</b>	USB Host, USB Device, RS232, LAN	

### Display

Display Type	4 inch colored LCD (Liquid Crystal Display)
Display Resolution	480 (Horizontal) × 320 (Vertical) Pixels
Display Colors	65536 colors, TFT screen

### Power

Supply	110 VAC ± 10% or 220 VAC ± 10%; AC input 50/60Hz	
Fuse	110 V	250 V, F10A
	220 V	250 V, F5A

### Environment

Temperature	Working temperature: 0°C ~ 40°C Storage temperature: -20°C ~ 60°C
Relative Humidity	≤ 90%
Height	Operating: 3,000 m Non-operating: 15,000 m
Cooling Method	Fan cooling

### Mechanical Specifications

Dimension	250mm × 158mm × 358mm (W*H*D)
Weight	Approx. 12.0 kg (without accessories)

### Interval Period of Adjustment:

One year is recommended for the calibration interval period.

# 7. Appendix

## 7.1 Appendix A: Packaging

(The accessories subject to final delivery.)

**Standard Accessories:**



**Power Cord**



**CD Rom**



**User Manual**



**USB Cable**



**Fuse**

**Options:**



**Banana plug to crocodile clip test leads**

## 7.2 Appendix B: General Care and Cleaning

### General Care

Do not store or leave the instrument where the liquid crystal display could be exposed to direct sunlight for long periods of time.

**Caution:** To avoid any damage to the instrument, do not exposed it to any sprays, liquids, or solvents.

### Cleaning

Inspect the instrument as often as operating conditions require.

To clean the instrument exterior, perform the following steps:

1. Wipe the dust from the instrument surface with a soft cloth. Take care not to scratch the transparent LCD protection screen when cleaning.
2. Disconnect power before cleaning your instrument. Clean the instrument with a damp soft cloth (not dripping with water). It is recommended to clean with soft detergent or fresh water. To avoid damage to the instrument, do not use any corrosive chemical cleaning agents.



**Warning:** Before re applying power, ensure that the instrument is completely dry, avoiding any electric shock or electrical short circuit resulting from moisture.

---