

LAB

FEM1.02\_..18\_..  
OPERATING INSTRUCTIONS

# SIMDOS<sup>®</sup> 02

## DIAPHRAGM METERING PUMP



Before operating the pump and the accessories, please read the operating instructions and pay attention to the safety precautions.

KNF Flodos AG  
Wassermatte 2  
6210 Sursee, Switzerland  
Tel +41 (0)41 925 00 25  
Fax +41 (0)41 925 00 35  
[www.knf.com](http://www.knf.com)

| <b>Contents</b>                                      | <b>Page</b> |
|--|-------------|
| <b>1 General points .....</b>                        | <b>5</b>    |
| 1.1 Information on the instructions                  | 5           |
| 1.2 Warnings   | 6           |
| 1.3 Symbols  | 7           |
| 1.4 Disclaimer of liability                          | 8           |
| 1.5 Manufacturer's address                           | 8           |
| 1.6 Year of manufacture                              | 8           |
| 1.7 Other applicable documents                       | 8           |
| 1.8 Copyright  | 8           |
| 1.9 Warranty conditions                              | 8           |
| <b>2 Safety .....</b>                                | <b>9</b>    |
| 2.1 Intended use                                     | 9           |
| 2.2 Reasonably foreseeable misuse                    | 9           |
| 2.3 Owner's responsibility                           | 10          |
| 2.4 Personnel requirements                           | 10          |
| 2.5 Product-specific dangers                         | 11          |
| 2.6 Personal protective equipment                    | 12          |
| 2.7 Safety equipment                                 | 13          |
| 2.8 Disposal   | 13          |
| 2.9 Danger areas                                     | 13          |
| 2.10 Declaration of conformity                       | 14          |
| <b>3 Technical data.....</b>                         | <b>15</b>   |
| 3.1 Items included in delivery                       | 15          |
| 3.2 Storage conditions                               | 15          |
| 3.3 Pump head materials                              | 15          |
| 3.4 Product key                                      | 16          |
| 3.5 Dimensions                                       | 17          |
| 3.6 Installation location requirements               | 18          |
| 3.7 Electrical connections and performance data      | 18          |
| 3.8 Remote control (RC and RC Plus version only)     | 19          |
| 3.9 Remote control via RS 232 (RC Plus version only) | 19          |
| 3.10 Flow rates                                      | 20          |
| 3.11 Other parameters                                | 20          |
| 3.12 Hydraulic connections                           | 20          |
| 3.13 Transferred medium                              | 21          |
| 3.14 Accuracy/ reproducibility                       | 22          |
| <b>4 Assembly and function .....</b>                 | <b>24</b>   |
| 4.1 Metering pump structure                          | 24          |
| 4.2 Operating principle                              | 24          |
| 4.3 Valves   | 25          |
| 4.4 Pump diaphragm                                   | 27          |
| 4.5 Pump head  | 27          |
| 4.6 Operating controls                               | 27          |
| <b>5 Shipment .....</b>                              | <b>32</b>   |
| 5.1 Checking delivery                                | 32          |
| 5.2 Registering a complaint                          | 32          |
| 5.3 Arranging for return                             | 32          |
| <b>6 Installation and initial start-up .....</b>     | <b>33</b>   |
| 6.1 Safety   | 33          |
| 6.2 Installation                                     | 34          |
| 6.3 System setup                                     | 37          |
| 6.4 Initial start-up                                 | 39          |
| <b>7 Operation.....</b>                              | <b>40</b>   |
| 7.1 Safety   | 40          |
| 7.2 Switching pump on / off                          | 41          |
| 7.3 Entering settings                                | 42          |
| 7.4 Setting the operating mode                       | 43          |
| 7.5 Priming the pump                                 | 44          |
| 7.6 Starting the pump                                | 44          |

|           |  |           |
|-----------|--|-----------|
| 7.7       | Interrupting a transferring operation                | 44        |
| 7.8       | Stopping the transferring operation                  | 45        |
| 7.9       | Transferring fluid                                   | 46        |
| 7.10      | Setting metering operation                           | 46        |
| 7.11      | Setting the fluid type                               | 47        |
| 7.12      | To calibrate the pump                                | 48        |
| 7.13      | Cycle metering mode                                  | 49        |
| 7.14      | Setting the system                                   | 49        |
| 7.15      | Back to main menu                                    | 49        |
| 7.16      | Select language setting                              | 50        |
| 7.17      | Activate autostart                                   | 50        |
| 7.18      | Set contrast   | 50        |
| 7.19      | Resetting the pump (Reset)                           | 51        |
| 7.20      | Shutting down the pump in an emergency               | 51        |
| <b>8</b>  | <b>RC version (remote control)</b> .....             | <b>52</b> |
| 8.1       | Remote control analog input                          | 53        |
| 8.2       | Digital input 1, Start / Stop                        | 55        |
| 8.3       | Digital input 2 Reset / Prime / Foot Switch          | 57        |
| 8.4       | Digital output                                       | 59        |
| <b>9</b>  | <b>RC Plus version (serial communication)</b> .....  | <b>60</b> |
| <b>10</b> | <b>Cleaning and maintenance</b> .....                | <b>61</b> |
| 10.1      | Safety   | 61        |
| 10.2      | Cleaning the pump                                    | 62        |
| 10.3      | Maintenance plan                                     | 63        |
| 10.4      | Cleaning / replacing valve plates and pump diaphragm | 64        |
| 10.5      | Checking that pump is leak-tight                     | 70        |
| <b>11</b> | <b>Shutdown</b> .....                                | <b>71</b> |
| 11.1      | Safety   | 71        |
| <b>12</b> | <b>Troubleshooting</b> .....                         | <b>72</b> |
| 12.1      | Safety   | 72        |
| 12.2      | Displaying of error messages                         | 72        |
| 12.3      | Rectifying transfer problems                         | 73        |
| <b>13</b> | <b>Spare parts and accessories</b> .....             | <b>74</b> |
| 13.1      | Spare parts  | 74        |
| 13.2      | Hoses  | 74        |
| 13.3      | Pressure control valve                               | 74        |
| 13.4      | Filter   | 74        |
| 13.5      | Foot switch  | 74        |
| 13.6      | Fastening material                                   | 74        |
| <b>14</b> | <b>Decontamination declaration</b> .....             | <b>75</b> |

# 1 General points

## 1.1 Information on the instructions

|                                   |   |
|-----------------------------------|---|
| Contents                          | The operating instructions contain important notes on how to use the pump. In order to ensure safe working and proper functioning it is essential to observe all the specified safety precautions.                                    |
| Storage location                  | These operating instructions are part of the product, and must be stored in its immediate vicinity in a location accessible to personnel at all times.  |
| Passing on                        | These operating instructions are part of the product, and must be passed on to the next owner if the device is resold.  |
| Project pumps                     | Customer-specific project pumps (pump models which begin with "PL" or "PML") may differ from the operating instructions, in which case the agreed specification is also applicable. It is listed with the other applicable documents. |
| Illustrations in the instructions | <p>Illustrations in these operating instructions may be to scale, but do not have to be.</p> <p>The illustrations may differ slightly from the actual product.</p>  |

## 1.2 Warnings

Warnings in the operating instructions are identified with the danger symbol, keywords and colours. These provide an indication of the extent of the danger.



### **⚠ DANGER**

Indicates a dangerous situation which may lead directly to death or serious injury if it is not avoided.



### **⚠ WARNING**

Indicates a dangerous situation which may lead to death or serious injury if it is not avoided.



### **⚠ CAUTION**

Indicates a dangerous situation which may lead to moderate or minor injuries if it is not avoided.

### **NOTE**

Indicates a situation which may cause damage to property if it is not avoided.

### 1.3 Symbols

The following symbols appear in the operating instructions, on labels on the device, and on its packaging:

|   |  |
|---|--|
| <b>⚠ WARNING</b>  |  |
|  | <b>Danger of injuries and property damage caused by illegible labels</b>   |
|   | The labelling on the device may become illegible with time.  |
|   | <ul style="list-style-type: none"> <li>➤ Maintain labels on the device in a legible condition.</li> <li>➤ Replace any illegible labels.</li> </ul> |

The following symbols in the operating instructions and on the device and its packaging indicate environmental protection considerations:



Recycling



WEEE

Symbol for separate tracking of electrical and electronic devices. The use of this symbol means that this product must not be disposed of with normal household waste.

The following symbols in safety precautions and on the device indicate the nature of the danger:



General danger symbol

Further details of the nature of the danger are provided in the warning highlighted by this symbol.



Electrical danger



Danger of caustic burns or burns



Fire danger



Danger of automatic start-up



This symbol calls for disconnection from the mains.

## 1.4 Disclaimer of liability

In preparing the contents of these operating instructions, account has been taken of applicable regulations.

The manufacturer can accept no liability for any damage or malfunctions caused by failure to follow the operating instructions.

The manufacturer can accept no liability for any damage or malfunctions caused by modification or conversion of the device or improper handling.

The manufacturer can accept no liability for any damage or malfunctions caused by the use of non-approved spare parts and accessories.

## 1.5 Manufacturer's address

KNF Flodos AG  
Wassermatte 2  
6210 Sursee, Switzerland  
Tel +41 (0)41 925 00 25  
Fax+41 (0)41 925 00 35  
www.knf.com

## 1.6 Year of manufacture

The year of manufacture is shown on the device's type plate.

## 1.7 Other applicable documents

The documents listed must also be taken into consideration.

- Chemical resistance list
- Sales documents
- General Trade Conditions

## 1.8 Copyright

The information, texts and illustrations in these operating instructions are protected by copyright. The contents of these operating instructions must not be copied, translated or passed to third parties without the written consent of the manufacturer.

## 1.9 Warranty conditions

The applicable warranty conditions are set out in the General Terms and Conditions of Business and the sales documents.

The warranty does not cover the following:

- Malfunctions caused by particles/fibres in the valve system
- Sticking of the valve system as a result of inadequate flushing



## 2 Safety

### 2.1 Intended use

This pump is intended exclusively for use as follows:

- Transferring and metering liquids.
- Temporary operation in laboratories for research purposes.
- Operation in accordance with the operating parameters specified in the technical data (see Chapter 3) and other applicable documents.
- Transferring media which meet the requirements in the technical data and other applicable documents.
- Operation when fully assembled.
- Upright operation on a firm table top.
- For operation in a basic electromagnetic environment (Residential, light industry, laboratory) according to definition in EN IEC 61326-1.

### 2.2 Reasonably foreseeable misuse

The pump must not be

- operated in an explosive atmosphere.
- used to transfer explosive media.
- used to produce foodstuffs or pharmacological products. Additional certifications are required for this purpose.
- used to transfer media whose compatibility with the pump head, valves and seals has not been demonstrated.

Restrictions:

- When used in an industrial electromagnetic environment, according to definition in EN IEC 61326-1, interference may occur.

### 2.3 Owner's responsibility

The operator is responsible for compliance with the safety precautions in the present operating instructions and with any safety, accident prevention and environmental protection regulations which apply to the medium to be transferred and the range of applications of the device.

These include the following in particular:

- The operator must perform a risk assessment to identify any additional risks which may arise from the specific working conditions at the pump's installation location and the nature of the medium to be transferred. He/she must convert these into instructions for operating the device.
- The operator must ensure that any employees working with the pump have read the operating instructions.
- The operator must train his personnel at regular intervals and inform them of the risks involved.
- The operator must provide his personnel with the necessary protective equipment as specified in the safety data sheet for the medium to be transferred.
- The operator must maintain the pump in perfect working order.
- The operator must ensure compliance with the maintenance intervals described in the operating instructions.

### 2.4 Personnel requirements



|  |
|--|
| <b>⚠ WARNING</b>   |
| <p><b>Danger of injuries and property damage caused by insufficiently qualified staff</b></p> <p>Improper use of the pump may result in serious injury and damage to property.</p> <ul style="list-style-type: none"> <li>➤ Any activities must only be performed by adequately qualified personnel</li> </ul> |

The following qualifications are specified for various activities in the operating instructions:

|                        |  |
|------------------------|--|
| Trained personnel      | These have been instructed in the task assigned to them and made aware of potential dangers and risks. This training is the minimum qualification for working on the device. Where no other qualification is specified, the activity must be performed by a trained individual as a minimum. |
| Specialist personnel   | The specialist training, knowledge and experience of such personnel, together with their knowledge of the relevant regulations, standards and directives, allow them to perform their assigned duties correctly, and to independently identify and avoid potential dangers and risks.        |
| Unauthorised personnel | Individuals whose reactions have been impaired by the consumption of medicines, alcohol, drugs or by other causes and conditions are not authorised to perform activities on the device.   |

## 2.5 Product-specific dangers

This Chapter describes residual risks that have been identified in a risk assessment. Safety precautions and warnings in this Chapter and in other Chapters in the operating instructions must be observed in order to avoid dangerous situations.

### DANGER



#### **Danger of injuries and property damage caused by leaks in connections and the pump head**

Poisoning and caustic burns, or undesirable reactions caused by escaping hazardous materials

- Maintain the tightening torque of connections (see Hydraulic connections)
- Check tightening torque of head screws regularly
- Only use pump if it is in perfect working order
- Operate pump in accordance with the technical data

### DANGER



#### **Danger of injuries and property damage caused by medium escaping from the discharge outlet**

Poisoning and caustic burns, or undesirable reactions caused by escaping hazardous materials

- Place the pump in a suitable collecting vessel
- Never close the discharge outlet
- If medium escapes from the pump's discharge outlet, stop using the pump and contact your KNF dealer

### DANGER



#### **Risk of fire from escaping flammable media**

Escaping or leaking flammable media can produce a combustible environment.

- Take fire protection precautions that are appropriate for the transferred media
- Keep ignition sources away
- Keep suitable extinguishers accessible
- Use means of fire detection

### WARNING



#### **Danger of serious injuries or property damage caused by escaping media in the event of overpressure on the suction side**

Excessive pressure on the suction side will result in uncontrolled escaping of the fluid, even if the pump is not operating

- Avoid overpressure on the suction side
- Fit a pressure control valve (see Section 6.3.3)

**⚠ CAUTION****Deviating metering accuracy**

The metered volume may deviate from the set value due to gases, particles, or cavitation in the fluid system.

- Use a pre-filter, especially for media containing solid particles or fibers (see Chapter 13)
- Clean the valve disc/pump head (see Section 10.4)
- Ventilate the pump and system well
- Set the liquid type, for highly viscous and outgassing media, see Section 7.11

**⚠ CAUTION****Deviating metering accuracy**

Transferring media containing particles larger than 70 µm may block the valves in the pump head.

- Use a pre-filter, especially for media containing solid particles or fibers (see Chapter 13)
- Monitor the metering
- Clean the valve disc/pump head (see Section 10.4)

**2.6 Personal protective equipment**

Special protective equipment must be used when performing certain tasks. These are indicated separately in the individual Chapters.

Where the wearing of protective equipment is concerned it is essential to observe the safety data sheet for the medium to be transferred.

The following symbols appear in the working area or in the operating instructions:

**Safety gloves**

to protect skin from contact with the transferred medium in accordance with the safety data sheet.

**Safety glasses**

to protect the eyes from contact with the transferred medium in accordance with the safety data sheet.

**Face protection**

to protect skin and eyes from contact with the transferred medium in accordance with the safety data sheet.

## 2.7 Safety equipment

### 2.7.1 Safety diaphragm with intermediate flange

#### **⚠ DANGER**

##### **Danger of injuries and property damage caused by medium escaping from the discharge outlet**

Poisoning and caustic burns, or undesirable reactions caused by escaping hazardous materials

- Place the pump in a suitable collecting vessel
- Check the discharge outlet regularly for leaks
- Never close the discharge outlet (see Fig. 1)
- If medium escapes from the pump's discharge outlet, stop using the pump and contact your KNF dealer

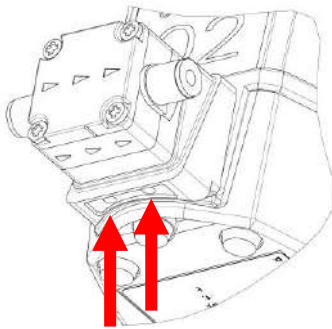

Fig. 1: Discharge outlet

In the event that the pump diaphragm ruptures, the safety diaphragm prevents the transferred medium from penetrating into the pump. If the pump diaphragm ruptures, the transferred medium is channelled out of the pump through the discharge outlet (see Fig. 1).

### 2.7.2 Emergency Stop

Pulling out the mains plug acts as an Emergency Stop. If the pump is installed permanently, an Emergency Stop and a maintenance switch must be fitted.

### 2.7.3 Pressure control valve (optional)

In the event of overpressure on the suction side, the pump allows the medium to flow through it freely. The pressure control valve maintains a counterpressure of 0.5 bar and prevents the transferred medium from escaping. The pressure control valve is to be used on the pressure side (see Section 6.3.3)

## 2.8 Disposal

Store the vacuum system and all replacement parts in accordance with the environmental protection regulations. Observe both the respective national and international regulations here. This applies in particular to parts that are contaminated with toxic substances.

If you no longer need your packaging materials (e.g. for return shipment or other transport of the vacuum system), dispose of them in an environmentally friendly manner.

This product is marked in conformance with the EU directive on the disposal of Waste Electrical and Electronic Equipment (WEEE). Old devices must not be disposed of with household waste. Proper disposal and recycling help to protect natural resources and the environment. The end user is responsible for disposing of old devices according to the national and international regulations. Alternatively, KNF products (old devices) may also be returned to KNF for a fee.

## 2.9 Danger areas

When transferring corrosive, poisonous, ionising, inflammable or biological media, escaping medium may cause a hazard.

The pump danger area should be limited by safe workplaces. Safe workplaces should comply with the requirements of local work safety regulations.

Environmental  
protection  
WEEE



## 2.10 Declaration of conformity



### EG/EU/UK – Konformitätserklärung EC/EU/UK Declaration of Conformity

Hiermit erklärt der Hersteller:

Herewith the manufacturer declares:

KNF Flodos AG, Wassermatte 2, CH-6210 Sursee, Schweiz

dass folgende Produkte:

that the following products:

| Bezeichnung<br>Denomination | Modell<br>Model | Typ<br>Type            |
|-----------------------------|-----------------|------------------------|
| Labor Membran -Dosierpumpen | FEM 1.02        | .18S/ .18RC/ .18RCP    |
| Labor Membran -Dosierpumpen | FEM 1.10        | .18S2/ .18RC2/ .18RCP2 |
| Labor Membran -Dosierpumpen | UFEM 1.10       | .18S2/ .18RC2/ .18RCP2 |

(Seriennummer siehe Typenschild)

(Serial number see type label)

allen einschlägigen Bestimmungen folgender Richtlinien / Verordnungen entsprechen:  
comply with all relevant provisions of the following Directives / Regulations:

Richtlinie 2006/42/EG (Maschinenrichtlinie)  
Directive 2006/42/EC (machinery directive)  
UK Regulation S.I. 2008/1597 Supply of Machinery (Safety)

Richtlinie 2014/30/EU (EMV)  
Directive 2014/30/EU (EMC)  
UK Regulation S.I. 2015/1091 Electromagnetic Compatibility

Richtlinie 2011/65/EU (RoHS)  
Directive 2011/65/EU (RoHS)  
UK Regulation S.I. 2012/3032 Restriction of the Use of Certain Hazardous Substances in Electrical and Electronic Equipment

Folgende harmonisierte Normen wurden zugrunde gelegt:

The following harmonized standards have been applied:

| Fundstelle<br>Reference | Ausgabedatum<br>Release date | Titel<br>Title  |
|-------------------------|------------------------------|---|
| EN IEC 63000            | 2018                         | Technische Dokumentation zur Beurteilung von Elektro- und Elektronikgeräten hinsichtlich der Beschränkung gefährlicher Stoffe |
| EN ISO 12100            | 2011                         | Sicherheit von Maschinen - Allgemeine Gestaltungsgrundsätze - Risikobeurteilung und Risikominderung                           |
| EN IEC 61326-1          | 2021                         | Elektrische Mess-, Steuer-, Regel- und Laborgeräte - EMV-Anforderungen - Teil 1: Allgemeine Anforderungen                     |
| EN 61010-1              | 2010/A1:2019                 | Sicherheitsbestimmungen für elektrische Mess-, Steuer-, Regel- und Laborgeräte - Teil 1: Allgemeine Anforderungen             |

Bevollmächtigte Person für die Zusammenstellung der technischen Unterlagen:

Authorised person to compile the relevant technical documentation:

Daniel Kohli, Product Development, KNF Flodos AG, Wassermatte 2, CH-6210 Sursee, Schweiz

Sursee, 11.07.2024

Ort, Datum (TT.MM.JJJJ)  
Place, date, (dd.mm.yyyy)

Leiter Forschung & Entwicklung CTO Stephan Kaufmann  
Chief Technology Officer

### 3 Technical data

#### 3.1 Items included in delivery

- SIMDOS metering pump
- Mains plug
- Operating manual
- Abbreviated instructions
- Connection kit: Hose and screw-in fittings
- Filter
- Remote control cable (RC and RCP version only)
- D-sub control cable (RCP version only)

#### 3.2 Storage conditions

- Pumps must be stored in a dry place and protected from contamination.
- The storage temperature must be between 5°C and 40°C.
- The pump is supplied with protective caps. These protective caps must be fitted during storage.
- Store pump upright and with protection.

#### 3.3 Pump head materials

The type designation **KT** stands for:

| Assembly            | Material <sup>1)</sup>       | Medium contact |
|---------------------|------------------------------|----------------|
| Pump head           | PP                           | Yes            |
| Valve plate / seals | FFKM                         | Yes            |
| Diaphragm           | PTFE-coated<br>EPDM membrane | Yes            |
| Included Filter     | PEEK*                        | Yes            |
| Housing             | PP, TPE, PC                  | No             |

Tab. 1: KT materials

<sup>1)</sup> according to DIN ISO 1629 and 1043.1  
\*material for housing and filter mesh

The type designation **TT** stands for:

| Assembly            | Material <sup>1)</sup>       | Medium contact |
|---------------------|------------------------------|----------------|
| Pump head           | PVDF                         | Yes            |
| Valve plate / seals | FFKM                         | Yes            |
| Diaphragm           | PTFE-coated<br>EPDM membrane | Yes            |
| Included Filter     | PVDF*                        | Yes            |
| Housing             | PP, TPE, PC                  | No             |

Tab. 2: TT materials

<sup>1)</sup> according to DIN ISO 1629 and 1043.1  
\*material for housing and filter mesh

The type designation **FT** stands for:

| Assembly            | Material <sup>1)</sup> | Medium contact |
|---------------------|------------------------|----------------|
| Pump head           | PTFE                   | Yes            |
| Valve plate / seals | FFKM                   | Yes            |
| Diaphragm           | FFKM                   | Yes            |
| Included Filter     | PEEK*                  | Yes            |
| Housing             | PP, TPE, PC            | No             |

Tab. 3: FT materials

<sup>1)</sup> according to DIN ISO 1629 and 1043.1  
\*material for housing and filter mesh

The type designation **ST** stands for:

| Assembly            | Material                  | Medium contact |
|---------------------|---------------------------|----------------|
| Pump head           | 1.4404                    | Yes            |
| Valve plate / seals | FFKM <sup>1)</sup>        | Yes            |
| Diaphragm           | PTFE-coated EPDM membrane | Yes            |
| Included Filter     | PEEK*                     | Yes            |
| Housing             | PP, TPE, PC <sup>1)</sup> | No             |

Tab. 4: ST materials

<sup>1)</sup> according to DIN ISO 1629 and 1043.1  
\*material for housing and filter mesh

### 3.4 Product key

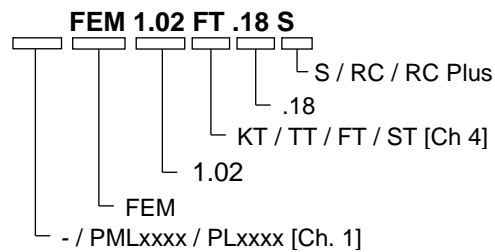

| Description       | Meaning   |
|-------------------|---|
| PML / PL          | Customer-specific designs   |
| FEM               | Flodos Electronic Metering (designation for metering pumps)   |
| 1.02              | Pump type   |
| KT / TT / FT / ST | Head material   |
| .18               | Laboratory device with housing  |
| S / RC / RC Plus  | S without remote control<br>RC with remote control (Remote Control)<br>RC Plus with RS 232 interface and remote control |

Tab. 5: Product key



### 3.5 Dimensions

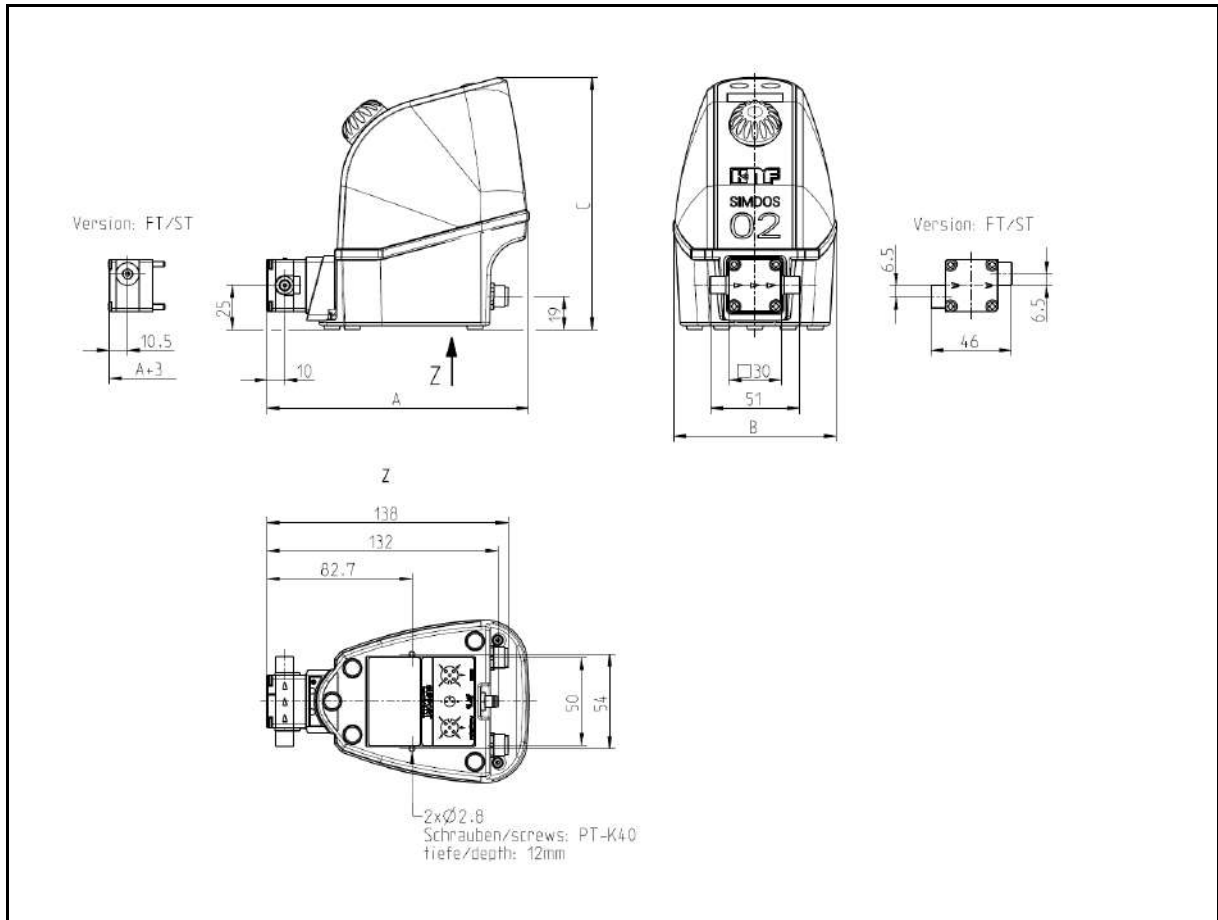

Fig. 2: Mounting measurements (measurement tolerances as per DIN ISO 2768-1, tolerance class V)

| Parameter                   | Value (metric) | Value (imperial) |
|-----------------------------|----------------|------------------|
| Width (A)                   | 150 mm         | 6.102 inches     |
| Depth (B)                   | 93 mm          | 3.740 inches     |
| Height (C)                  | 144 mm         | 5.708 inches     |
| Weight of pump <sup>1</sup> | 0.9 kg         | 1.98 lb          |

Tab. 6: Dimensions

#### Type plate

The type plate is on the bottom of the device. It contains the following information:

- Manufacturer's address
- Type
- Serial Number
- Design pressure
- CE and UKCA mark
- Year of manufacture
- Electrical connection data

<sup>1</sup> Differences are possible depending on the project

### 3.6 Installation location requirements

The pump is designed to be operated in an upright position.

#### NOTE

An unsuitable location may cause damage to the device

- Install in a dry place
- Protect the installation location of the pump from water in the form of rain, spray, splashes and drips
- Do not operate the pump in an aggressive or inflammable environment
- Choose a safe location (a level, flat surface) for the pump
- Place the pump in a suitable collecting pan
- If the stability of the pump cannot be ensured, fasten the pump in place using two screws
- Make sure that the hose connections can be fitted without strain on the hoses
- Protect the pump against shocks, impacts and strong vibrations

### 3.7 Electrical connections and performance data

#### 3.7.1 Power supply unit

| Parameter                    | Value                          |
|------------------------------|--------------------------------|
| Nominal mains voltage AC [V] | 100 – 240 V AC +/- 10 %        |
| Frequency [Hz]               | 50 – 60                        |
| Max. power consumption [W]   | 40                             |
| Pump DC voltage [V]          | 24                             |
| Pump protection type         | IP 40                          |
| Power supply protection      | Electronic overload protection |

Tab. 7: Electrical data power supply unit

#### 3.7.2 Pump

| Parameter                                 | Value                          |
|---|--------------------------------|
| Pump DC voltage [V]                       | 24                             |
| Max. current consumption, DC RMS 24 V [A] | 0.4                            |
| Max. short-term peak current [A]          | 1.7                            |
| Pump protection                           | Electronic overload protection |
| Pump protection type                      | IP 65                          |

Tab. 8: Electrical data pump

### 3.8 Remote control (RC and RC Plus version only)

| Parameter   | Value   |
|---|---|
| <i>Analog input</i>                                 |   |
| Signal range, (100%)<br>for 1 – 100% of full scale  | 0 – 5 V, 0 – 10 V,<br>0 – 20 mA, 4 – 20 mA  |
| Signal range, (30%)<br>for 0.3 – 30% of full scale  | 0 – 5 V, 0 – 10 V,<br>0 – 20 mA, 4 – 20 mA  |
| Signal range, (15%)<br>for 0.15 – 15% of full scale | 0 – 5 V, 0 – 10 V,<br>0 – 20 mA, 4 – 20 mA  |
| Input resistance [ $\Omega$ ]                       | 13.9 k $\Omega$ at 0 – 10 V<br>13.9 k $\Omega$ at 0 – 5 V<br>470 $\Omega$ at 4 – 20 mA<br>470 $\Omega$ at 0 – 20 mA |
| Electric strength [V] TTL                           | 24 V DC   |
| <i>Digital input</i>                                |   |
| Signal range  | Pull up at 24 V   |
| Voltage [V] TTL                                     | 24 V DC   |
| Low level (ON)                                      | < 0.8 V = low   |
| High level (OFF)                                    | > 2.0 V = high  |
| <i>Digital output <sup>*1</sup></i>                 |   |
| Voltage<br>open collector [V] TTL                   | 24 V DC   |
| Load capability<br>open collector [mA] TTL          | 10 mA   |

Tab. 9: Remote control

<sup>\*1</sup> To capture pulse signals like Mot. Pul. And Vol. Pul. with a (1 ms) duration, a sampling rate > 2 kHz or a counter input with edge detection is necessary.

### 3.9 Remote control via RS 232 (RC Plus version only)

| Parameter                 | Value       |
|---------------------------|-------------|
| <i>RS 232 interface</i>   |             |
| TX – RS232                |             |
| RX – RS232                |             |
| Ground                    |             |
| <i>Settings (factory)</i> |             |
| Baud rate                 | 9600 Kbit/s |
| Data                      | Bits 8      |
| Parity                    | No          |
| Stop                      | Bit 1       |
| Mode                      | Half duplex |

Tab. 10: RS 232 interface

### 3.10 Flow rates

| Parameter                     | Value          |
|-------------------------------|----------------|
| Flow rate [ml/min]            | 0.03 - 20      |
| Max. metering volume [ml]     | 0.03 - 1000    |
| Metering time [mm:ss] [hh:mm] | 1s – 99h 59min |
| Permissible pressure [bar g]  | 6              |
| Suction head [mWG]            | 2              |

Tab. 11: Hydraulic ratings

#### NOTE

The pump has been calibrated to its nominal flow rate in the factory. The specified flow rate is for water at 20°C with free discharge flow. The flow rate may differ from the calibrated value depending on the medium, its viscosity, density and temperature, pressure and installation type (e.g. cross-section constrictions).

- For accurate metering, calibrate the pump in the system (see Section 7.12)

### 3.11 Other parameters

| Parameter                            | Value   |
|--------------------------------------|---|
| Permissible ambient temperature [°C] | +5 to +40                                     |
| Service life [h]                     | 10,000<br>(100 million strokes)<br>or 5 years |
| Noise level                          | < 40 dBA                                      |

Tab. 12: Other parameters

### 3.12 Hydraulic connections

| Pump type      | Connection type               |
|----------------|-------------------------------|
| FEM 1.02 KT.18 | Internal thread UNF 1/4" – 28 |
| FEM 1.02 TT.18 | Internal thread UNF 1/4" – 28 |
| FEM 1.02 FT.18 | Internal thread UNF 1/4" – 28 |
| FEM 1.02 ST.18 | Internal thread UNF 1/4" – 28 |

Tab. 13: Hydraulic connections

### 3.13 Transferred medium

| Parameter                                       | Value     |
|---|-----------|
| Permissible medium viscosity [cSt] <sup>2</sup> | 150       |
| Ideally free of solids, max. particle size [µm] | < 70      |
| Permissible media temperature <sup>3</sup> [°C] | +5 to +80 |

#### WARNING



##### Poisoning and caustic burns

If corrosive, poisonous, ionising or biological media come into contact with skin, eyes and the respiratory tract they may cause serious injuries

- Observe the safety data sheets for the media to be transferred
- Use personal protective equipment
- Operate the pump in a suitably protected area
- Check the resistance of any parts which come into contact with the fluid (see chemical resistance list or consult your local KNF dealer)

#### WARNING



##### Damage caused by ionising radiation

Radioactive materials cause serious damage to health and reduce the service life of the pump.

- Decontaminate the pump
- Wear personal protective equipment
- Mark the pump

#### NOTE

If it cannot be ensured that the transferred medium is free of solids, a < 70 µm filter with a sufficiently large filter area must be fitted upstream of the pump to prevent it from being damaged (see Chapter 13).

#### NOTE

Before using a medium, check the compatibility of the materials of the pump head, pump housing, diaphragm and valves with the medium.

- Check resistance, see chemical resistance list and Section 4.3
- Clarify resistance with KNF

<sup>2</sup> Using the fluid type setting "Visc500cSt" allows media with a viscosity of 500 cSt to be transferred at a limited flow rate. (see Section 7.11)

<sup>3</sup> Applies to water and low-reactivity media. For aggressive media, resistance is to be checked at a higher medium temperature.

### 3.14 Accuracy/ reproducibility

The accuracy of the metering pump is appropriately characterised by the maximum absolute error A and the maximum relative error B:

→ max. inaccuracy  $\leq A + B$

| Error                             | Value                              |
|-----------------------------------|------------------------------------|
| Absolute error A                  | $\leq \pm 1\text{‰}$ nominal value |
| Relative error B                  | $\leq \pm 1.9\%$ of setting value  |
| Max. deviation                    | $\leq A+B$                         |
| Mean accuracy                     | +/- 2%                             |
| Mean reproducibility <sup>4</sup> | +/- 1%                             |

Tab. 14: Error A and error B

Example: SIMDOS 02, nominal value of 20ml/min

For a setting of 5ml/min, the accuracy should therefore be within the following error limits:

$$\begin{aligned} \text{Deviation} &\leq (\pm 1\text{‰} \times 20\text{ml/min}) + (\pm 1.9\% \times 5\text{ml/min}) \\ &\leq (\pm 0.02\text{ml/min}) + (\pm 0.095\text{ml/min}) \\ &\leq \pm 0.115\text{ml/min} \\ &\approx \pm 2\% \text{ of setting value} \end{aligned}$$



#### ⚠ CAUTION

##### Deviating metering accuracy

The metered volume may deviate from the set value due to gases, particles, or cavitation in the fluid system.

- Use a pre-filter, especially for media containing solid particles or fibers (see Chapter 13)
- Clean the valve disc/pump head (see Section 10.4)
- Ventilate the pump and system well
- Set the liquid type, for highly viscous and outgassing media, see Section 7.11



#### ⚠ CAUTION

##### Deviating metering accuracy

Transferring media containing particles larger than 70 µm may block the valves in the pump head.

- Use a pre-filter, especially for media containing solid particles or fibers (see Chapter 13)
- Monitor the metering
- Clean the valve disc/pump head (see Section 10.4)

<sup>4</sup> Under constant environmental conditions and with the same hose configuration

**NOTE**

Greater inaccuracies may occur for fluids with a viscosity of > 150 cSt or with a tendency to gassing out

- Set "fluid type" (see Section 7.11)
- Calibrate the pump in the system (see Section 7.12)

**NOTE**

The flow rate may differ from the calibrated value for some applications, according to the medium, its viscosity, density and temperature, pressure and installation type (e.g. cross-section constrictions)

- For accurate metering, calibrate the metering pump in the system (see Section 7.12)

## 4 Assembly and function

### 4.1 Metering pump structure

- 1 STOP button
- 2 START button
- 3 Display
- 4 Control knob
- 5 Inlet
- 6 Pump head
- 7 Outlet
- 8 Power supply connector
- 9 Remote Control connector (RC and RC Plus version only)
- 10 Connector for serial communication (RC Plus version only)

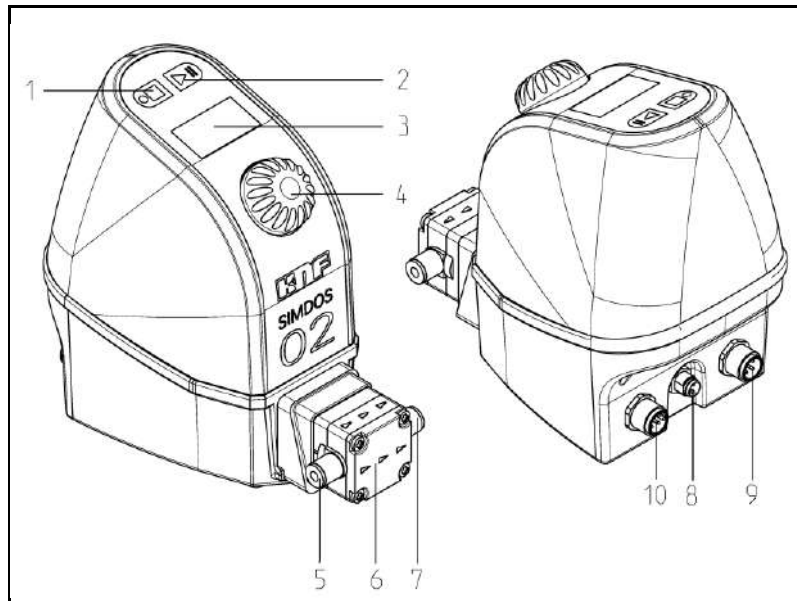

Fig. 3: Diaphragm pump

### 4.2 Operating principle

- 1 Outlet valve
- 2 Inlet valve
- 3 Working chamber
- 4 Diaphragm
- 5 Eccentric
- 6 Connecting rod
- 7 Pump drive

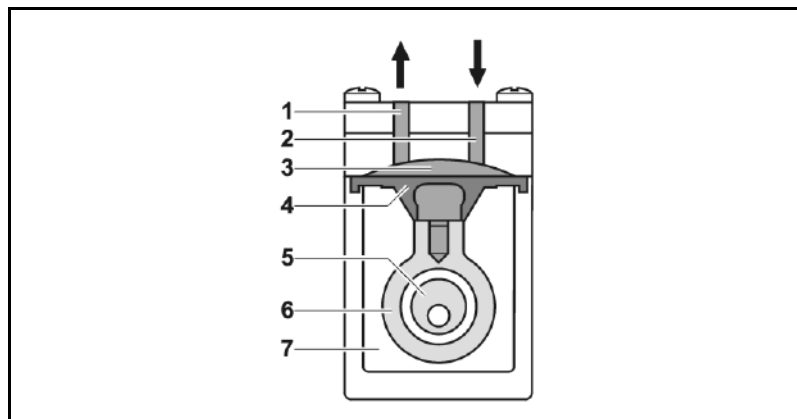

Fig. 4: Pump assembly

Principle: The diaphragm liquid pumps are based on reciprocating displacement pump technology. The elastic diaphragm (4) is moved up and down by the eccentric (5) and the connecting rod (6). In the downward stroke it aspirates the medium to be transferred via the inlet valve (2). In the upward stroke, the diaphragm pushes the medium out of the pump head via the outlet valve (1). The diaphragm hermetically seals off the working chamber (3) from the pump drive (7).



## Patented drive system

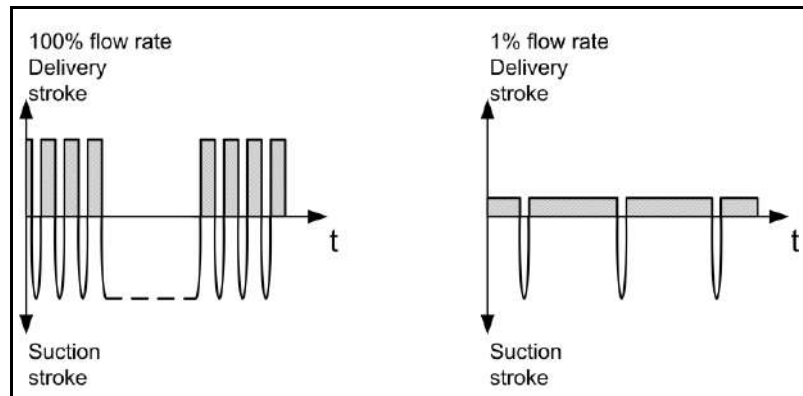

Fig. 5: Low-pulsation operating principle

SIMDOS® diaphragm metering pumps are fitted with a patented drive system. The suction stroke is always driven at maximum speed, but the exhaust process is varied according to the selected speed, ensuring maximum possible uniformity of discharge during the entire stroke (see Fig. 4). This results in a low-pulsation, quasi-continuous transfer process. This is the key difference between SIMDOS® metering pumps and diaphragm metering pumps with linear magnet diaphragm drive or with conventional eccentric diaphragm drive.

The characteristic curve for the suction and exhaust strokes can also be adapted to the medium by setting the appropriate fluid type (see Section 7.11).

### 4.3 Valves

The SIMDOS is supplied with DuPont™ Kalrez®<sup>5</sup> valve disks as standard, but can also be supplied with valve disks made of CHEMRAZ®<sup>6</sup> as an option.

#### ⚠ WARNING

##### Danger of leaks and inaccurate metering caused by non-resistant valve materials

Using the wrong valve materials will result in inaccurate metering and possibly the complete failure of the valve system

- Check the resistance of any parts which come into contact with the fluid (see chemical resistance list or consult your local KNF dealer, or contact [www.knflab.com](http://www.knflab.com))
- Avoid transferring media containing fluorine
- Regularly check that the pump is working properly and is not leaking, especially when transferring aggressive and corrosive media



<sup>5</sup> DuPont™ Kalrez® is a registered trademark of E.I. du Pont de Nemours and Company or one of its subsidiaries. All rights reserved.

<sup>6</sup> CHEMRAZ® is a registered trademark of Greene, Tweed & Co. All rights reserved.

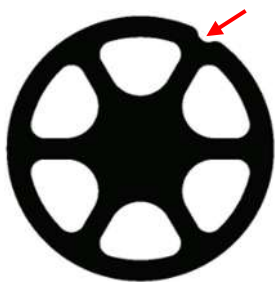

Fig. 6: Kalrez<sup>®</sup>, standard valve

### 4.3.1 Standard valve, DuPont™ Kalrez<sup>®</sup>

The SIMDOS is supplied with DuPont™ Kalrez<sup>®</sup> valve disks as standard. This material is resistant to most chemicals.

The optional CHEMRAZ<sup>®</sup> Valve Kit (see Section 13.1) is required for the liquids in Tab. 15.

- The resistance of the individual materials can be found in the chemical resistance list provided.
- In case of doubt, please contact your local KNF dealer.

### NOTE

The valve material can be identified from the geometry of the valve disk.

- DuPont™ Kalrez<sup>®</sup> has one groove in its outer contour (see Fig. 6)
- CHEMRAZ<sup>®</sup> has six grooves in its outer contour (see Fig. 7)
- If CHEMRAZ<sup>®</sup> valves are used, the pump is to be labelled accordingly
- The instructions in Section 10.4 are to be followed when removing the valves

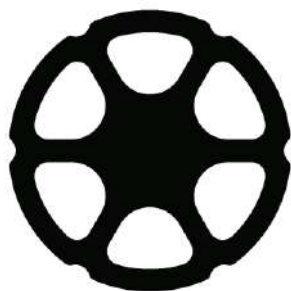

Fig. 7 Chemraz<sup>®</sup> valve, optional

### 4.3.2 CHEMRAZ<sup>®</sup> Valve Kit

Experience shows that CHEMRAZ<sup>®</sup> valves should be used for the following liquids:

| <b>Solvents</b>                 |   |
|---------------------------------|---|
| Tetrahydrofuran (THF)           | C <sub>4</sub> H <sub>8</sub> O               |
| Dimethyl sulfoxide (DMSO)       | C <sub>2</sub> H <sub>6</sub> OS              |
| Dimethyl formamide (DMF)        | C <sub>3</sub> H <sub>7</sub> NO              |
| Methyl ethyl ketone (MEK)       | C <sub>4</sub> H <sub>8</sub> O               |
| Cyclohexane                     | C <sub>6</sub> H <sub>12</sub>                |
| <b>Concentrated acids (75%)</b> |   |
| Hydrofluoric acid               | HF  |
| Nitric acid                     | HNO <sub>3</sub>                              |
| Sulphuryl dichloride            | SO <sub>2</sub> CL <sub>2</sub>               |
| Trifluoroacetic acid            | C <sub>2</sub> HF <sub>3</sub> O <sub>2</sub> |

Tab. 15: Excerpt from the chemical resistance list for the CHEMRAZ<sup>®</sup> Valve Kit

#### 4.4 Pump diaphragm

The pump diaphragm is covered with a layer of PTFE to ensure good chemical resistance. Type "FT" uses a pure FFKM diaphragm.

#### 4.5 Pump head

The pump head comprises an intermediate plate (1), a connecting plate (2) and a head plate (3). The intermediate and connecting plates come into contact with the liquid, so the resistance of the corresponding head materials must be established.

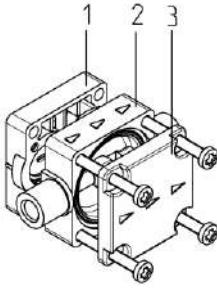

Fig. 8: Pump head

#### 4.6 Operating controls

- 1 STOP button**
  - Switch pump on/off
  - Stop transfer process
- 2 START button**
  - Start and interrupt transfer process
- 3 Display**
  - Display operating parameters
- 4 Control knob**
  - Set flow rate (turn)
  - Navigate through program (turn)
  - Confirm (press)

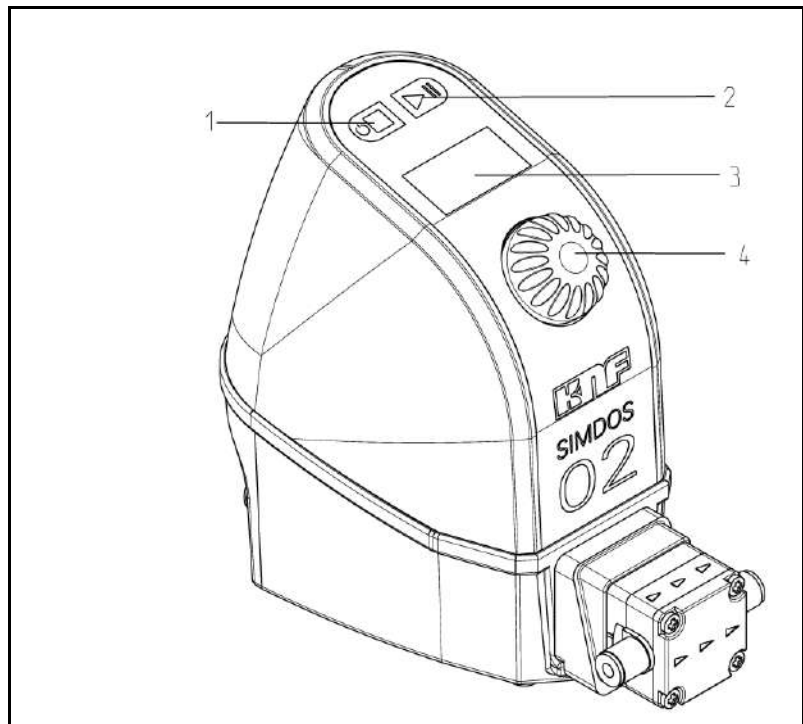

Fig. 9: Operating controls

### 4.6.1 Display

The main display shows the principal pump settings.

- 1 Specified flow
- 2 Cycle metering mode
- 3 Current cycle
- 4 Programmed cycles
- 5 Autostart
- 6 Remote control
- 7 Analog input
- 8 Digital input 1
- 9 Digital input 2
- 10 Operating mode display
- 11 Flow setting unit
- 12 Volumeter
- 13 Time counter

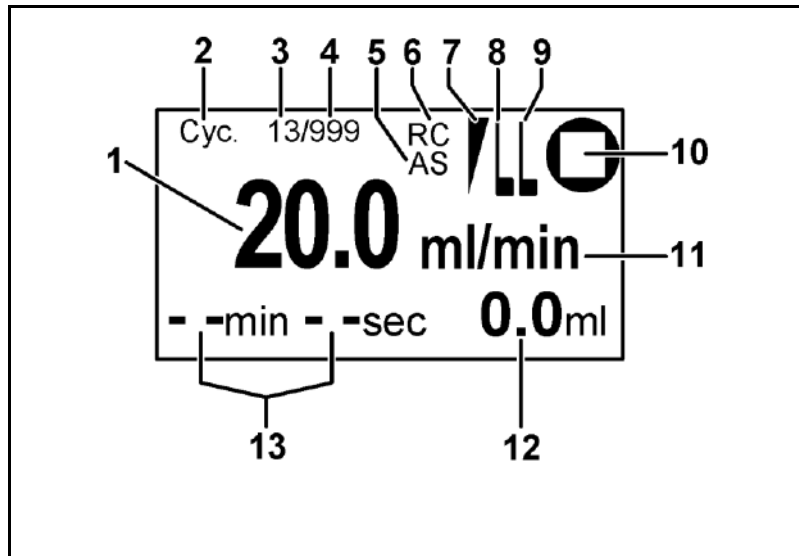

Fig. 10: Main display

|                         |   |
|-------------------------|---|
| Specified flow and unit | Displays the flow rate set (1) if the unit (11) has been set to "ml/min".<br>Displays the metering volume (1) if the unit (11) has been set to "ml".  |
| Time counter            | Displays the pump running time. <ul style="list-style-type: none"> <li>▪ Downward count (13) if a timeout (metering) has been programmed. Time remaining display.</li> </ul>  |
| Volumeter               | Display of delivery volume (12) since last pump start-up.   |
| Remote control          | Displays whether pump external drive has been activated, and the external drive condition (6, 7, 8, 9).   |
| Autostart               | Displays whether pump has been set to Autostart (5).  |
| Operating condition     | Displays whether the pump is operating, stopped or paused (10).   |
| Cycle metering mode     | If this display (2) is active, the programmed number of volumes (3) is metered. During operation the current cycle number (3) is incremented until the programmed cycle number (4) is reached. <ul style="list-style-type: none"> <li>▪ During metering, the transfer time remaining for the current dose is displayed.</li> <li>▪ During the pause the pump counts down the pause time remaining.</li> </ul> |

**4.6.2 Main menu**

| Display  | Function  |
|--|---|
| <div style="border: 1px solid black; padding: 5px; margin-bottom: 5px;"> <p style="text-align: center;"><b>20.0</b> ml/min<br/>-- min -- sec 0.0 ml</p> </div> | <p>Flow rate 0.03 – 20 ml/min<br/>Metering volume 0.03 – 1000 ml<br/>and metering time timeout</p>  |
| <div style="border: 1px solid black; padding: 5px; margin-bottom: 5px;"> <p style="text-align: center;"><b>Prime</b></p> </div>                                | <p>High-speed operation for priming or emptying</p>   |
| <div style="border: 1px solid black; padding: 5px; margin-bottom: 5px;"> <p style="text-align: center;"><b>Fluid type</b> S</p> </div>                         | <p>Set the pump for the characteristics of the medium to be transferred</p> <p>S = Standard: aqueous media<br/>D = Volatile: media with a low boiling point<br/>V = Visc100 cSt: media up to 100 cSt<br/>H = Visc500 cSt: media up to 500 cSt</p> |
| <div style="border: 1px solid black; padding: 5px; margin-bottom: 5px;"> <p style="text-align: center;"><b>Cal.</b> 100%</p> </div>                            | <p>To calibrate the pump</p>  |
| <div style="border: 1px solid black; padding: 5px; margin-bottom: 5px;"> <p style="text-align: center;"><b>Cycle</b> Off</p> </div>                            | <p>Set cycle metering mode (several volumes)<br/>Quantity: Repetitions (Off, 2...999, Inf)<br/>Pause: pause time (1s...99 min 59s)</p>  |
| <div style="border: 1px solid black; padding: 5px; margin-bottom: 5px;"> <p style="text-align: center;"><b>System</b> →</p> </div>                             | <p>Switch to system menu</p>  |

### 4.6.3 System menu

| Display       | Function  |
|---------------|---|
| Back ←        | Switch to main menu   |
| English       | select language   |
| A_in Aus      | Analog input of pump* <ul style="list-style-type: none"> <li>▪ Off</li> <li>▪ 0 – 5 V, 0-10 V, 0 – 20 mA, 4 – 20 mA</li> </ul>  |
| Range 100%    | Flow rate range selection for analog input* <ul style="list-style-type: none"> <li>▪ 100% 1 – 100% 0.20 – 20 ml/min</li> <li>▪ 30% 0.3 – 30% 0.06 – 6 ml/min</li> <li>▪ 15% 0.15-15% 0.03 – 3 ml/min</li> </ul> |
| In1 Off       | Digital input 1:* <ul style="list-style-type: none"> <li>▪ Off</li> <li>▪ Start/Stop using level or pulse signal</li> </ul>   |
| In2 Off       | Digital input 2:* <ul style="list-style-type: none"> <li>▪ Off</li> <li>▪ Reset or high-speed operation</li> </ul>  |
| Out Alarm     | Digital output:* <ul style="list-style-type: none"> <li>▪ Error/alarm</li> <li>▪ End of metering volume</li> <li>▪ Volume pulses</li> <li>▪ Motor running (level)</li> <li>▪ Motor pulses</li> </ul>            |
| Autostart Off | Set autostart <ul style="list-style-type: none"> <li>▪ Off</li> <li>▪ On (pump will start running as soon as mains voltage is applied)</li> </ul>   |
| Contrast 40   | Set display contrast  |
| Reset Nein    | Reset pump to factory settings  |
| Maintenanc.   | Maintenance position for diaphragm replacing  |
| Back ←        | Switch to main menu   |

**NOTE**

\* RC functions are available for RC and RC Plus pumps only (see Section 3.4). See Chapter 8 for further details of the external drive system.

Operating modes

Continuous transferring

In this case, the device transfers at a constant flow rate.

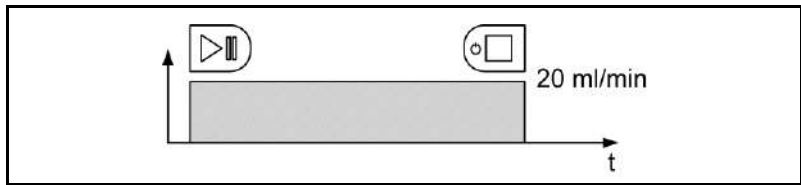

Fig. 11: Continuous transferring

Continuous transferring with timeout

In this case, the device transfers at a constant flow rate, then switches off after a specified time.

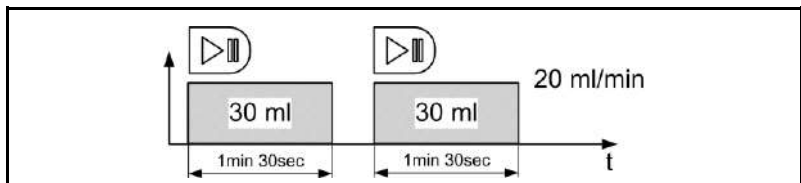

Fig. 12: Continuous transferring with timeout

Metered volume

Transferring of a specified volume in a specified time.

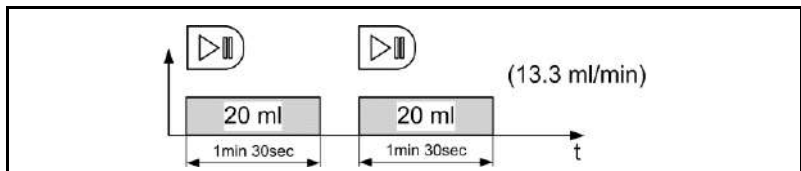

Fig. 13: Metered volume with timeout

Cycle metering mode  
metering several volumes

The pump meters n repetitions of a defined metering cycle with pause time.

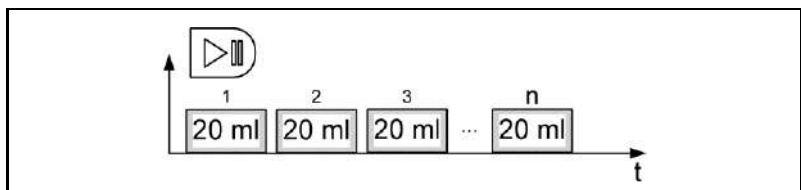

Fig. 14: Cycle metering mode

## 5 Shipment

### 5.1 Checking delivery

- Prior requirements
- Device delivered and packaged
- Procedure
1. Check delivery for visible damage
  2. Check that delivery is correct and complete using the packing list
  3. In the event of a discrepancy, register a complaint.
  4. Keep original packaging in case you have to return the item

### 5.2 Registering a complaint

- Prior requirements
- Device damaged or incomplete
- Procedure
1. If there are any visible signs of damage, only accept the delivery with reservations.
  2. Damage and complaints of any kind should be recorded on the delivery note
  3. Notify the manufacturer of any damage and complaints

### 5.3 Arranging for return

- Prior requirements
- Device damaged or incomplete
- Procedure
1. Contact KNF before returning the device
  2. Flush and decontaminate pump
  3. Fill out decontamination declaration and attach to the pump
  4. Send the pump in its original packaging to a service location or one of our product centres
  5. The pump can be sent by parcel service or post in its original packaging

## ⚠ DANGER

### **Danger of poisoning, chemical burns, or radioactive contamination through contact with pump parts that are not decontaminated**

Contact with pump parts that are not properly decontaminated will result in poisoning, chemical burns, or radioactive contamination.

- Use personal protective equipment
- Flush and decontaminate the pump until the possibility of danger can be eliminated.
- Label any pumps that are used with particularly dangerous media
- Only decontaminated pumps may be sent





| <b>NOTICE</b> |   |
|---------------|---|
|               | <p>KNF retains the right to refuse repair of pumps that are used to move hazardous materials.</p> <p>This applies particularly to the following materials:</p> <ul style="list-style-type: none"> <li>➤ Poisons</li> <li>➤ Radioactive media</li> <li>➤ Elementary halogens (e.g. bromine)</li> </ul> |

## 6 Installation and initial start-up

### 6.1 Safety



| <b>⚠ WARNING</b> |  |
|------------------|--|
|                  | <p><b>Danger as a result of incorrect installation</b></p> <p>Injuries or damage to equipment caused by escaping media</p> <ul style="list-style-type: none"> <li>➤ Follow installation instructions</li> <li>➤ After assembly, test the system with a harmless liquid</li> <li>➤ Only use pump if it is in perfect working order</li> </ul> |



| <b>⚠ WARNING</b> |   |
|------------------|---|
|                  | <p><b>Danger of serious injuries or property damage caused by escaping media in the event of rupturing of the pump diaphragm</b></p> <p>Poisoning and caustic burns caused by escaping media as a result of rupturing of the pump diaphragm. If the pump diaphragm ruptures, the medium is channelled out of the pump through the discharge outlet.</p> <ul style="list-style-type: none"> <li>➤ When transferring critical media, operate the pump in a collecting tank</li> <li>➤ Check discharge outlet for leaks</li> </ul> |



| <b>⚠ WARNING</b> |  |
|------------------|--|
|                  | <p><b>Danger of serious injuries or property damage caused by escaping media in the event of overpressure on the suction side</b></p> <p>Overpressure on the suction side will result in uncontrolled escaping of the fluid, even if the pump is not operating.</p> <ul style="list-style-type: none"> <li>➤ Avoid overpressure on the suction side</li> <li>➤ Fit a pressure control valve (see Section 6.3.3)</li> </ul> |

The following requirements apply to all the activities described in this chapter:

|                               |   |
|-------------------------------|---|
| Prior requirements            | <ul style="list-style-type: none"> <li>▪ Device is in perfect working order</li> <li>▪ The system is operated with water</li> </ul> |
| Personnel                     | <ul style="list-style-type: none"> <li>▪ Must be assembled by specialist personnel</li> </ul>                                       |
| Personal protective equipment | <ul style="list-style-type: none"> <li>▪ Not required</li> </ul>  |

## 6.2 Installation

Before installation, store the pump at the installation location to bring it up to ambient temperature.

### NOTE

For problem-free, safe operation the following instructions should be followed:

- Install in a dry place.
- Protect the installation location of the pump from water in the form of rain, spray, splashes and drips.
- Do not operate the pump in an aggressive or inflammable environment.
- Choose a safe location (a level, flat surface) for the pump.
- If the stability of the pump cannot be ensured, fasten the pump in place using two screws.
- Make sure that the hose connections can be fitted without strain on the hoses.
- Protect the pump against shocks, impacts and strong vibrations.

### 6.2.1 Connect mains plug

#### ⚠ DANGER

##### Risk of electric shock

- Only operate the pump with the power supply unit supplied
- Connect the cable from the mains plug to the pump's power supply socket
- Connect the mains plug into a correctly installed and properly earthed mains socket
- Ensure that the mains plug is protected from water splashes
- Do not open pump housing or power supply unit
- Disconnect pump from power supply during maintenance work
- If pump is installed permanently, fit a maintenance switch



When connecting the device to a power source, the relevant norms, directives, regulations and technical standards must be observed.

1. Use suitable adapters in the power supply unit
2. Connect power supply unit to pump

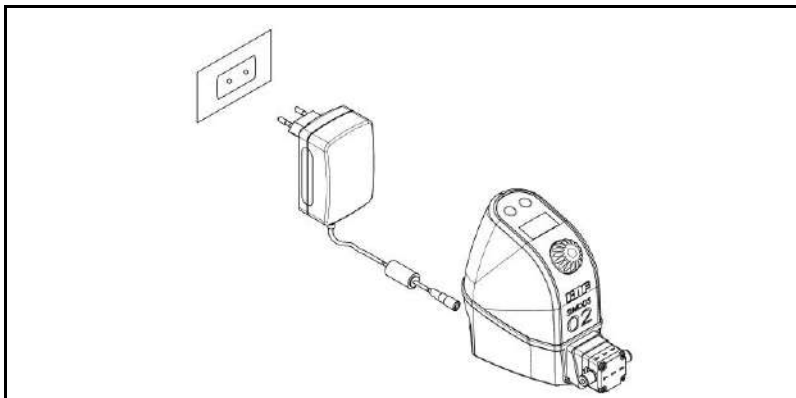

Fig. 15: Electrical connection

### 6.2.2 Connect filter



#### CAUTION

**Danger of excessive banking-up pressure (resistance) in the filter as a result of high particle concentration in the medium or a mesh size which is too small**

This reduces the flow rate and causes errors in metering accuracy

- Use filters with a sufficiently large mesh size
- Filter fluid beforehand where appropriate
- Check filter penetration regularly, cleaning or replacing the filter where necessary (see filter data sheet)



#### CAUTION

**Danger of blocked filters as a result of excessive particle concentration in the medium**

This reduces the flow rate and causes errors in metering accuracy

- Filter fluid beforehand where necessary
- Check filter penetration regularly, cleaning or replacing the filter where necessary (see filter data sheet)

Many media contain solids or fibres that are not visible to the naked eye. In order to maintain reliable pump operation, a filter is to be used on the suction side.

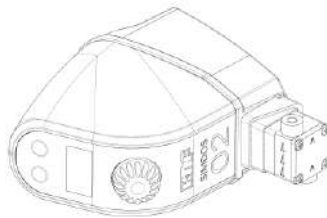

Fig. 16: Prime pump vertically

1. Connect the filters supplied on the suction side (for Order No. see Section 13.4)
2. Set up the system in the following steps
3. Rotate pump 90° anticlockwise
4. Prime pump so that the air can escape from the filter.
5. If there are no air bubbles in the system, the pump can be put into operation.

#### NOTE

Air in the pump head causes inaccurate metering.

1. Empty pump
2. Refill pump

**6.2.3 Connect hydraulics**

- |                                   |  |
|-----------------------------------|--|
| Connected components              | 1. Only connect components to the pump that are designed to handle the hydraulic characteristics of the pump (see Chapter 3).  |
| Hoses                             | 2. Only use hoses that are suitable for the maximum operating pressure of the pump (see Section 3.10).<br>3. Only use hoses that are sufficiently chemically resistant to the liquids being transferred. |
| Customer-specific pumps (PL, PML) | 4. The connections described below apply to standard products. Different connections may apply for customer-specific projects (PML or PL).   |

**NOTE**

Arrows on the pump head indicate the flow direction.

**FEM 1.02 – Screw-in connection fitting with internal thread**

- 1 Connector
- 2 Clamp ring
- 3 Hose connector
- 4 Hose

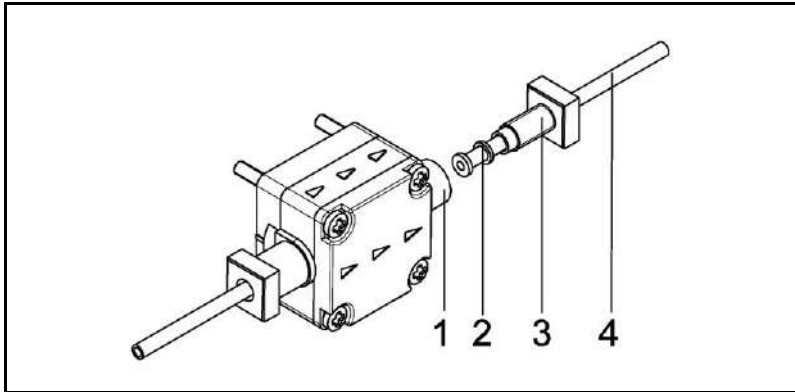

*Fig. 17: Hose connection UNF 1/4"-28*





1. Remove protective caps
2. Push clamp ring (2) onto flanged hose
3. Push hose connector (3) onto flanged hose
4. Screw hose connector (3) into connector (1)
5. **Hand-tighten** hose connector (3), tightening a little more if necessary
6. Connect the suction and pressure lines.  
(Recommendation: UNF 1/4"-28 flanged connection with 1/8" hose, see accessories list in Section 13.2)
7. Check that the hoses (1) and transition joints (hose connector/hose) are connected correctly and securely
8. Check that the system is leak-tight (see Section 10.5)

## 6.3 System setup

### 6.3.1 Recommended setup

In order to maintain reliable pump operation, the following setups should be considered.

Description of symbols for the following diagrams:

| Symbol  | Meaning | Symbol  | Meaning                             |
|---|---------|---|-------------------------------------|
|  | Pump    |  | Pressure control valve (adjustable) |
|  | Filter  |  | Storage container                   |

Tab. 16: Description of symbols

### 6.3.2 The storage container is level with the pump or underneath it

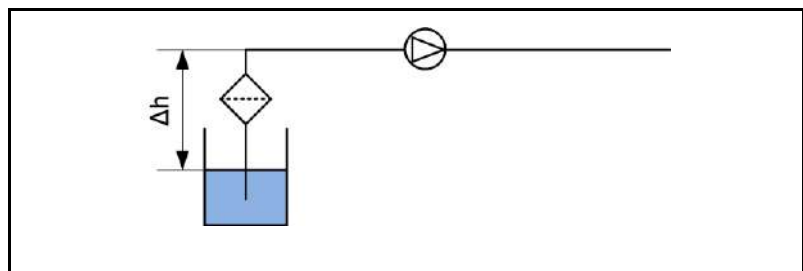

Fig. 18: Storage container underneath pump

In order to achieve the specified metering accuracy (see Section 10.5) the following instructions should be followed:

- Select suction head lower than  $\Delta h=1$  mWG
- Keep suction hose as short as possible
- Select a suction hose with a large cross-section
- Vent the pump
- For constant results, keep the level of liquid constant (use a container with a large base)

### 6.3.3 Storage container above the pump

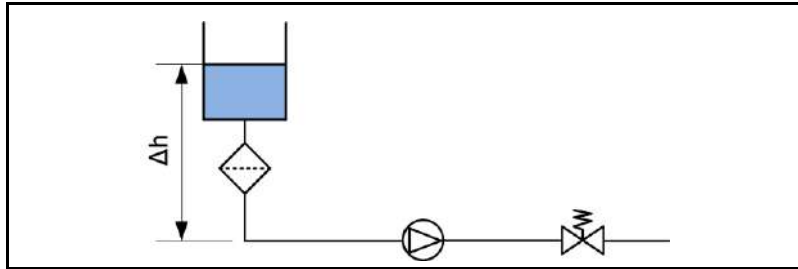

Fig. 19: Storage container above the pump.

## NOTE

### Overpressure on the suction side reduces the accuracy of the pump

In order to avoid uncontrolled escaping of the medium, a pressure control valve must be used on the pressure side (see Fig. 19).

- Set up the system as shown in Fig. 19
- Suitable pressure control valves are available as accessories (see Section 13.3)
- Set the pressure control valve to 0.5 bar. This allows a  $\Delta h$  of less than 4.5 m to be compensated for

### 6.3.4 Metering volatile media

For precise metering of liquids with a low vapour pressure, such as solvents, the system should be set up as shown in Fig. 20

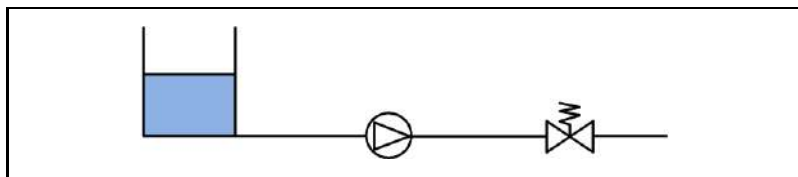

Fig. 20: Volatile media

1. Set up the system as shown in Fig. 20
2. The pressure control valve should be set to 0.5 bar
3. To avoid cavitation, set the fluid type "Volatile" or "Visc500cSt" (see Section 7.11)

### 6.3.5 Protection against overpressure

In order to protect the system against overpressure, a safety valve must be fitted immediately downstream of the pump (see Fig. 21).

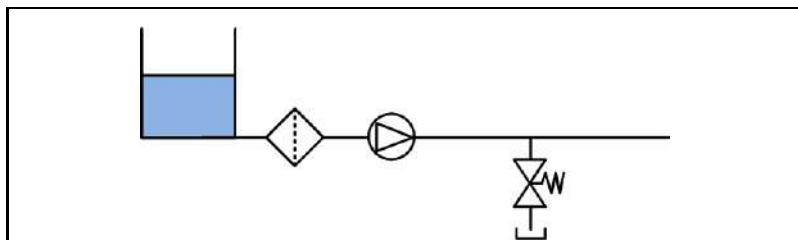

Fig. 21: Overpressure protection

## 6.4 Initial start-up

### ⚠ CAUTION



#### Danger of bursting of the fluid system as a consequence of overpressure

The pump builds up pressure. In a closed system the max. permitted operating pressure may be exceeded, thus causing damage to the pump and/or the system

- In the case of parts that are in contact with the fluid, only select those that are designed for the pump's operating pressure as a minimum
- Do not transfer against shut-off devices or closed systems, or
- install pressure relief/safety valves and set them to 6 bar (in the KNF product range)

### ⚠ CAUTION



#### Danger of unexpected chemical reactions with water

Water residues left in the pump from testing in the factory may react with the transferred medium.

- Before putting the pump into service, flush it with a non-critical medium

Before switching on the pump, check the following points:

#### Prerequisites for start-up

- All hoses attached properly
- Specifications of the power supply must correspond with the data on the pump and mains plug type plates.
- The pump outlet must be clear of any obstruction.
- All cables properly connected

Tab. 17: Prerequisites for start-up

1. Only operate the pump under the operating parameters and conditions described in Section 3.10.
2. Make sure the pump is used properly (see Section 2.1).
3. Avoid improper use of the pump (see Section 2.2).
4. Observe all safety precautions (see Chapter 2).

#### 6.4.1 Test the system

In order to prevent damage, the safety, leak-tightness and functioning of the test set-up should be checked using a suitable harmless medium, such as water.

## 7 Operation

### 7.1 Safety

#### DANGER

##### **Danger of injuries and property damage caused by hazardous materials**

Poisoning and caustic burns, or undesirable reactions caused by escaping hazardous materials



- Observe the safety data sheets for the media to be transferred
- Determine the resistance of the head materials
- Maintain the tightening torque of connections (see 6.2)
- Check tightening torque of head screws regularly (see Section 10.4)
- Check that pump and system are leak-tight
- Service pump regularly
- Only use pump if it is in perfect working order
- Operate pump in accordance with the technical data

#### WARNING

##### **Danger of undetected rupturing of diaphragm**

The diaphragm may be damaged by aggressive media, and the medium may escape from the discharge outlet



- Operate the pump in a collecting pan
- Flush pump thoroughly after use or if it is not to be used for an extended period (see Chapter 10.2)
- Check the discharge outlet regularly for leaks
- Observe the service lives of diaphragms and other elastomer parts (see Maintenance)

#### WARNING

##### **Danger of splashing media**

If corrosive, poisonous, ionising or biological media come into contact with skin, eyes and the respiratory tract they may cause serious injuries



- Observe the safety data sheets for the media to be transferred
- Check that the system is leak-tight before use
- Use personal protective equipment

#### CAUTION

##### **Danger of cavitation or particles in the fluid circuit**

Errors in metering accuracy



- Use a prefilter for media containing particulate matter
- Clean valve disk/pump head (see Section 10.4)
- Vent the pump and system thoroughly
- Set the type of liquid in the case of high-viscosity and volatile media (see Section 7.11)





**⚠ CAUTION**

**Incompatible media will cause valve parts to swell**  
 This swelling will cause errors in metering accuracy

- Check the resistance of any parts which come into contact with the fluid (see chemical resistance list or consult your local KNF dealer)

Prior requirements

Personnel

Personal protective equipment



Special tools required

- The following requirements apply to all the activities described in this chapter:
- Device is in perfect working order
  - The system has previously been operated and tested with a suitable harmless medium (e.g. water).
  - Trained personnel
  - The type of protective equipment required will depend on the medium to be transferred.
  - Observe safety data sheets and regulations for the handling of the media to be transferred.
  - At medium temperatures of over 50°C, take safety precautions against burns.
  - When transferring aggressive, biological, inflammable or ionising media, a suitable work station with a safety and extraction system is to be used.

## 7.2 Switching pump on / off

The default setting is for the pump to remain off when connected to the mains power supply.

### Switch on

1. Hold the “STOP” button down for at least **2 seconds**
  - ➔ the pump will now switch itself on
  - ➔ The display lights up, and the pump is ready for use.



Fig. 22: Switching on the pump

### Switch off

1. Hold the “STOP” button down for at least **2 seconds**.
  - ➔ The pump will now switch off completely.



Fig. 23: Switching off the pump

**NOTE**

When the pump is stopped, after ten minutes without any user input it switches into standby condition (display goes dark). However, the pump is still ready for use immediately when required.

- Press “STOP” or any other key to reactivate the pump from standby condition.
- The external drive reactivates the pump from standby as soon as a control signal is present.

### 7.3 Entering settings

- Turn the control knob to scroll the display up or down.

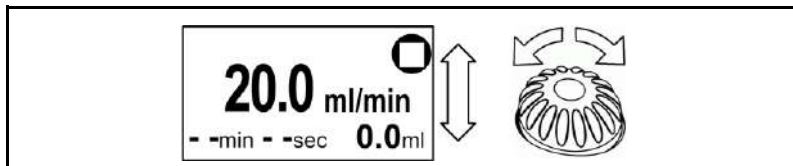

Fig. 24: Moving the operating menu up / down

- The lines in the middle of the display are enclosed in a frame, and can now be selected with the control knob.

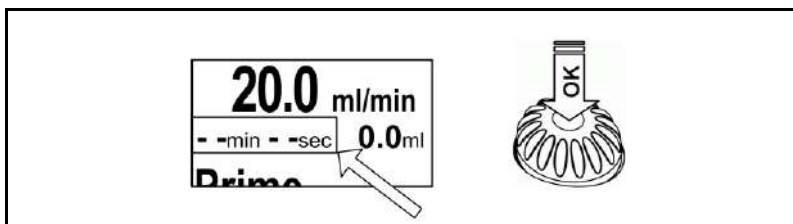

Fig. 25: Select the framed lines by pressing the control knob

- The selected settings are marked with an inverted display. Now turn the control knob to change the value as required.

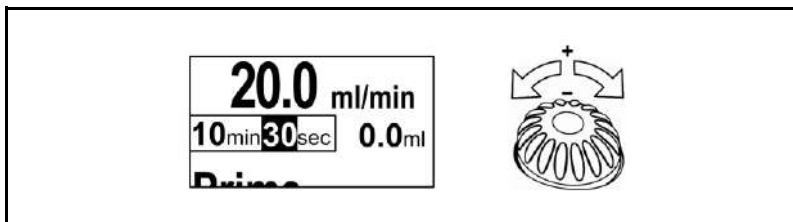

Fig. 26: Inverted display of editable values

- Press on the control knob to confirm your input, and move to the next value in the same line, if any.

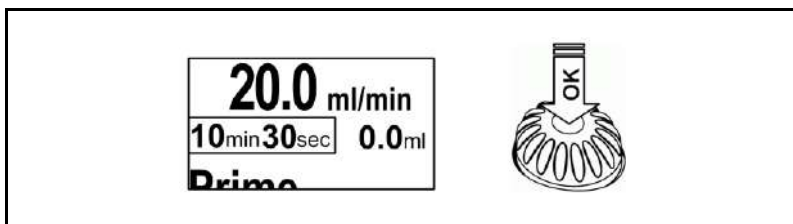

Fig. 27: Confirming the setting value by pressing the control knob

#### Ending the setting operation:

##### Method 1

1. Keep pressing the control knob until no values are selected (values marked with inverted display).
2. Turn the control knob until the main display can be seen at the top of the operating menu.
3. Press the "STOP" button:
  - ➔ The pump will stop when this operation is carried out. This ends the input operation, and the display switches back to the main display.

**Method 2**

1. Press the “START” button: this ends the input operation, and the display switches back to the main display.
  - ➔ The pump starts when this operation is carried out.

**7.4 Setting the operating mode**

1. Press control knob, Fig. 28 appears
  - ➔ The transfer value can be set by turning the control knob
2. Press the control knob to confirm the input
3. Turn control knob
4. Press control knob, Fig. 29 appears
  - ➔ The following operating modes can be set by turning the control knob.
    - [ml/min] for transferring at a fixed flow rate
    - [ml] for metering a volume
5. Press the control knob to confirm the input



Fig. 28: Specified flow



Fig. 29: Flow unit

| Input           | Unit                            | Setting range |
|-----------------|---------------------------------|---------------|
| Flow rate       | Millilitres per minute [ml/min] | 0.03 - 20.0   |
| Metering volume | Millilitres [ml]                | 0.03 - 1000.0 |

Tab. 18: Operating mode setting ranges

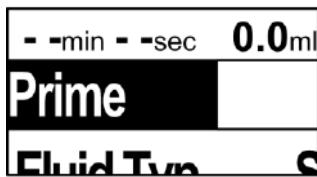

Fig. 30: Prime

### 7.5 Priming the pump

This function is for rapidly priming and emptying the pump head and hoses.

1. Press the control knob and hold in place for the duration of the priming / emptying operation.

→ The pump will run at a higher speed during this time.



#### IMPORTANT

The priming function interrupts any metering operation that is currently in progress.

#### NOTE

Air bubbles in the hose system prevent precise metering.

- Prime the system until no more bubbles are visible.
- Avoid bubble formation in the fluid
- Hold pump with filter in vertical direction of flow and prime (see Section 6.2.2)

### 7.6 Starting the pump

1. Press the "START" button.

→ The unit will begin transferring. The triangle symbol will appear in the display.

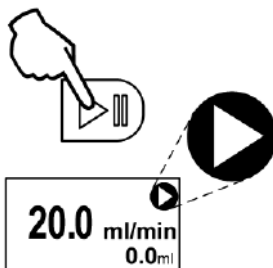

Fig. 31: Starting the pump

#### NOTE

An externally actuated pump will only start if the external control signals allow a pump start-up (see Chapter 8).

### 7.7 Interrupting a transferring operation

1. Press the "START" button

→ The transferring operation is interrupted. The pause symbol will appear in the display.

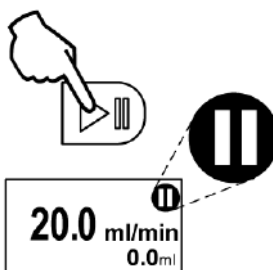

Fig. 32: Interrupting a transferring operation

#### NOTE

In "Pause" operating mode:

- when restarted, any interrupted transfer is continued.
- the pump responds to external control signals.

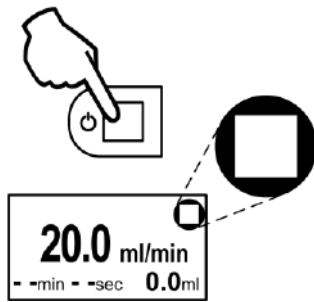

Fig. 33: Stopping the transferring operation

## 7.8 Stopping the transferring operation

1. Press the "STOP" button,
  - ➔ The transferring operation is interrupted. The pause symbol will appear in the display.
2. Press the "STOP" button again
  - ➔ The pump will now switch to "Stop" condition, and re-set the time counter and volumeter.

### NOTE

The first time the user presses the "STOP" button puts the working pump into Pause condition.

The pump goes into "Stop" condition only when the "STOP" button is pressed for the second time.

### Master Stop

Stopping the pump with the "STOP" button is called a "Master Stop".

### NOTE

Transferring after a Master Stop is only possible if:

- the Master Stop is manually cancelled using the "START" button;
- or if a "Reset" command is present at digital input 2.

### 7.9 Transferring fluid

1. Specify the required transfer value (see Section 7.4)
2. Set operating mode to [ml/min] (see Section 7.4)
3. Press the control knob to confirm the input
4. Press the "START" button
  - ➔ Pump transfers at the desired flow rate



Fig. 34: Time setting in seconds

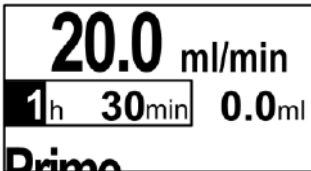

Fig. 35: Time setting in hours

**NOTE**

When operating:

- a timeout can be programmed.
  - ➔ The pump transfers at a set flow rate until the time has elapsed
- if a timeout is not specified (see Fig. 29),
  - ➔ the pump transfers at the set flow rate until stopped by a Pause or Stop command
- the time counter can be switched to hours and minutes. To do this, set the minute setting to more than 59 min

#### Timeout with time counter

The timeout function can be configured as follows.

| Input         | Meaning            | Setting range    |
|---------------|--------------------|------------------|
| -- min -- sec | Timeout not active | --               |
| mm min ss sec | Timeout active     | 1sec – 99h 59min |

Tab. 19 Timeout

### 7.10 Setting metering operation

1. Specify the required transfer value (see Section 7.4)
2. Set operating mode to [ml] (see Section 7.4)
3. Press the control knob to confirm the input
4. Press the "START" button
  - ➔ The pump transfers the desired volume

**NOTE**

**When metering a volume [ml]:**

- the permissible setting range for the time counter is restricted so that the flow rate will not exceed or fall below the permissible flow rate for the pump.
- the time counter cannot be deactivated. The setting [-- min -- sec] is not possible.

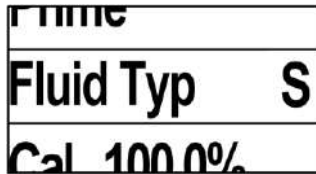

Fig. 36: Fluid type

## 7.11 Setting the fluid type

The "fluid type" setting is used to adjust the pump characteristic curve for different types of fluid.

1. Turn control knob until "Fluid Type" appears in the selection window
2. Press control knob

➔ The current setting is shown by character on the right-hand edge

The following settings are available for selection:

### Fluid type: Standard

Symbol: S

This is the optimum setting for all media with a viscosity similar to that of water. A uniform flow characteristic curve is obtained with short suction times and appropriate linearisation.



Fig. 37: "Standard" fluid type

### Fluid type: Volatile

Symbol: D

This is the appropriate setting for media with a low boiling point. As these media are sensitive to any pressure drop and deceleration phenomena:

- The pump suction rate is reduced
- The transferring characteristic curve reduces fluid acceleration and deceleration

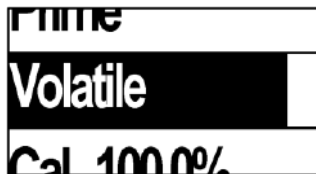

Fig. 38: "Volatile" fluid type

### Fluid type: Viscosity up to 100 cSt

Symbol: V

The setting "Visc100cSt" is for media with a viscosity of up to approx. 100 cSt. This setting alters the characteristics of the pump as follows:

- Suction rate is reduced
- Maximum flow rate is limited to 10 ml/min

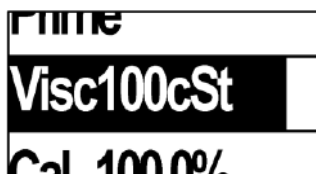

Fig. 39: "Visc100cSt" fluid type

### Fluid type: Viscosity up to 500 cSt

Symbol: H

This setting "Visc500 cSt" is for media with a viscosity of up to approx. 500 cSt. This setting alters the characteristics of the pump as follows:

- ➔ The pump suction rate is significantly reduced
- ➔ The maximum flow rate is limited to 4 ml/min



Fig. 40: "Visc500cSt" fluid type

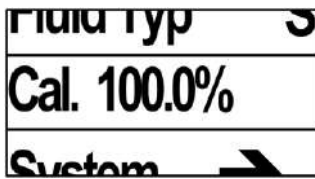

Fig. 41: Calibration



Fig. 42: Inputting the calibration actual value

## 7.12 To calibrate the pump

The pump has already been precisely adjusted in the factory. However, the device will operate even more precisely if it is calibrated. Calibration eliminates any variances caused by supply lines, back-pressure and viscosity.

Calibration can be used to adjust the pump flow rate by  $\pm 20\%$ .

1. Set up system
2. Take an accurate measurement of the flow rate or metering volume
3. Use the control knob to make the required menu selection [Cal. 100.0%]
4. Input the measured actual value with the control knob and confirm (see Fig. 42)
5. Check the calibration with a repeat measurement.

### NOTE

The calibration function uses the specified flow setting as the target value. This means the pump can always be calibrated for the current operating point.

### NOTE

If the target flow rate still cannot be achieved after several calibration attempts, see "Troubleshooting" (Chapter 12).



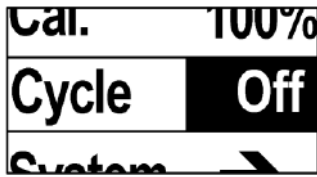

Fig. 43: Cycle display

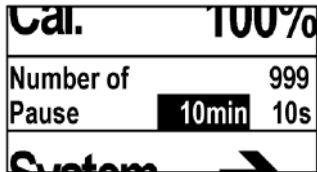

Fig. 44: Setting menu

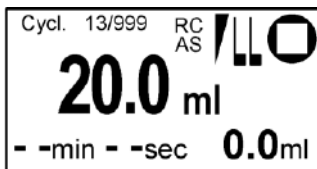

Fig. 45: Main display

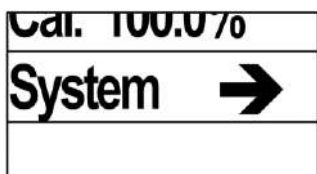

Fig. 46: System menu

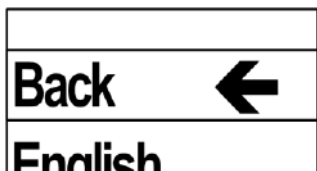

Fig. 47: Back to main menu

### 7.13 Cycle metering mode

The "Cycle" settings in the main menu allow several volumes to be metered with a specific pause time.

1. Use control knob to set desired volume
  - Set metering volume as volume in [ml].
  - Set metering volume as flow rate and time in [ml/min].
2. Select "Cycle" menu (see Fig. 43)
3. Press control knob
  - ➔ The display in Fig. 44 appears
4. Turn control knob
  - ➔ Specify number of cycles (Off, 2...999, unlimited)
5. Press control knob
6. Specify pause time
  - ➔ The following intervals are possible: 1s...99min 59s
7. Press control knob
  - ➔ Main display appears (see Fig. 45)

**NOTE**

If the pump is disconnected from the mains or switched off, cycle operation is deactivated for safety reasons.

**NOTE**

The "PAUSE" button can be used to temporarily interrupt the process. The process can be restarted by pressing the "PAUSE" button again.

### 7.14 Setting the system

Select "System" to call up a second menu allowing the other pump settings to be entered.

### 7.15 Back to main menu

Click on "Back" to return to the main menu for entering pump default settings.

Other options for returning to the main display are as follows:

- Press the "STOP" button: this ends the input operation, and the display switches back to the main display
  - ➔ The pump will stop when this operation is carried out
- Press the "START" button: this ends the input operation, and the display switches back to the main display
  - ➔ The pump starts when this operation is carried out
- Wait for 10 seconds without entering any inputs
  - ➔ The pump ends the input operation and switches back to the main display



Fig. 48: Language selection

### 7.16 Select language setting

The language setting operation selects the required language for the operating menu.

### 7.17 Activate autostart

#### ⚠ WARNING

##### Automatic start-up when autostart function is activated

The pump starts up by itself and without warning.

- Do not switch on the autostart function until the system has been tested and is ready for operation
- Clearly identify the fact that the autostart option for the pump has been activated
- Before start-up, check that hoses and equipment are leak-tight and correctly connected
- Do not operate the pump with hazardous media



Autostart and external drive

If you want the pump to respond automatically to external signals as soon as the power supply is switched on, you can activate the autostart option.

The “Autostart” setting defines the process for switching on the pump.

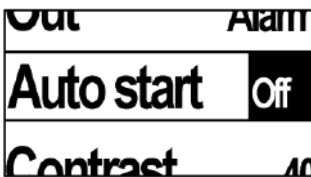

Fig. 49: Autostart

| Input | Meaning   |
|-------|---|
| Off   | Pump does not start by itself   |
| On    | Pump starts automatically when the power supply to the pump is switched on. |

Tab. 20: Autostart



Fig. 50: Autostart symbol in display

When the “Autostart” option is on, this is indicated in the main display with the “AS” symbol (see Fig. Fig. 50).

### 7.18 Set contrast

Display contrast adjustment. Adjust the contrast if the display is difficult to read.



Fig. 51: Contrast

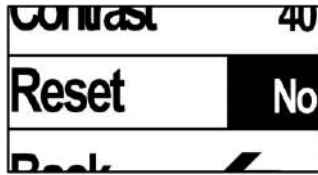

Fig. 52: Reset

### 7.19 Resetting the pump (Reset)

The "Reset" function is used to reset the pump to its factory settings.

| Input | Meaning                               |
|-------|---------------------------------------|
| No    | No reset takes place                  |
| Yes   | Pump is reset to its factory settings |
| Code  | No function                           |

Tab. 21: Reset

The reset function will restore the following settings:

| Value              | Setting = factory setting |
|--------------------|---------------------------|
| Flow rate [ml/min] | 10.0                      |
| Unit               | ml/min                    |
| Time counter       | Off --min -- sec          |
| Fluid type         | Standard                  |
| Calibration        | 100%                      |
| Language           | English                   |
| Analog input       | Off                       |
| Digital input 1    | Off                       |
| Digital input 2    | Off                       |
| Digital output     | Alarm                     |
| Autostart          | Off                       |
| Contrast           | 40                        |

Tab. 22: Reset factory settings

### 7.20 Shutting down the pump in an emergency

In order to shut the pump down in an emergency, pull out the mains plug. Or shut the pump down using the "Stop" button

## 8 RC version (remote control)

### ⚠ WARNING

#### Danger of automatic start-up

The pump starts up by itself and without warning.

- Do not switch on the autostart function until the system has been tested and is ready for operation
- Clearly identify the fact that the autostart option for the pump has been activated
- Before start-up, check that hoses and equipment are leak-tight and working properly
- Do not operate the pump with hazardous media



These remote control functions are only available in the RC and RC Plus version.

RC cable

1. Connect cable for remote control (RC cable) to a suitable signal source.

1. Remove protective caps from RC connector plug.

2. Connect RC cable to pump.

#### 1 Analog input

- Brown

#### 2 Digital input 1

- White

#### 3 Digital input 2

- Blue

#### 4 Open collector output

- Black

#### 5 Ground

- Grey

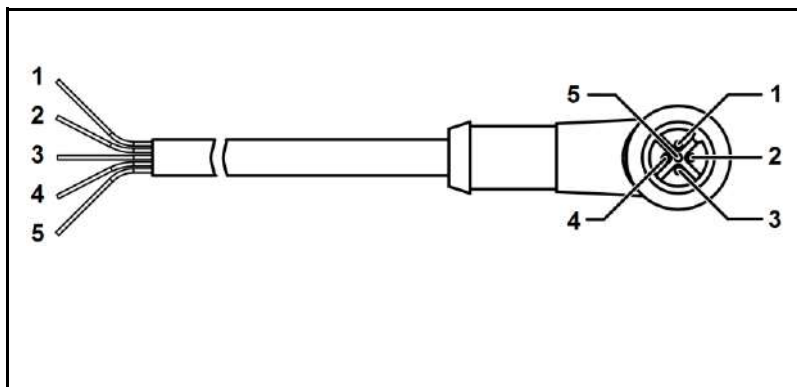

Fig. 53: KNF Flodos RC cable pin assignment

| Pin | Wire colour | Description     | Function   | max. value                                   |
|-----|-------------|-----------------|--|--|
| 1   | brown       | Analog input    | 0.15% to 100% up to flow rate, depending on settings | 10 V DC                                      |
| 2   | white       | Digital input 1 | Start / stop   | 24 V DC                                      |
| 3   | blue        | Digital input 2 | Reset / Prime / Foot Switch                          | 24 V DC                                      |
| 4   | black       | Digital output  | Various output signals                               | open collector<br>max. 10 mA<br>max. 24 V DC |
| 5   | grey        | Ground          | --   |  |

Tab. 23: RC cable pins

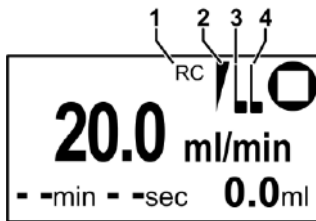

Fig. 54: RC main display

Activate analog input

When external drive is activated, this is indicated in the main display by the "RC" symbol (1) (see Fig. Fig. 54).

According to the inputs activated, the display also shows symbols for analog input (2), digital input 1 (3) and digital input 2 (4).

### 8.1 Remote control analog input

The analog input can be used to externally specify a pump flow rate (see Tab. 26).

The analog input can only be activated in transfer operation [ml/min].

| NOTE  |
|---|
| <p>When analog input is active:</p> <ul style="list-style-type: none"> <li>➤ the pump can be started only if a valid analog signal is present</li> <li>➤ the time counter is deactivated</li> <li>➤ manual inputting of flow metering volume is disabled</li> </ul> |

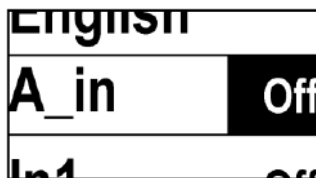

Fig. 55: Analog input

#### Control signals

| Input                | Meaning                 | Signal    |
|----------------------|-------------------------|-----------|
| Off                  | Analog input not active | - -       |
| 0-5 V                | Voltage control [V]     | 0.05 - 5  |
| 0-10 V               | Voltage control [V]     | 0.1 - 10  |
| 4-20 mA <sup>7</sup> | Current control [mA]    | 4.16 - 20 |
| 0-20 mA              | Current control [mA]    | 0.2 - 20  |

Tab. 24: Analog input options

#### On/off thresholds

In order to obtain clear switching criteria, a switching hysteresis is implemented.

| Input     | On threshold | Off threshold |
|-----------|--------------|---------------|
| 0 – 5 V   | 0.05 V       | 0.04 V        |
| 0 – 10 V  | 0.1 V        | 0.09 V        |
| 4 – 20 mA | 4.16 mA      | 4.08 mA       |
| 0 – 20 mA | 0.2 mA       | 0.18 mA       |

Tab. 25: On/off thresholds

<sup>7</sup> If the input is less than 2 mA, the pump will go into alarm mode, and the alarm is automatically reset as soon as the input exceeds 2 mA.

**Flow rate range selection for analog input**

There are three flow rate ranges for different set points (see Tab. 26).



Fig. 56: Flow rate range selection

|         |           |                 |
|---------|-----------|-----------------|
| ▪ 100%: | 1 – 100%  | 0.2– 20 ml/min  |
| ▪ 30%:  | 0.3 – 30% | 0.06 – 6 ml/min |
| ▪ 15%:  | 0.15-15%  | 0.03 – 3 ml/min |

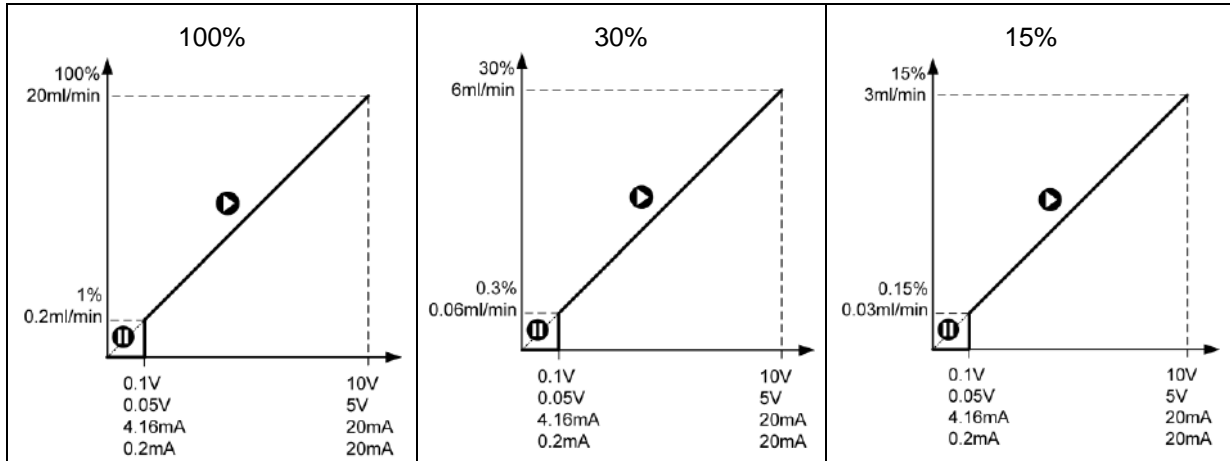

Tab. 26: Analog Input

START / STOP analog signal

**Starting and stopping the pump with an analog signal**

1. Set analog input to correct signal type
2. Press the "START" button.
  - ➔ Pump switches to "Pause" condition.
3. Apply analog signal.
  - ➔ The pump now starts operating, and switches to "Run" condition.
4. Reduce analog signal to below cut-off threshold.
  - ➔ Pump stops and switches to "Pause" condition.

**NOTE**

After the pump has been stopped, there is a pause time of 0.2 seconds before it can be restarted.

Master Stop

Stopping the pump with the "STOP" button is called a "Master Stop". The pump can then only be restarted manually (see Section 7.6).

**NOTE**

The pump is supplied with Master Stop. For initial start-up with external drive, it is therefore essential to press "START" once to cancel Master Stop.

For an external restart after a power cut, use autostart (see Section 7.17) or Reset on digital input 2 (see Section 8.3).

### 8.2 Digital input 1, Start / Stop

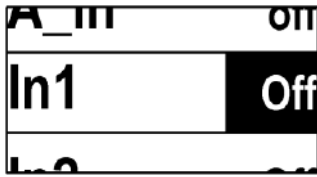

Fig. 57: Digital input 1

The pump can be started and stopped externally via digital input 1.

- If digital input 1 is active, the pump can only be started via the digital input.
- If analog actuation is also used, a valid analog signal must be present.

#### Control signals

| Input | Meaning                                | Signal                      |
|-------|--|-----------------------------|
| Off   | Digital input 1 not active             | - -                         |
| Level | Start / Stop according to signal level | < 0.8V = On<br>> 2.0V = Off |
| Pulse | Start / Stop on signal pulse           | < 0.8V = On<br>> 2.0V = Off |

Tab. 27: Digital input 1 options

**NOTE**

To ensure that the digital input operates correctly:

- after the pump has been stopped, there must be a pause time of 0.2 seconds
- select a pulse duration of more than 0.1 seconds
- use debounced switches

#### START / STOP in "Pump ml/min without timeout" condition

Start / Stop level

1. Set digital input 1 "In\_1" to Level.
2. Press the "START" button.
  - ➔ Pump switches to "Pause" condition.
3. Apply signal 1.
  - ➔ The pump will start to operate if the level is below 0.8 V, and stop if it is above 2.0 V (see Fehler! Verweisquelle konnte nicht gefunden werden.).

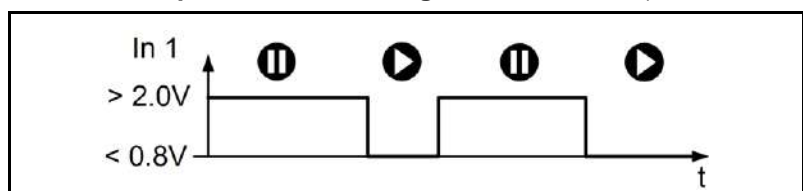

Fig. 58: Start / Stop level actuation

- Start / Stop pulse
1. Set digital input 1 "In\_1" to Pulse
  2. Press the "START" button.
    - ➔ Pump switches to "Pause" condition.
  3. Apply signal 1.
    - ➔ The pump will start to operate when a pulse of less than 0.8V is generated, and stop on the next pulse of more than 2.0V.

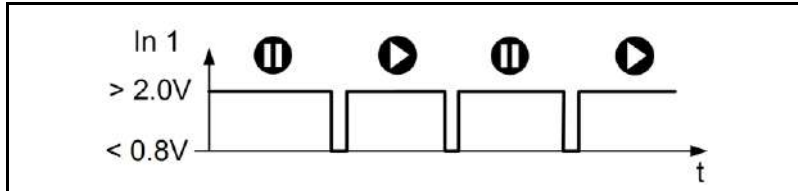

Fig. 59: Start / Stop pulse actuation

- Start / Stop level with timeout
- Start / Stop level with timeout**
1. Set digital input 1 "In\_1" to Level.
  2. Press the "START" button.
    - ➔ Pump switches to "Pause" condition.
  3. Apply signal 1.
    - ➔ The pump will start to operate when the level is connected to ground, and stop when the level rises above 2.0 V.

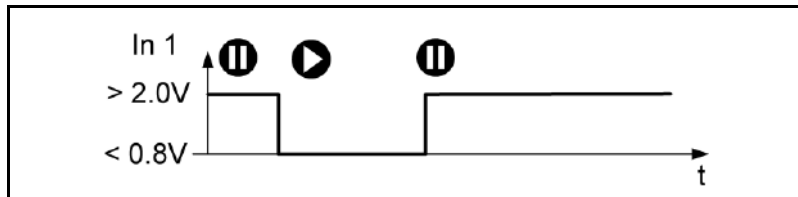

Fig. 60: Start ml/min with time counter level control

**NOTE**

- If timeout / time counter is activated
- to stop the pump, use digital input 2, "Reset" (see Section 88.3)
  - For precise dosing use pulse-mode



Start / Stop pulse with timeout

1. Set digital input 1 "In\_1" to Pulse
2. Press the "START" button
  - ➔ Pump switches to "Pause" condition.
3. Apply signal 1
  - ➔ The pump will start to operate when a pulse to ground is generated, and stop when the set time has elapsed.



Fig. 61: Start ml/min with time counter pulse control

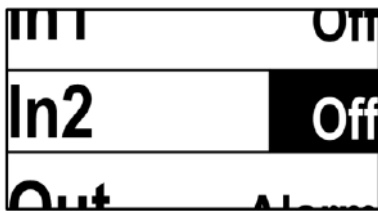

Fig. 62: Digital input 2

### 8.3 Digital input 2 Reset / Prime / Foot Switch

Digital input 2 can be used for an externally activated error "Reset" or fluid system "Priming" operation.

The level and pulse settings are the same as for digital input 1.

Digital input 2 is mainly used with a foot switch (see Section 13.5).

#### Control signals

| Input    | Meaning  | Signal  |
|----------|--|---|
| Off      | Digital input 2 not active   | --  |
| Reset    | Reset of pump errors and cancel metering with time counter             | $< 0.8V = \text{Reset}$   |
| Priming  | Rapid priming of pump head and hoses (see Section 7.12)                | $< 0.8V = \text{Prime}$   |
| Combined | Reset of pump errors and cancel metering with time counter, then prime | $< 0.8V$ reset for falling signal edge<br>Prime after 1 second $< 0.8V$ |
| Level    | Start / Stop according to signal level                                 | $< 0.8V = \text{On}$<br>$> 2.0V = \text{Off}$                           |
| Pulse    | Start / Stop on signal pulse   | $< 0.8V = \text{On}$<br>$> 2.0V = \text{Off}$                           |

Tab. 28: Digital input 2 options

**Reset Digital input 2 Reset**

The “Reset” setting activates the following functions on application of a signal to digital input 2:

- Interrupt a metering process
- Reset pump errors
- Cancellation of an active Master Stop, pump is now in “Pause” operation condition, and responds to external control signals.

**Priming Digital input 2 Prime**

The “Prime” setting activates the following functions on application of a signal to digital input 2:

- Interrupt a metering process
- Reset pump errors
- Pump runs in high-speed “Prime” mode for the duration of the signal
- Cancellation of an active Master Stop, pump is now in “Pause” operation condition, and responds to external control signals.

**Combined Digital input 2 Combined**

The “Combined” setting activates the following functions on application of a signal to digital input 2:

- Interrupt a metering process
- Reset of pump errors on signal edge
- If the signal is applied for longer than 1 second, the pump will operate in “Prime” at high speed for the duration of the signal
- Cancellation of an active Master Stop, pump is now in “Pause” operation condition, and responds to external control signals.

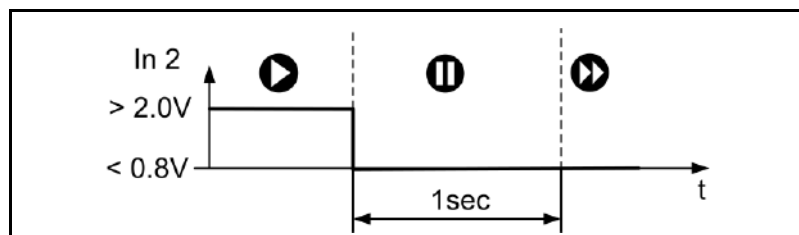

Fig. 63: Combined function sequence

**Start / Stop level START / STOP with foot switch using level**

1. Set digital input 2 "In\_2" to Level.
2. Connect foot switch to pump.
3. Press “START” – the pump goes into “Pause” condition.
  - ➔ The pump will keep operating as long as the foot switch is pressed.

**NOTE**

If time counter is switched on, pump will perform a complete metering cycle.

Start / Stop pulse

**START / STOP with foot switch using pulse**

1. Set digital input 2 "In\_2" to Level.
2. Connect foot switch to pump.
3. Press "START" – the pump goes into "Pause" condition.
  - ➔ Each time the foot switch is pressed the pump is started or stopped.

**NOTE**

If timeout / time counter is switched on, pump will perform a complete metering cycle.



Fig. 64: Digital output

**8.4 Digital output**

The digital output can be used to feed back a number of messages to the control system.

The output is an open collector output (see Section 3.8).

**Output signals**

| Set output function to: | Meaning                                    | Signal   |
|-------------------------|--|----------|
| Alarm                   | Pump error signal                          | Level    |
| Motor                   | Signal when pump motor running             | Level    |
| Vol.End                 | Signal when volume metering ends           | Level    |
| Mot.Pul.                | 10 pulses per revolution of the pump motor | Pulse *1 |
| Vol.Pul.                | One pulse per 20 µl of fluid transferred   | Pulse *1 |

Tab. 29: Digital output options

\*1 To capture pulse signals like Mot. Pul. And Vol. Pul. with a (1 ms) duration, a sampling rate > 2 kHz or a counter input with edge detection is necessary.

## 9 RC Plus version (serial communication)

### ⚠ WARNING



#### Danger of automatic start-up

The pump starts up by itself and without warning.

- Do not transmit a start command until the system has been tested and is ready for operation
- Mark remote-controlled pumps
- Before start-up, check that hoses and equipment are leak-tight and working properly
- Do not operate the pump with hazardous media

The functions for remote control via the RS 232 interface are only available with the RC Plus version.

RC cable

1. Connect cable for remote control (RC cable) to a suitable signal source.
2. Remove protective caps from RC connector plug.
3. Connect the RC cable to the pump.
4. The commands and protocol are available on [www.knf.com/downloads](http://www.knf.com/downloads) (search: "communication protocol")

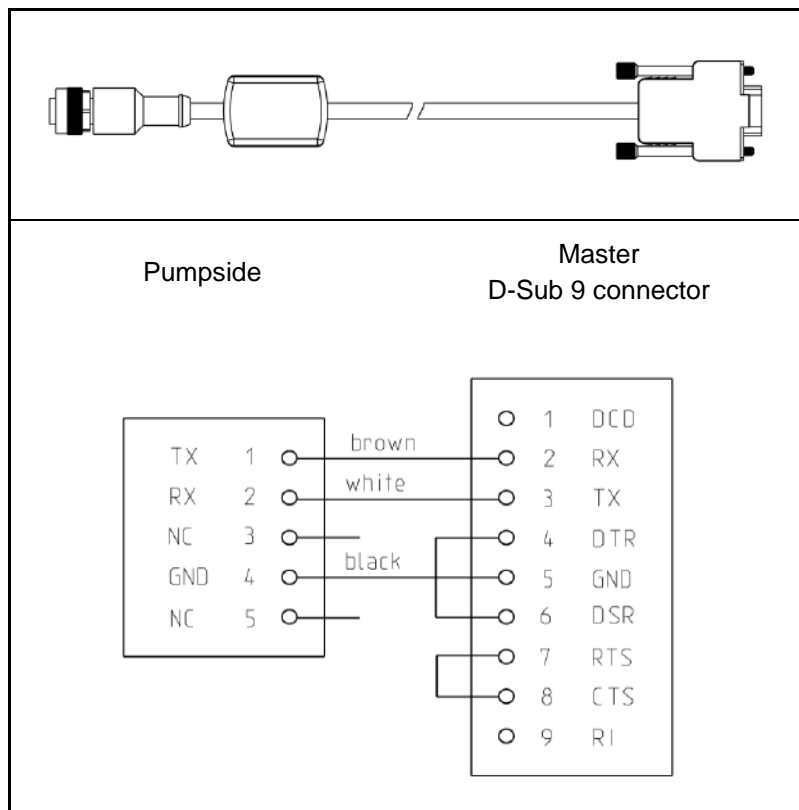

Fig. 65: KNF Flodos RC cable pin assignment

## 10 Cleaning and maintenance

### 10.1 Safety

#### DANGER



##### **Danger of injuries caused by hazardous materials**

Poisoning and caustic burns caused by contact with aggressive, inflammable or radioactive media

- Flush the pump thoroughly (see Chapter 10.2)
- Decontaminate the pump if necessary
- Observe the safety data sheets for the media to be transferred
- Wear suitable protective equipment

#### WARNING



##### **Gefahr vor Wärmeentwicklung durch chemische Reaktionen mit der Spülflüssigkeit**

Starke Wärmeentwicklung schädigt die Membrane, O-Ringe und das Ventilsystem, dies führt zu Leckagen

- Chemische Reaktionen in der Pumpe vermeiden
- Sicherheitsdatenblätter der geförderten Flüssigkeit beachten
- Nachfolgende Ratschläge beachten

The following requirements apply to all the activities described in this chapter:

- |  |   |
|--|---|
| Prior requirements<br>Personnel<br>Personal protective equipment | <ul style="list-style-type: none"> <li>▪ System depressurised</li> <li>▪ Specialist personnel</li> <li>▪ The type of protective equipment required will depend on the medium to be transferred.</li> <li>▪ Observe the safety data sheets for the media to be transferred.</li> </ul> |
|--|---|

## 10.2 Cleaning the pump

In order to maintain the service life of the pump, after each use and before any long periods of inactivity the pump must be flushed through with neutral media.

### **IMPORTANT:**

To ensure satisfactory start-up when the unit is again required, it is important to ensure that the pump is free of any crystallising, adhesive or curing media.

#### **10.2.1 Metering medium: acids**

- Flush pump with a suitable neutralising liquid in a circular flow for 10 minutes
- Then flush with distilled water for 5 minutes

#### **10.2.2 Metering medium: bases**

- Flush pump with a suitable neutralising liquid in a circular flow for 10 minutes
- Then flush with distilled water for 5 minutes

#### **10.2.3 Metering medium: organic solvents**

- Flush pump with isopropyl alcohol (C<sub>3</sub>H<sub>8</sub>O) in a circular flow for 10 minutes

### **NOTE**

Never flush non-polar solvents immediately with water

#### **10.2.4 Metering medium: biological solution**

- Flush pump with 10% hydrogen peroxide in a circular flow for 10 minutes
- Then flush with distilled water for 10 minutes

### **NOTE**

The procedure described in Section 10.2.4 is not a sterilisation

### 10.3 Maintenance plan

| Interval                          | Assembly                        | Action   | Personnel            |
|-----------------------------------|---------------------------------|--|----------------------|
| When changing the transfer medium | Complete pump                   | 5. Flushing the pump   | Specialist personnel |
| Daily                             | Complete pump                   | 6. Visually inspect the pump for pollution/contamination.<br>7. If pollution/contamination is found, clean the pump.<br>8. Check the discharge outlet on the intermediate flange for leaks | Trained personnel    |
|                                   | Complete pump                   | 9. Visually inspect the pump for external damage.<br>10. If damage is found, take corrective action (see Chapter "Troubleshooting")  | Trained personnel    |
|                                   | Complete pump                   | 11. Visually inspect the pump for leaks<br>12. If leaks are found the pump must under no circumstances be used. (see "Troubleshooting")  | Specialist personnel |
|                                   | Complete pump                   | 13. Check pump capacity<br>14. If pump capacity falls, clean the pump head and replace elastomer parts where necessary.  | Specialist personnel |
| Weekly                            | Filter (accessory)              | 15. Check filter for contamination.<br>16. If contamination is found, clean or replace the filter  | Specialist personnel |
| 1,000 hours of operation          | Pump diaphragm, valves and seal | 17. Replace pump diaphragm, valves and seal  | Specialist personnel |
| as required                       | Pump head                       | 18. Replace pump head  | Specialist personnel |

Tab. 30: Servicing schedule

### 10.4 Cleaning / replacing valve plates and pump diaphragm

**⚠ DANGER**



**Danger from hazardous materials**  
 Poisoning and caustic burns or undesirable reactions caused by escaping hazardous materials as a result of incorrect maintenance/servicing or the transferring of incompatible media.

- Follow the maintenance instructions
- Ensure cleanliness during maintenance (particles on seal faces cause leaks)
- Check that pump and system are leak-tight after maintenance

**⚠ WARNING**



**Danger of poisoning and caustic burns**  
 If they come into contact with skin and eyes, aggressive media cause poisoning and caustic burns.

- Flush pump as described in Section 10.2, Cleaning the pump.
- Wear protective equipment, e.g. protective gloves, safety glasses.

Prior requirements

- Pump switched off and disconnected from mains
- The pump must be free of any hazardous substances
- Hoses must be disconnected from the pump head
- Specialist personnel
- The type of protective equipment required will depend on the medium to be transferred.
- Observe the safety data sheets for the media to be transferred.

Personnel

Personal protective equipment

Tools and materials

| Qty | Tools/materials                                |
|-----|--|
| 1   | Phillips screwdriver no. 1                     |
| 1   | Spare parts kit (see Section 13.1)             |
| 1   | Torque screwdriver that can be set to 0.55 Nm. |

*Tab. 31: Tools/materials*

Information on procedure

Always replace valve disks, valve seats and seals at the same time, to maintain satisfactory flow rate performance.



**10.4.1 Cleaning the pump head**

**NOTE**

The pump head should only be cleaned if:

- the pump is no longer sucking properly,
- the flow rate is too low,
- reverse suction can be seen, or
- the pump head cannot be cleaned satisfactorily by flushing.

Ensure cleanliness when replacing valves, as pollution/contamination may prevent the valve from working properly.

1. Disassemble the pump head as described in Section 10.4.2
2. Rinse connecting plate (3) and intermediate plate (8) and wipe with a soft cloth. Blow dry with compressed air
3. Remove valve seats (5) carefully. The sealing washers (4) are not present in the FT head, see Fig. 66
4. Remove O-Rings (6) and valve disk (7).

**NOTE**

Do not damage the sealing rings.

- Do not use any abrasive agents.
- Do not clean head parts with hard materials.
- Check head parts, especially sealing edges and seal faces, for damage
- Replace any damaged parts

5. Wash all parts with flushing agent and blow dry with compressed air
6. Wipe the pump diaphragm with a soft damp cloth
7. Assemble the pump head as described in Section 10.4.2
8. Check that the pump is leak-tight (see Section 10.5)

- 1 Head screws
- 2 Head plate
- 3 Connecting plate
- 4 Sealing washer
- 5 Valve seat
- 6 O-ring
- 7 Valve disk
- 8 Intermediate plate

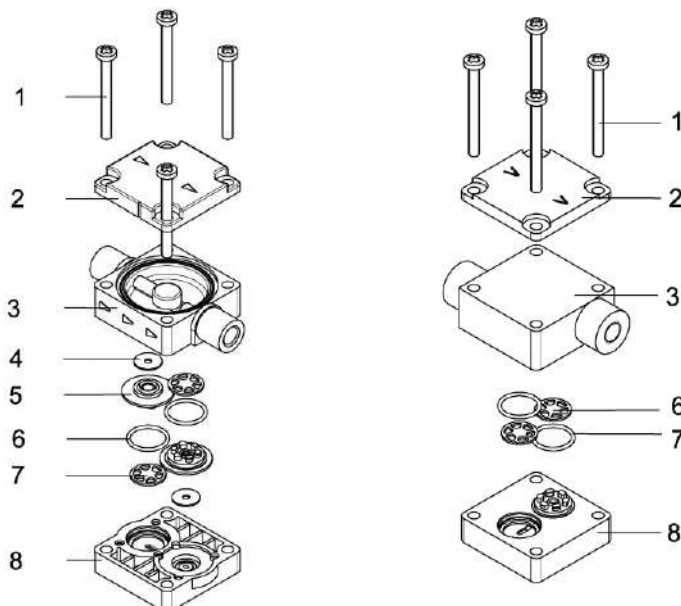

Fig. 66: Head, KT, TT

Head, FT

## 10.4.2 Replacing the valve

**⚠ WARNING****Danger of poisoning/injuries as a result of choosing the wrong valve material**

Aggressive media alter valve materials, thus preventing the pump from working properly

- Determine the resistance of the valve material – see Section 4.3 or the chemical resistance list ([www.knf.com/downloads](http://www.knf.com/downloads))
- Use resistant valve materials and mark the pump accordingly, also
- marking if it deviates from the standard



Ensure cleanliness when replacing valves, as pollution/contamination may prevent the valve from working properly.

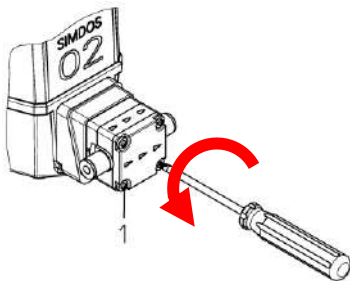

1. Undo head screws (1)

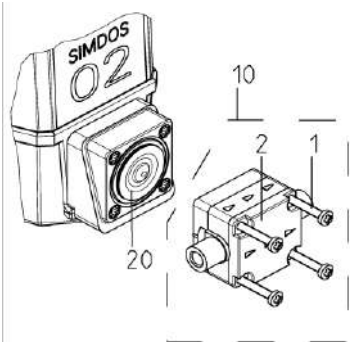

2. Completely remove head (10)
3. Remove head plate (2) and head screws (1)
4. Check diaphragms (20) for damage and replace where necessary

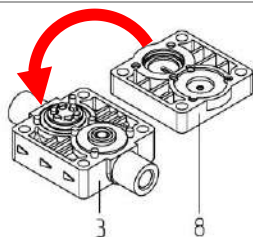

5. Fold the connecting plate (3) and the intermediate plate (8) apart

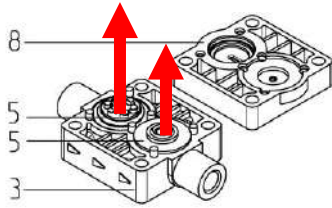

6. Remove valve seats (5) carefully

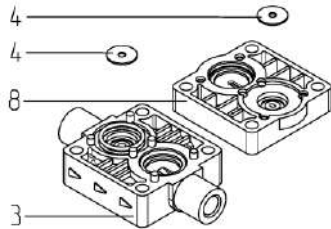

7. Replace sealing washers (4)

The FT head does not contain a sealing washer or valve seats

**Caution!**

Sealing washer must lie flat in the valve seat, otherwise pump will not be leak-tight

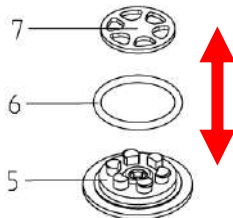

8. Remove valve disks (7) and O-rings (6)

9. Fit O-rings (6) flat on the base, taking care not to twist them

10. Fit valve disks (7), which must lie flat on the valve

**Caution!** Observe material coding (below)

11. Check valve material before using. For further information, see Section 4.3

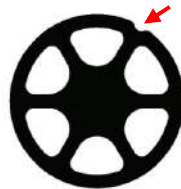

DuPont™ Kalrez®

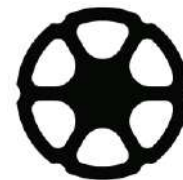

CHEMRAZ®

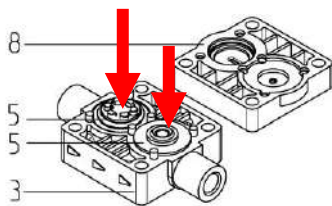

12. Place pre-assembled valve seats (5) in connecting plate (3)

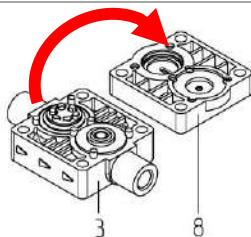
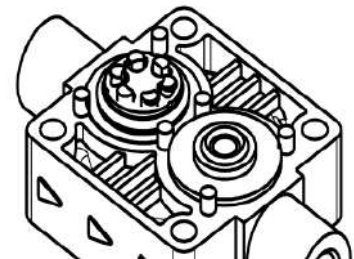

13. Fit the connecting plate (2) and the intermediate plate (1) together

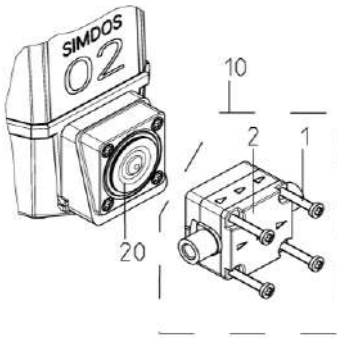

14. Assemble head plate (2) and head screws (1) with head (following the direction of the arrows)

**Caution!**

Once fitted together, the seals and O-rings must not be moved again

- Hold the complete head together

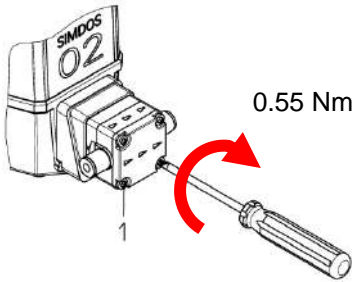

15. Fully assemble head (10)

16. Tighten head screws (1) to 0.55 Nm.

17. Check that the pump is leak-tight (see Section 10.5)

### 10.4.3 Replacing the pump diaphragm

|                                      |   |
|--------------------------------------|---|
| <p>Prior requirements</p>            | <ul style="list-style-type: none"> <li>▪ Pump must be free of any hazardous substances</li> <li>▪ Hoses must be disconnected from the pump head</li> <li>▪ Pump is connected to the mains</li> </ul>                  |
| <p>Personnel</p>                     | <ul style="list-style-type: none"> <li>▪ specialist personnel trained by KNF</li> </ul>   |
| <p>Personal protective equipment</p> | <ul style="list-style-type: none"> <li>▪ The type of protective equipment required will depend on the medium to be transferred.</li> <li>▪ Observe the safety data sheets for the media to be transferred.</li> </ul> |

Ensure cleanliness when replacing diaphragms, as pollution/contamination may prevent the pump from working properly.

- 1 Support / Connecting rod
- 2 Insert ring
- 3 Pump diaphragm

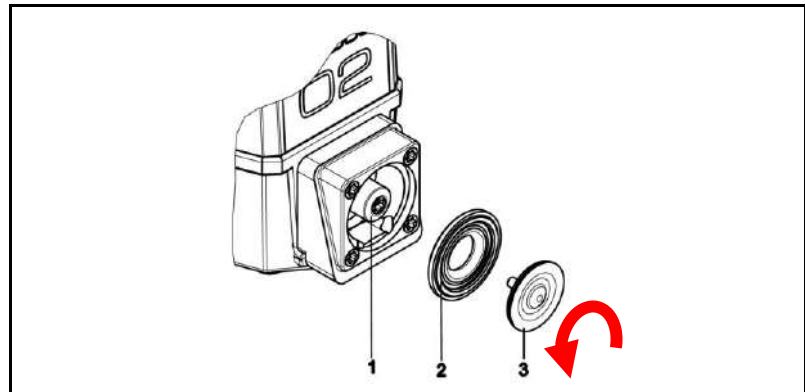

Fig. 67: Replacing the pump diaphragm

#### Removal

1. Activate the diaphragm maintenance function in the pump system menu
2. Disassemble pump head as described in Section 10.4.2
3. Lift pump membrane (3) at opposite side edges, grip and screw out by turning anticlockwise (see arrow in Fig. 67)
4. Inspect all parts for pollution/contamination and damage, cleaning them if necessary

#### Installation

5. Activate diaphragm maintenance in the pump system menu (if no longer active)
6. Fit insert ring (2).
7. Screw pump membrane (3) clockwise onto connecting rod (1) and hand-tighten.
8. Press the "STOP" button,
9. Activate "Prime" in main menu for 2s
  - ➔ Diaphragm moves into housing
10. Assemble the pump head as described in Section 10.4.2.
11. Check that the pump is leak-tight (see Section 10.5)

#### NOTE

If the pump diaphragm is not fitted correctly, the pump may be mechanically obstructed and become damaged as a result.

- Screw the pump membrane in properly as far as it will go
- Do not damage the surface of the diaphragm

## 10.5 Checking that pump is leak-tight

### ⚠ WARNING

#### Danger of bursting of the fluid system as a consequence of overpressure.

The pump builds up pressure. In a closed system the max. permitted operating pressure may be exceeded, thus causing damage to the pump and/or the system.

- In the case of parts that are in contact with the fluid, only select those that are designed for the pump's operating pressure
- Do not transfer against shut-off devices or closed systems, or
- install pressure relief/safety valves and set them to 6 bar (in the KNF product range)



In order to ensure correct assembly and hence reliability, it is essential to perform a leak test.

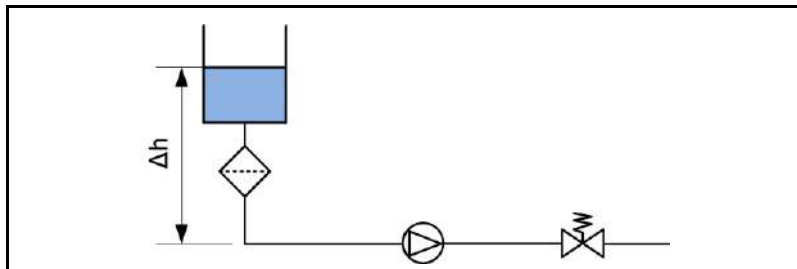

Fig. 68: Pressure test setup

1. Set up the system as shown in Fig. 68.
2. Use distilled water as test medium.
3. Set pressure control valve to working pressure.
4. Make sure that the fitting is leak-tight (see Section 6.2.3).
5. Operate pump carefully for 5 minutes.
6. Check pump for leaks.

If no traces of medium are visible on the head, the pump can be used in accordance with its specification (see Chapter 3).

#### Caution!

If it is found that liquid is escaping, under no circumstances should the pump continue to be used.

1. Check that connections are leak-tight.
2. Check tightening torque of head screws.
3. Check that elastomer parts are clean.
4. Check leak-tightness again.

If these actions have no effect, contact your local KNF dealer and do not under any circumstances continue to use the pump.

## 11 Shutdown

### 11.1 Safety



#### **⚠ DANGER**

##### **Danger of injuries caused by hazardous materials**

Poisoning and caustic burns caused by contact with aggressive, inflammable or radioactive media

- Flush the pump thoroughly (see Chapter 10.2)
- Decontaminate the pump if necessary
- Observe the safety data sheets for the media to be transferred
- Wear suitable protective equipment

The following requirements apply to all the activities described in this chapter:

Prior requirements

Personnel

Personal protective equipment



- System depressurised
- Specialist personnel
- The type of protective equipment required will depend on the medium to be transferred.
- Observe the safety data sheets for the media to be transferred.

1. Flush the whole system including the pump with a neutral liquid
2. Pump the pump empty (see Section 10.2).
3. Press the STOP button to end the transferring operation
4. Unplug the pump from the power supply
5. Dispose of pump properly

## 12 Troubleshooting

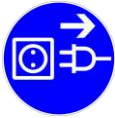

### 12.1 Safety

Disconnect the mains plug from the power supply before working on the pump head.

|                               |   |
|-------------------------------|---|
| Prior requirements            | ▪ Pump has been thoroughly flushed/decontaminated |
| Personnel                     | ▪ Specialist personnel                            |
| Personal protective equipment | ▪ none  |

### 12.2 Displaying of error messages

| Display                 | Description  | Fault remedy   |
|-------------------------|--|--|
| Error 1<br>Motor        | Control deviation too high, motor is over-loaded<br>➤ Pump blocked | ➤ Switch pump on / off                               |
| Error 2<br>Temperature  | Motor overheating  | ➤ Allow pump to cool<br>➤ Reduce ambient temperature |
| Error 3<br>Supply       | Supply voltage is less than 21 V                                   | ➤ Supply with 24 V and sufficient power              |
| Error 4<br>Encoder      | Position measuring malfunction                                     | ➤ Switch pump on / off                               |
| Error 5<br>4 – 20 mA    | Analog set point setting less than 2 mA                            | ➤ Check control signal<br>➤ Check cable              |
| Error 6<br>Flash        | Error in memory  | ➤ Switch pump on / off                               |
| Error 7<br>Overpressure | System pressure exceeds 7 bar                                      | ➤ Check pump for closed valves and blocked filters   |

If the fault cannot be rectified, please contact your local KNF dealer (see last page for address)



### 12.3 Rectifying transfer problems

| Symptom                      | Possible cause   | Fault remedy   |
|------------------------------|--|--|
| Pump cannot be switched on   | Pump not connected to the mains.   | <ol style="list-style-type: none"> <li>1. Connect pump to the mains.</li> <li>2. Check mains voltage</li> </ol>  |
| Pump does not work           | Connections or hoses are blocked.  | <ol style="list-style-type: none"> <li>1. Check hoses and connections.</li> <li>2. Remove blockage.</li> </ol>   |
| Pump does not work           | External valve is closed or filter is clogged or too small.              | <ol style="list-style-type: none"> <li>1. Check external valves and filters.</li> </ol>  |
| Flow rate too low            | Particles in the pump head   | <ol style="list-style-type: none"> <li>1. Clean valves (see Maintenance)</li> <li>2. Clean pump head (see Maintenance)</li> <li>3. Use prefilter</li> </ol>  |
| Insufficient vacuum          |  |  |
| Flow rate too low            | Materials chemically damaged by pumped media.                            | <ol style="list-style-type: none"> <li>1. Select a type of material that is resistant and suitable (see chemical resistance list).</li> <li>2. Replace valves (see Section 10.4)</li> </ol>  |
| Flow rate too low            | Worn diaphragm or valve plates/seals.                                    | <ol style="list-style-type: none"> <li>1. Replace diaphragm and valve plates/seals (see Section 10.4).</li> </ol>  |
| Pump not drawing any vacuum  | Pump can only draw vacuum against atmosphere.                            | <ol style="list-style-type: none"> <li>1. Change pressure conditions on pressure side.</li> </ol>  |
| Unstable flow rate           | Cross-section of hydraulic hoses or connectors too narrow or restricted. | <ol style="list-style-type: none"> <li>1. Disconnect the pump from the system and determine output values.</li> <li>2. Remove restriction (e.g. valve) if necessary.</li> </ol> <p>If applicable, use larger-diameter hoses or connectors.</p> |
| Leakage in pump head         | Worn diaphragm or valve plates/seals.                                    | <ol style="list-style-type: none"> <li>1. Tighten head screws to 0.55 Nm</li> <li>2. Replace diaphragm and valve plates/seals (see Section 10.4).</li> </ol>   |
| Leakage from discharge port. | Leakage at pump diaphragm  | <ol style="list-style-type: none"> <li>1. Contact KNF dealer</li> <li>2. Send pump to KNF dealer for safety check</li> </ol>   |

Tab. 32: Pump does not work

If the fault cannot be rectified, please contact your local KNF dealer (see last page for address)

#### Returning the pump

1. Flush the pump to clear the pump head of any hazardous or aggressive liquids.
2. Disconnect the pump.
3. Send the pump, with completed decontamination declaration (see Chapter 14), to KNF Customer Service stating the nature of the pumped medium (see Arranging for return).

## 13 Spare parts and accessories

### 13.1 Spare parts

| Spare part  | Order No. |
|---|-----------|
| SIMDOS 02 KT Complete Head Kit; Standard Kalrez® (without diaphragm)    | 166297    |
| SIMDOS 02 TT Complete Head Kit; Standard Kalrez® (without diaphragm)    | 166298    |
| SIMDOS 02 FT Complete Head Kit; Standard Kalrez® (without diaphragm)    | 164981    |
| SIMDOS 02 FT Complete Head Kit; Optional, Chemraz® (without dia-phragm) | 164982    |
| SIMDOS 02 ST Complete Head Kit; Standard Kalrez® (without diaphragm)    | 166299    |
| SIMDOS 02 ST Complete Head Kit; Optional, Chemraz® (without diaphragm)  | 166300    |
| SIMDOS Valve Kit Standard Kalrez®                                       | 164983    |
| SIMDOS Valve Kit Optional, Chemraz®                                     | 164984    |
| SIMDOS 02 Diaphragm Kit Standard PTFE                                   | 165442    |
| SIMDOS 02 Diaphragm Kit Standard FFKM                                   | 170867    |

### 13.2 Hoses

| Hoses  | Order No. |
|--|-----------|
| Connection set, AD1/8, UNF 1/4", L=1m; (2 Ferrules and 2 Fittings) | 069790    |
| Hose, FEP, UNF 1/4", screw connection L=1m (1 Fitting)             | 166329    |
| Hose, FEP, UNF 1/4", screw connection L=2m (1 Fitting)             | 166330    |
| Hose, FEP 1/16", Gripper, UNF 1/4", L=1m (1 Fitting)               | 166335    |

### 13.3 Pressure control valve

| Pressure control valve - kit       | Order No. |
|------------------------------------|-----------|
| SIMDOS 02 Accessory Set JFDV 30 KT | 166286    |
| SIMDOS 02 Accessory Set JFDV 30 TT | 166287    |
| SIMDOS 02 Accessory Set JFDV 30 FT | 166288    |

### 13.4 Filter

| Included Filter | Head material | Mesh size | Material* | Order No.       |
|-----------------|---------------|-----------|-----------|-----------------|
| Filter FS 60 T  | TT            | 70µm      | PVDF      | 346932 (1 pc)   |
| Filter FS 60 T  | TT            | 70µm      | PVDF      | 346933 (10 pcs) |
| Filter FS 60 X  | KT, FT, ST    | 35µm      | PEEK      | 323625 (1 pc)   |
| Filter FS 60 X  | KT, FT, ST    | 35µm      | PEEK      | 323626 (10 pcs) |

\*material for housing and filter mesh

### 13.5 Foot switch

| Foot switch       | Order No. |
|-------------------|-----------|
| Pulse foot switch | 155872    |

### 13.6 Fastening material

| Fasteners      | Order No. |
|----------------|-----------|
| Tripod holder  | 160474    |
| Mounting plate | 160473    |

## 14 Decontamination declaration

**NOTE**

KNF shall only undertake to repair the pump on condition that the customer provides certification of the transferred media and the cleaning of the pump (decontamination declaration).

KNF Flodos AG  
 Wassermatte 2  
 6210 Sursee, Switzerland  
 Tel +41 (0)41 925 00 25  
 Fax +41 (0)41 925 00 35  
 www.knf.com

1. Copy this page, or print out the decontamination declaration from our website <http://www.knf.com/downloads>.
2. Enter the pump model, the Serial No. and the transferred media in the form below and send the signed form together with the flushed and cleaned pump to KNF Customer Service.

### Customer decontamination declaration for repair order

We confirm that the pump below has been used to pump the following media, and that the pump has been flushed and cleaned.

|              |  |
|--------------|--|
| Pump model   |  |
| Serial No.   |  |
| Pumped media |  |
|              |  |
|              |  |
|              |  |
|              |  |

The pump does not contain aggressive, biological, radioactive, poisonous, or other dangerous media.

.....  
 Company

.....  
 Date/Signature

