

# TM4411

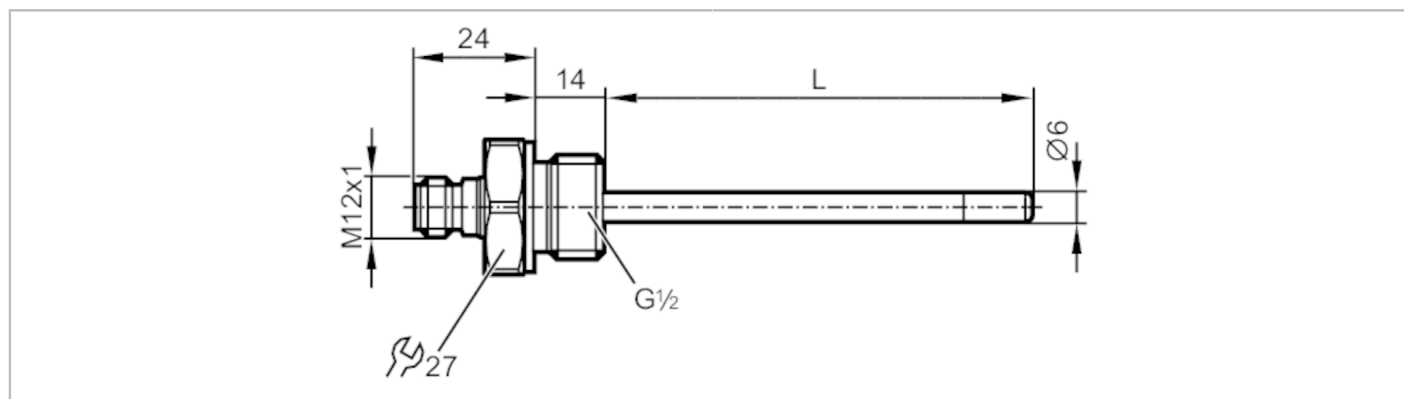

## Temperature sensor with process connection

TM-050KFBR12- /US/



Product characteristics		
Measuring range	-40...150 °C	-40...302 °F
Process connection	threaded connection G 1/2 external thread	
Installation length EL [mm]	50	
Application		
System	gold-plated contacts	
Measuring element	1 x Pt 100; (to DIN EN 60751, class A)	
Media	liquids and gases	
Pressure rating	250 bar	25 MPa
Minimum installation depth [mm]	15	
Electrical data		
Protection class	III	
Measuring/setting range		
Probe length L [mm]	36	
Measuring range	-40...150 °C	-40...302 °F
Accuracy / deviations		
Accuracy [K]	± (0,15 K + 0,002 x t )	
Reaction times		
Dynamic response T05 / T09 [s]	1 / 3; (according to DIN EN 60751)	
Operating conditions		
Ambient temperature [°C]	-25...80	
Storage temperature [°C]	-40...100	
Protection	IP 68; IP 69K	
Tests / approvals		
Shock resistance	DIN EN 60068-2-2-27	50 g (11 ms)
Vibration resistance	DIN EN 60068-2-6	10 g (10...2000 Hz)
MTTF [years]	22831	
Mechanical data		
Weight [g]	128	
Housing	tubular	
Dimensions [mm]	Ø 30 / L = 74	

# TM4411



## Temperature sensor with process connection

TM-050KFBR12- /US/

Material	stainless steel (1.4404 / 316L)
Materials (wetted parts)	stainless steel (1.4404 / 316L); FKM
Tightening torque [Nm]	45
Process connection	threaded connection G 1/2 external thread
Probe diameter [mm]	6
Installation length EL [mm]	50

Remarks	
Remarks	cULus - Class 2 source required The values for accuracy apply to flowing water.
Pack quantity	1 pcs.

### Electrical connection

Connector: 1 x M12; coding: A; Contacts: gold-plated



### Connection

