

SV8150



Vortex flow meter

SVM54XXXD0KG/US-100

Article to be discontinued
Discontinuation date: 12/31/2025

Alternative articles: SV8151
When selecting an alternative article and accessories please note that technical data may differ!

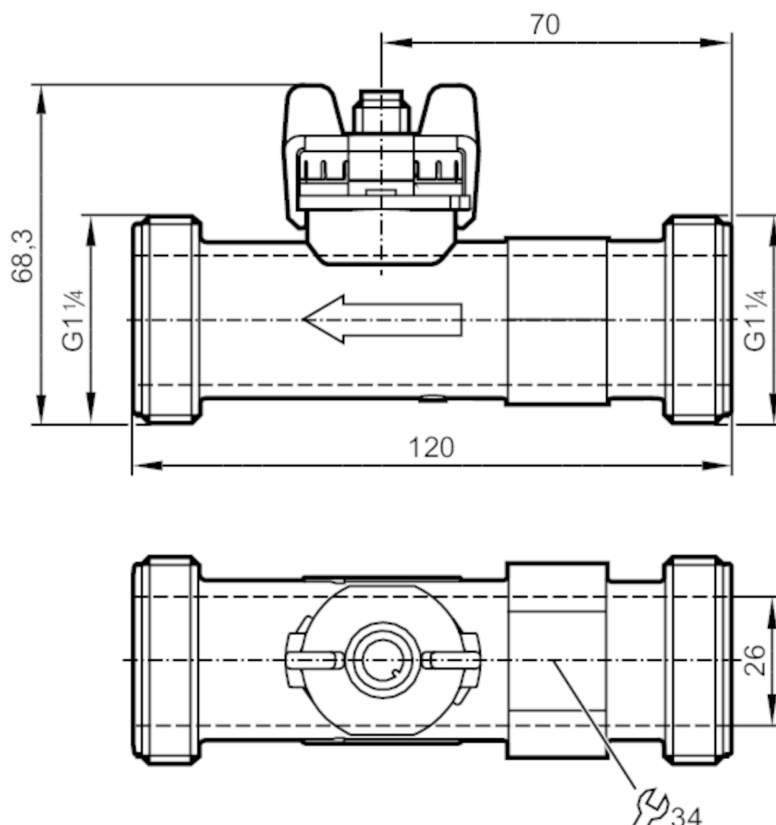

Product characteristics

Number of inputs and outputs	Number of analog outputs: 1	
Measuring range	9...150 l/min	0.283...4.709 m/s
Process connection	threaded connection G 1 1/4 external thread DN25	

Application

System	gold-plated contacts	
Measuring element	1 x Pt 1000; (to DIN EN 60751, class B)	
Application	for industrial applications	
Installation	connection to pipe by means of an adapter	
Media	water; glycol solutions; Coolants	
Medium temperature [°C]	-40...100	
Min. burst pressure	25 bar	2.5 MPa
Pressure rating	12 bar	1.2 MPa
Note on pressure rating	up to 40 °C	

SV8150



Vortex flow meter

SVM54XXXD0KG/US-100

Electrical data		
Operating voltage [V]		8...33 DC
Min. insulation resistance [MΩ]		100; (500 V DC)
Protection class		III
Power-on delay time [s]		< 2
Measuring principle		Vortex
Inputs / outputs		
Number of inputs and outputs		Number of analog outputs: 1
Outputs		
Total number of outputs		1
Output signal		analog signal
Number of analog outputs		1
Analog current output [mA]		4...20; (water: $Q [l/min] = 9,375 \times (I - 4 \text{ mA})$; water-glycol: $Q [l/min] = 9,375 \times (I - 4 \text{ mA}) - Q_0$ see Figure 2)
Max. load [Ω]		$< (U_b - 8 \text{ V}) / 20 \text{ mA}$; $U_b = 24 \text{ V}$: 800
Measuring/setting range		
Measuring range	9...150 l/min	0.283...4.709 m/s
Temperature monitoring		
Internal heating temperature probe		1 K/mW
Measuring range [°C]		-40...100
Accuracy / deviations		
Flow monitoring		
Accuracy (in the measuring range)		$Q < 50 \% \text{ MEW}: < 1 \% \text{ MEW} / Q > 50 \% \text{ MEW}: < 2 \% \text{ MW}$; (water)
Repeatability		0,2; (% of the final value)
Temperature monitoring		
Accuracy [K]		$\pm 0,3 \pm 0,005 \times T$
Reaction times		
Flow monitoring		
Response time [s]		0.5
Operating conditions		
Ambient temperature [°C]		-15...85
Note on ambient temperature		medium temperature $> 0 \text{ °C}$: -30...85
Storage temperature [°C]		-30...85
Protection		IP 65
Cavitation		$P(\text{absolute discharge}) / P(\text{difference}) > 5.5$ to avoid cavitation
Tests / approvals		
EMC	EN 61326-2-3	
Shock resistance	DIN EN 60068-2-27	30 g (11 ms)
Vibration resistance	DIN EN 60068-2-6	with water / 10...61 Hz 1 mm with water / 61...2000 Hz 2 g
MTTF [years]		380
Pressure equipment directive		sound engineering practice; can be used for group 2 fluids; group 1 fluids on request

SV8150



Vortex flow meter

SVM54XXXD0KG/US-100

Mechanical data		
Weight	[g]	136.2
Housing		rectangular
Dimensions	[mm]	120 x 41.91 x 68.3
Material		PA 6T
Materials (wetted parts)		ETFE; PA 6T; EPDM
Tightening torque	[Nm]	15
Process connection		threaded connection G 1 1/4 external thread DN25

Remarks	
Remarks	MW = Measured value MEW = Final value of the measuring range
Pack quantity	1 pcs.

Electrical connection

Connector: 1 x M12; coding: A; Contacts: gold-plated

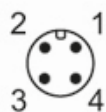

Connection

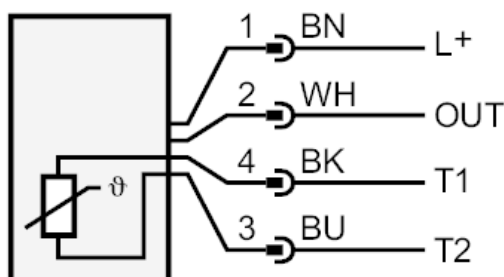

OUT: analog output
T1 / T2: Pt1000
Colors to DIN EN 60947-5-2
Core colors :
BK = black
BN = brown
BU = blue
WH = white

SV8150



Vortex flow meter

SVM54XXXD0KG/US-100

Diagrams and graphs

Pressure loss

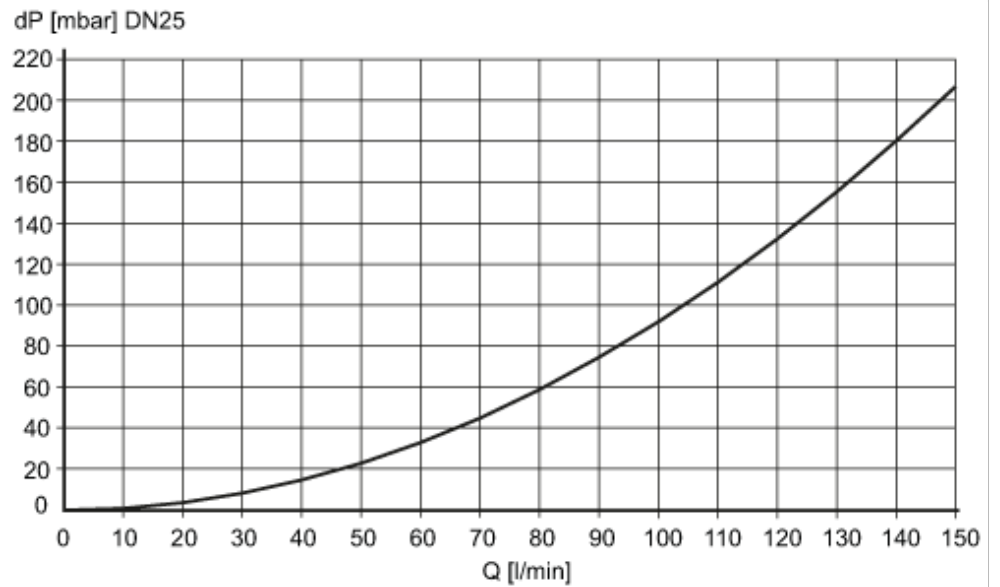

dP Pressure loss

Q volumetric flow quantity

Minimum lifetime 10 years referred to flow and high medium temperatures

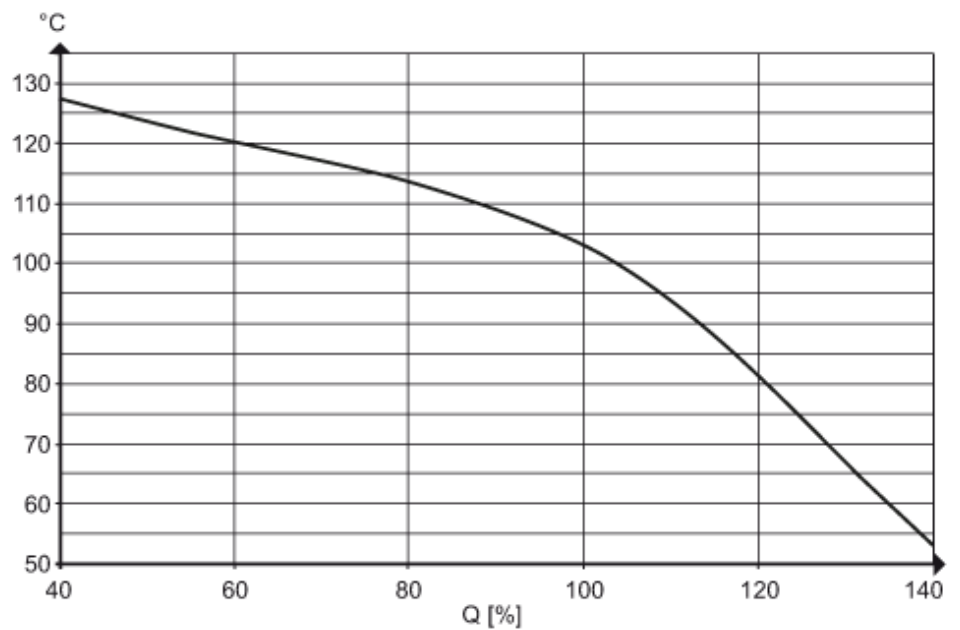

SV8150



Vortex flow meter

SVM54XXXD0KG/US-100

Determination of the kinematic viscosity (ν) of glycol-water mixtures depending on the temperature

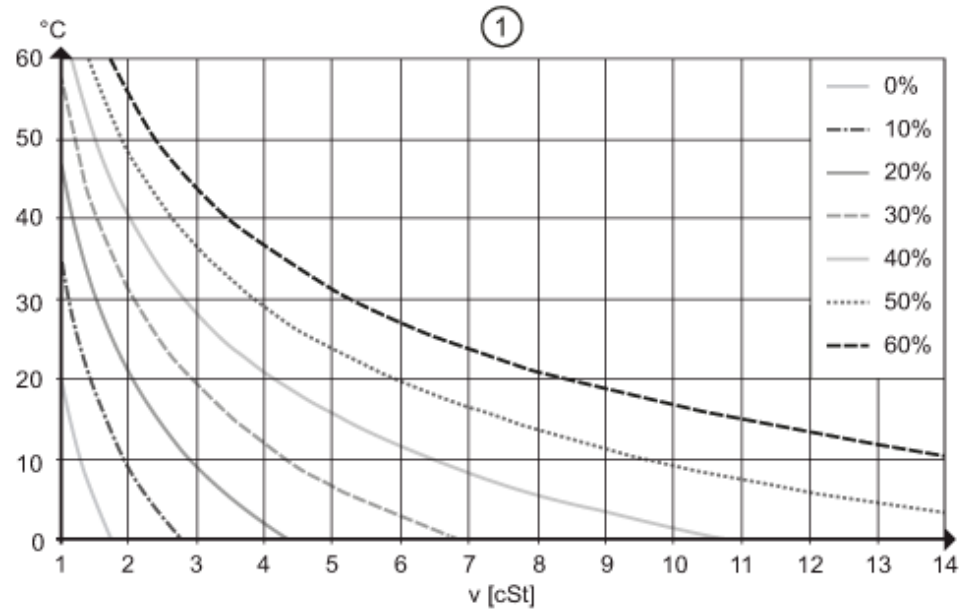

determination of the compensation value Q_0 for glycol-water mixtures

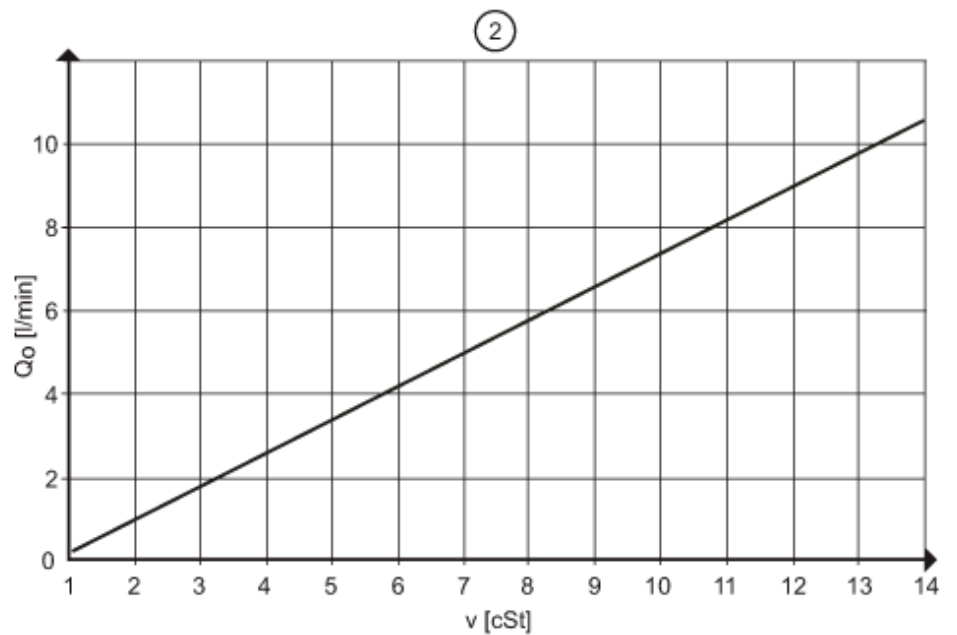

$\nu < 4$ cSt measuring accuracy 3% MEW

$4 < \nu < 14$ cSt measuring accuracy 4% MEW

SV8150



Vortex flow meter

SVM54XXXD0KG/US-100

Response threshold Q_{\min} (l/min)
depending on the kinematic viscosity

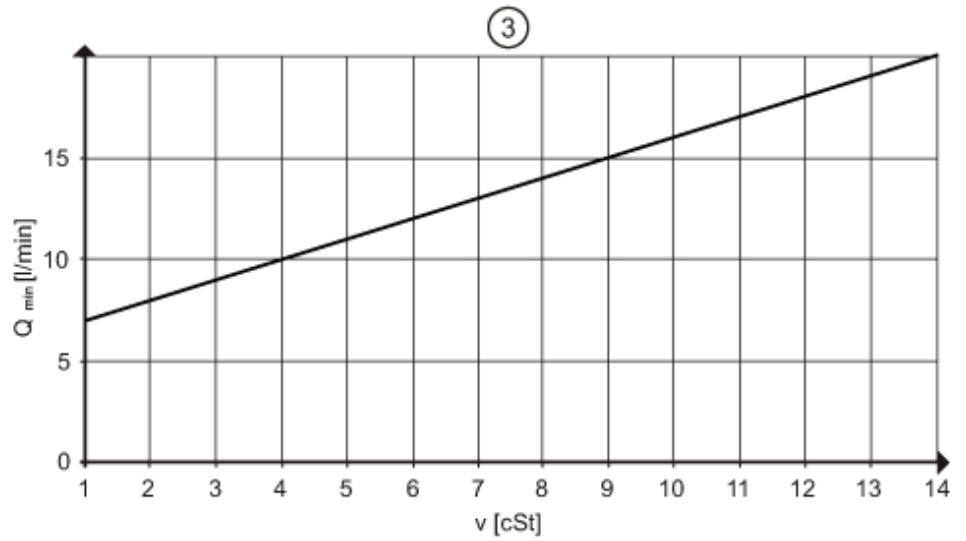

pressure rating (bar)

