

SF5704

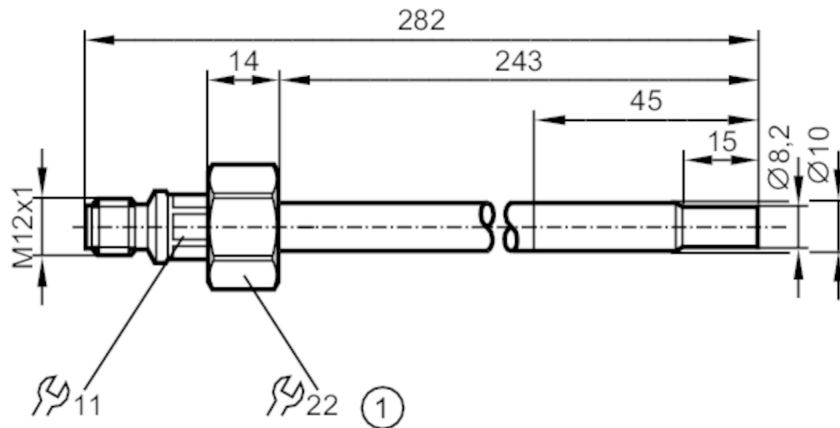

Flow sensor for connection to an evaluation unit

SFD10ADT /US-100



1 Internal thread M18 x 1,5



Product characteristics

Probe length L	[mm]	243
Process connection		threaded connection M18 x 1,5 Internal thread

Application

Media		Liquids; Gases; aggressive media
Medium temperature	[°C]	-25...80
Pressure rating		100 bar 10 MPa

Electrical data

Connection to control monitor		VS3000
-------------------------------	--	--------

Measuring/setting range

Probe length L	[mm]	243
Liquids		
Setting range	[cm/s]	3...300
Greatest sensitivity	[cm/s]	3...60
Gases		
Setting range	[cm/s]	200...3000
Greatest sensitivity	[cm/s]	200...800

Accuracy / deviations

Max. temperature gradient of [K/min] medium		300
---	--	-----

Reaction times

Response time	[s]	1...10
---------------	-----	--------

Operating conditions

Storage temperature	[°C]	-25...80
Protection		IP 67

Tests / approvals

Shock resistance	DIN IEC 68-2-27	50 g (11 ms)
Vibration resistance	DIN IEC 68-2-6	10 g (55...2000 Hz)
MTTF	[years]	8393.77

SF5704



Flow sensor for connection to an evaluation unit

SFD10ADT /US-100

Mechanical data	
Weight [g]	95
Housing	tubular
Dimensions [mm]	Ø 8.2 / L = 282
Material	titanium (3.7035); EPDM; ULTEM
Materials (wetted parts)	titanium (3.7035); O-ring: FKM 80 Shore A
Process connection	threaded connection M18 x 1,5 Internal thread
Probe diameter [mm]	8.2
Installation length EL [mm]	243

Remarks	
Pack quantity	1 pcs.

Electrical connection

Connector: 1 x M12; coding: A; Maximum cable length: 100 m

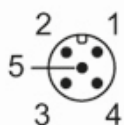

Connection

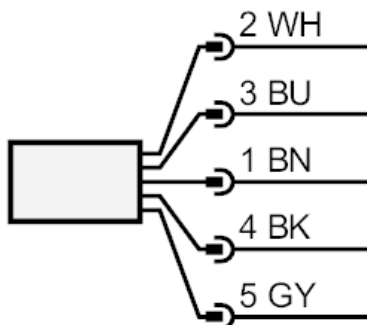

Core colors :
BN = brown
BU = blue
BK = black
WH = white
GY = grey