

EVCB24

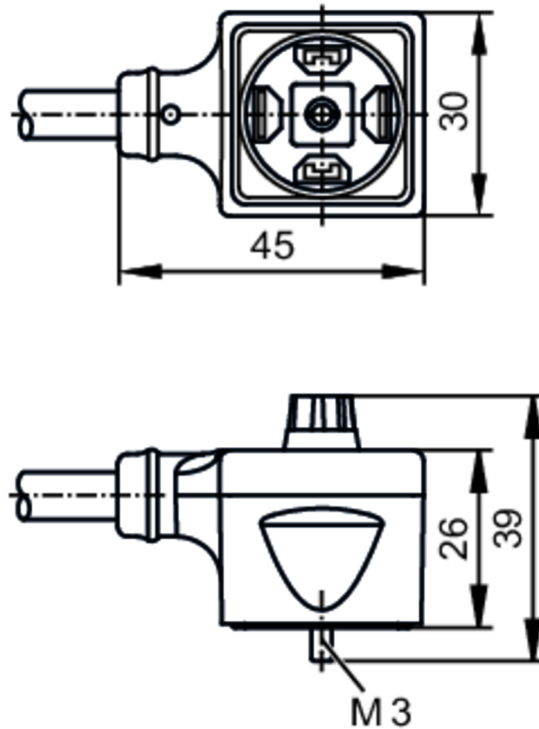

Connection cable with valve plug

AVDAA031--S0001H03



Application	
System	Free from silicone; Halogen-free; Drag chain suitability
Application	Industrial applications; Oils and coolants
Free from silicone	yes
Electrical data	
Operating voltage [V]	< 24 AC/DC
Current consumption [mA]	< 4; (U _b = 24V)
Overvoltage protection	yes; (VDR)
Max. current load total [A]	5
Operating conditions	
Ambient temperature [°C]	-20...90
Ambient temperature (moving) [°C]	-25...90
Storage temperature [°C]	-25...55
Storage humidity [%]	10...100
Other climatic conditions for storage according to stated class	1K22/ DIN 60721-3-1
Protection	IP 67; IP 68; IP 69K
Mechanical data	
Weight [g]	85.8

EVCB24



Connection cable with valve plug

AVDAA031--S0001H03

Material	housing: PA	
Molded-body material	TPU (urethane)	
Sealing material	HNBR	
Drag chain suitability	yes	
Drag chain suitability	Bending radius for flexible applications	min. 10 x cable diameter
	Travel speed	max. 3.3 m/s for a horizontal travel length of 5 m and max. acceleration of 5 m/s ²
	Bending cycles	> 5 Mio.
	Torsional strain	± 180 °/m

Displays / operating elements

Display	Switching status	1 x LED, yellow
---------	------------------	-----------------

Remarks

Pack quantity	1 pcs.
---------------	--------

Electrical connection

Cable: 1 m, PUR, Halogen-free, Ø 5.4 mm; 3 x 0.75 mm² / AWG 19

Electrical connection - Socket

Connector: 1 x valve type A DIN (EN 175301-803), angled; Moulded body: TPU (urethane), black; sealing: HNBR; Tightening torque: 0.3...0.4 Nm

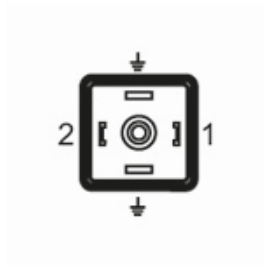

Connection

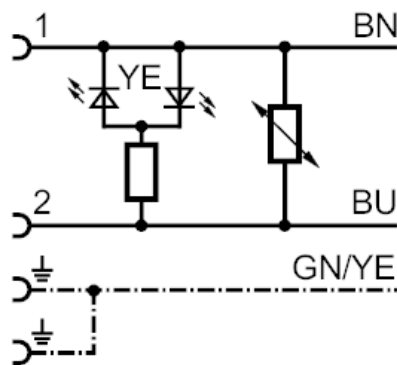

Core colors :
 BN = brown
 BU = blue
 GN/YE = green/yellow