

EVC197



Female cordset

ADOGH050MSS0015H05

Please see the technical note under "Downloads"

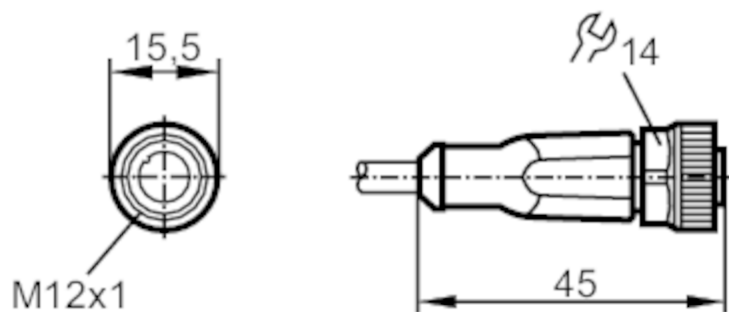

Application	
System	Free from silicone; Halogen-free; gold-plated contacts; Drag chain suitability
Application	Industrial applications; Oils and coolants
Free from silicone	yes
Electrical data	
Operating voltage [V]	< 60 AC/DC
Protection class	II
Max. current load total [A]	4
Overall current rating (UL) [A]	3
Operating conditions	
Ambient temperature [°C]	-25...90
Note on ambient temperature	cULus: ...75
Ambient temperature (moving) [°C]	-25...90
Note on ambient temperature (moving)	cULus: ...75
Storage temperature [°C]	-25...55
Storage humidity [%]	10...100
Other climatic conditions for storage according to stated class	1K22/ DIN 60721-3-1
Protection	IP 65; IP 67; IP 68; IP 69K

EVC197



Female cordset

ADOGH050MSS0015H05

Mechanical data		
Weight [g]	492.8	
Dimensions [mm]	15.5 x 15.5 x 45	
Molded-body material	TPU (urethane)	
Material nut	brass, nickel-plated	
Sealing material	FKM	
Drag chain suitability	yes	
Drag chain suitability	Bending radius for flexible applications	min. 10 x cable diameter
	Travel speed	max. 3.3 m/s for a horizontal travel length of 5 m and max. acceleration of 5 m/s ²
	Bending cycles	> 5 Mio.
	Torsional strain	± 180 °/m

Remarks	
Notes	Please see the technical note under "Downloads"
Pack quantity	1 pcs.

Electrical connection	
Cable: 15 m, PUR, Halogen-free, black, Ø 4.6 mm; 5 x 0.34 mm ² (42 x Ø 0.1 mm)	

Electrical connection - Socket	
Connector: 1 x M12, straight; coding: A; Moulded body: TPU (urethane), orange; Locking: brass, nickel-plated; sealing: FKM; Contacts: gold-plated; Tightening torque: 0.6...1.5 Nm	

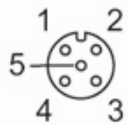

Connection

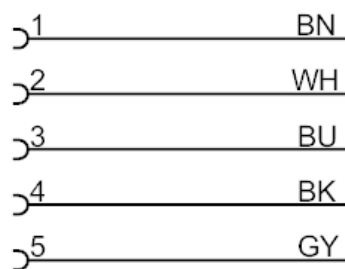

	Core colors :
BK =	black
BN =	brown
BU =	blue
GY =	grey
WH =	white

EVC197



Female cordset

ADOGH050MSS0015H05

Diagrams and graphs

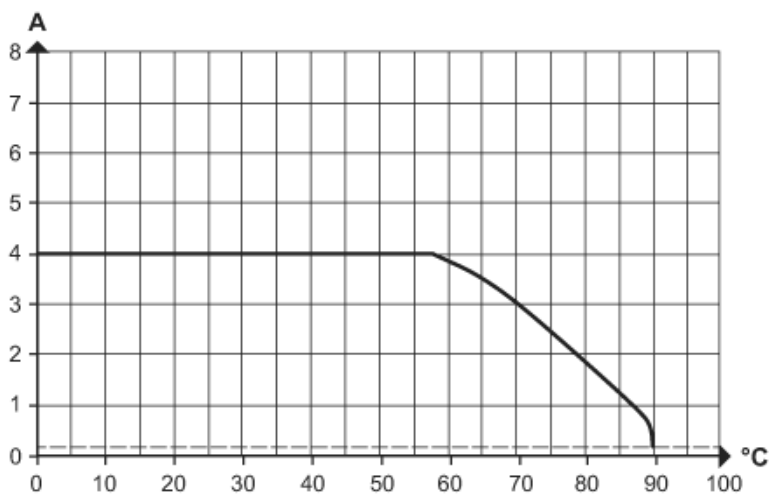

Derating $I_{max} * 0.8$ DIN EN 60512-5-2

X Ambient temperature [°C]

Y Current [A]