

E12838

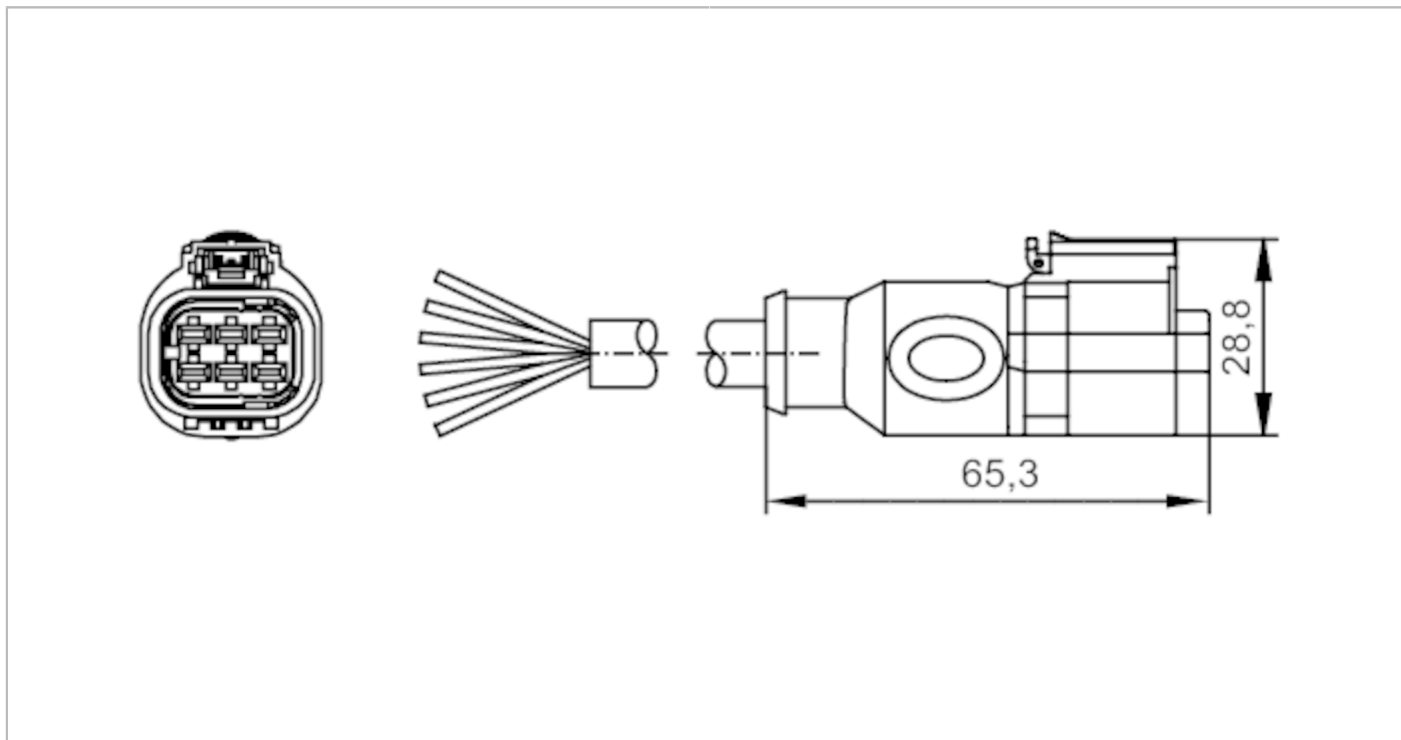

Connecting cordset with AMP connector

ADOGX060--D0015H06



Application		
System	Halogen-free; Drag chain suitability	
Application	CAN bus; for mobile applications	
Electrical data		
Operating voltage [V]	12...24 DC	
Protection class	III	
Max. current load total [A]	17; (wires 2+5: 4 A)	
Operating conditions		
Ambient temperature [°C]	-40...80	
Ambient temperature (moving) [°C]	-30...80	
Protection	IP 65; IP 67; (mating connector plugged in)	
Mechanical data		
Weight [g]	2566.2	
Molded-body material	TPU (urethane)	
Sealing material	silicone	
Drag chain suitability	yes	
Drag chain suitability	Bending radius for flexible applications	min. 10 x cable diameter
	Travel speed	max. 3.3 m/s for a horizontal travel length of 5 m and max. acceleration of 5 m/s ²
	Bending cycles	> 5 Mio.
	Torsional strain	± 180 °/m
Remarks		
Remarks	Bending radius for flexible applications: min. 15 x cable diameter	

E12838



Connecting cordset with AMP connector

ADOGX060--D0015H06

Pack quantity

1 pcs.

Electrical connection

Cable: 15 m, PUR, Halogen-free, black, Ø 10 mm; 2 x 0.5 mm² (16 x Ø 0.2 mm) + 4 x 2.5 mm² (140 x Ø 0.15 mm)

Electrical connection - Socket

Connector: 1 x AMP connector, straight; Moulded body: TPU (urethane), black; sealing: silicone



Connection

