

## LR36, LR41 & LR46 Series Manual



## TABLE OF CONTENTS

	Page
<b>Section One   Introduction:</b> .....	2
Table of Contents: .....	2
Sensor Models: .....	5
Operating Principle: .....	5
Features: .....	5
Benefits: .....	5
Limitations: .....	5
Specifications: .....	6
Intrinsically Safe Control Drawing: .....	10
Labels for Intrinsic Safety:.....	11
Dimensions: .....	12
Safety Precautions: .....	14
<b>Section Two   Getting Started:</b> .....	15
Setup Overview: .....	15
Part Number: .....	17
<b>Section Three   Install Sensor:</b> .....	19
Installation Requirements: .....	19
Air Purging (LR41 series only): .....	19
FCC Conformity: .....	20
LR36 & LR41 Antenna Preparation: .....	21
LR46 Antenna Preparation: .....	22
Flange Riser Installation: .....	22
Beam Angle: .....	23
Gimbal Mounts (for Solids): .....	24
Solids Installation Tips: .....	24
<b>Section Four   Wire Sensor:</b> .....	26
Terminal Wiring: .....	26
HART® Wiring: .....	27
HART® Device descriptors (DD files): .....	27
Standard vs Multidrop: .....	27
Wiring to Displays, Controllers & PLCs: .....	28

<b>Section Five   Configuration:</b> .....	30
Basic Configuration Overview: .....	30
Basic HART communicator overview:.....	31
Units of Measurement: .....	32
Sensor Height: .....	32
Fill-Height: .....	33
Maximum Range: .....	33
Dead Band: .....	34
Echo Curve: .....	34
Using the Display: .....	35
Changing Display Values: .....	36
Step 1 - Measure the Tank: .....	37
Step 2 - Set the Units of Measurement: .....	38
Step 3 - Set the Empty Configuration (4mA): .....	39
Step 4 - Set the Full Configuration (20mA): .....	40
Step 5 - Set the Range (Maximum Range): .....	41
Step 6 - Set the Dead Band: .....	42
Step 7 - Check the Echo Curve: .....	43
<b>Section Six   Process Adjustments:</b> .....	44
Process Adjustments Overview: .....	44
Fast Filling or Emptying of Media: .....	45
Solids with Low Dielectric:.....	46
Solids with Moderate or Significant Powders or Dust:.....	47
Solids with Large Angle of Repose: .....	48
Solids Requiring First Echo Adjustment: .....	49
<b>Section Seven   Advanced Adjustments:</b> .....	50
Advanced Adjustments Overview: .....	50
4-20mA Reverse Output: .....	51
Fail-Safe Output: .....	52
Minimum Current Output: .....	53
HART® Operation Mode:.....	54
Create a New False Echo Curve: .....	55
Update an Existing False Echo Curve: .....	56
<b>Section Eight   Troubleshooting:</b> .....	57
Troubleshooting Overview: .....	57
Measurement Status: .....	58
Peak Values: .....	59
Simulation: .....	60
First Echo Adjustment: .....	61
Echo Curve Zoom: .....	62
False Echo Curve Delete: .....	63
Reset: .....	64

<b>Section Nine   Appendix:</b> .....	65
Configuration Menu: .....	65
Empty Configuration: .....	66
Full Configuration: .....	66
Medium: .....	67
Liquids:.....	67
Solids: .....	68
Low Dielectric: .....	69
Dampen: .....	69
Scaled Units: .....	69
Range: .....	70
Dead Band: .....	70
Display Menu: .....	71
Display Value: .....	71
LCD Contrast: .....	71
Diagnostics Menu: .....	72
Peak Values: .....	72
Measurement Status: .....	72
Echo Curve: .....	73
Simulation: .....	73
Service Menu: .....	74
False Echo: .....	75
Output Settings: .....	75
Reset: .....	76
Units of Measurement: .....	76
Operational Mode: .....	76
Language: .....	76
Information: .....	77
Factory Settings: .....	78
User Configuration: .....	78
Troubleshooting: .....	79
<b>Section Ten   Warranty, Returns and Limitations:</b> .....	<b>80</b>
Warranty: .....	80
Returns: .....	80
Limitations:.....	80

**SENSOR MODELS**

Offered in three different models, EchoPro® is an intrinsically safe, two-wire, pulse radar level sensor that provides a continuous 4-20 mA current output that's proportional to the media level in a tank or sump. Make sure that the model purchased is appropriate for your application.

Series	Max. Range	Beam Angle	Material	Mounting	FCC Compliance	Application
LR36	49.2' (15m)	8° (4" horn)	316L SS	1-1/2" NPT 4" gimbaled flange	Part 15.256, Class B	Solids with normal temperature and normal pressure under 32.8' (10m)
LR41	229.7' (70m)	8° (4" horn)	316L SS	1-1/2" NPT 4" gimbaled flange	Part 15.256, Class B	Solids with dew / dust / crystal under 98.4' (30m)
LR46	229.7' (70m)	5° (8" parabolic)	316L SS	1-1/2" NPT 4" gimbaled flange 4", 8" or 10" flange	Part 15.256, Class B	Solids with strong dew / dust / crystal or ranges over 98.4' (30m)
		4° (10" parabolic)				

**OPERATING PRINCIPLE**

The sensor emits a microwave pulse from its antenna, which travels at the speed of light to the surface of the medium below. A portion of that energy reflects off the medium and returns to the antenna. The time gap between energy emission and receipt is called the "time of flight", and is proportional to the distance between the medium surface and the sensors measurement location, as at the bottom of the antenna. The sensor measures the time of flight and translates this value into a continuous 4-20mA signal output that's proportionate to level within a defined measurement span.

**FEATURES**

- Easy configuration with LCD push button display module
- Adjustable loop fail-safe, no change, 20.5 mA, 22 mA
- Small 12" (30.48cm) dead band enables full bin measurement
- Recognition, storage and deletion of false echo signal returns

**BENEFITS**

- Unaffected by physical process and environmental conditions
- Ideal for applications with dust and/or varying angles of repose
- Strong signal penetrability with minimal attenuation over distance

**LIMITATIONS (FACTORS THAT COULD INFLUENCE PERFORMANCE)**

- Air particulates with a high dielectric constant value such as lead or ferroalloy
- Highly dense air particulates that attenuate microwave emission and receipt
- Material build-up on the antenna that degrades microwave emission and receipt
- Mediums that have an extremely low dielectric constant value with little reflectivity

**SPECIFICATIONS**

Measurement Range: (maximum)	LR36: . 49.2 feet (15m) LR41: 229.7 feet (70m) LR46: 229.7 feet (70m)
Dead Band:	12" (30.48cm) / Factory Set - <b>Note:</b> <i>Can be lowered to 2" from the bottom of the antenna</i>
Measurement Accuracy: (see charts on pages 8 & 9)	LR36: . ±10mm LR41: ±15mm LR46: ±15mm
Display Resolution:	1 mm
Frequency Range:	26 GHz
Measurement Interval:	About 1 sec (dependent on configuration settings)
Adjustment Time:	About 1 sec (dependent on configuration settings)
Beam Angle:	LR36: 8° - 4" (98mm) Horn LR41: 8° - 4" (98mm) Horn LR46: 5° - 8" (196mm) Horn 4° - 10" (246mm) Horn
Process Connection:	LR36: 1-1/2" NPT 4" Gimbaled Flange LR41: 1-1/2" NPT 4" Gimbaled Flange LR46: 1-1/2" NPT 4" Gimbaled Flange

## Material:

Series	LR36	LR41	LR46
Flange	316L SS		
Enclosure	316L SS		
Antenna	316L SS		
Extension	N/A		
Seal	Viton®		
Seal Ring	Silicone (between housing and cap)		
Window	Polycarbonate		
Ground Terminal	Stainless Steel		

Weight:	LR36: 13.2 lbs (6kg)
Depends on process connection size and housing configuration	LR41: 15.4 lbs (7kg) LR46: 15.4 lbs (7kg)
Temperature (Process):	LR36: F: -40° to 392° C: -40° to 200° LR41: F: -76° to 752° C: -60° to 400° LR46: F: -76° to 752° C: -60° to 400°
Temperature compensation:	Automatic
Temperature (Storage):	F: -40° to 176° C: -40° to 80°
Relative Humidity:	<95%
Process Pressure:	LR36: -14.5 to 580 psi (-1 to 40 bar) LR41: -14.5 to 580 psi (-1 to 40 bar) LR46: -14.5 to 580 psi (-1 to 40 bar)
Vibration Proof:	Mechanical vibration 10m/s, 10m <sup>2</sup> /s, 10 -150 Hz
Output:	
Signal Output:	4-20mA
Signal Invert:	4-20mA, 20-4 mA
Resolution:	1.6µA
Fail-Safe Setting:	20.5mA, 22mA or no change
Integration Time:	0-40 sec, adjustable
Load Resistance:	See chart below

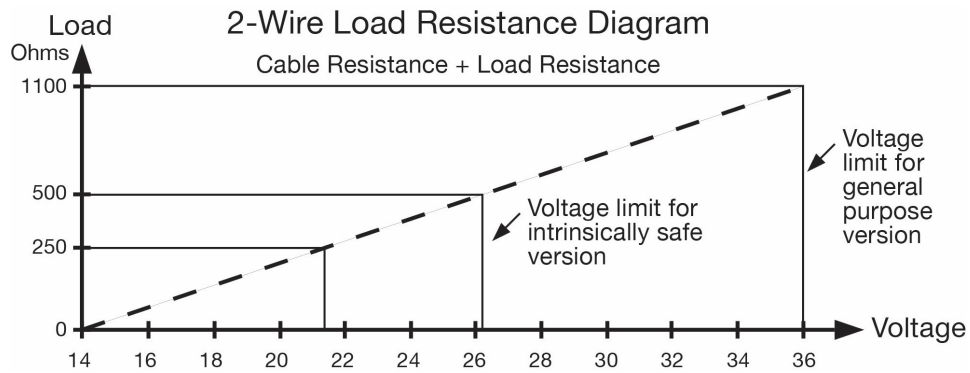

Power:

Power Supply: 24 VDC (21.6 to 26.4 VDC) the same two-wire connection cable carries power supply and current signal.

Power Consumption: 22.5mA maximum

Ripple Allowed:

<100Hz: <1V

100 to 100 KHz: <10mV

Enclosure Rating: IP67 (NEMA 6)

Cable Connection: Standard 2-wire shielded cable with earth ground wire and outside diameter of 5-9mm is recommended.

Cable Entry/Plug: One cable entry (1/2" NPT with adapter, M20x1.5)

Accuracy Charts

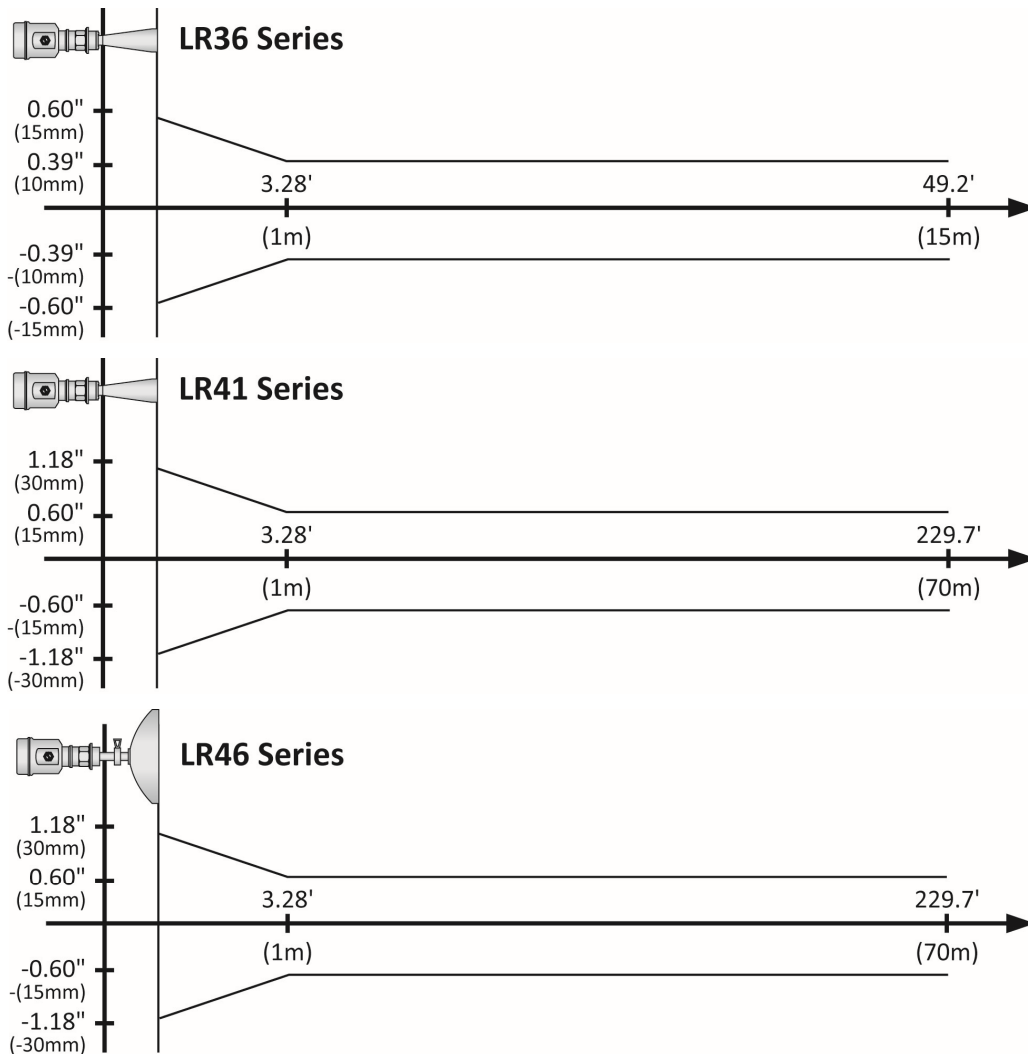

Communication: FCC (US)  
 Part 15.256, Class B: LR36 (4" horn), LR41 (4" horn) & LR46 (8", 10" parabolic) series can be installed on any tank material.

Compliance: The equipment complies with the following standards:

- IEC: 60079-0:2011 & 60079-11:2011
- EN: 60079-0:2012 & 60079-11:2012
- RoHS

This product is an intrinsically safe version (Ex ia IIC T6...T3 Ga) with stainless steel housing. All electric circuits are fully encapsulated in the internal enclosure, where no conductive parts will contact with flammable gas. Two-Wire system in service, the power of the product is from safety barrier limited at:

<b>U<sub>i</sub> = 26.4V</b>	<b>I<sub>i</sub> = 114mA</b>	<b>P<sub>i</sub> = 0.752W</b>	<b>C<sub>i</sub> = 0</b>	<b>L<sub>i</sub> = 51μH</b>
------------------------------	------------------------------	-------------------------------	--------------------------	-----------------------------

A safety barrier should be placed between power source and instrument for intrinsically safe version. All connection cables must be screened with maximum length of 500m (stray capacitor ≤ 0.1 μF/Km and stray inductance ≤ 1mH/Km). The level measurement instrument must be connected to ground potential and unapproved supplemental devices are not allowed to use.

Application conditions:

Temp. class	Maximum process temperature			
	T6	T5	T4	T3
Ta (max.)				
60 °C	60°C	95°C	130°C	180°C
65 °C	-----	70°C	130°C	180°C
70 °C	-----	70°C	130°C	180°C
85 °C	-----	-----	130°C	180°C

Pressure for electronic housing 11.5 psi (80kPa) to 16.0 (110kPa).

Ambient temperature: T6: -20°C ≤ Ta ≤ 60°C

T5: -20°C ≤ Ta ≤ 70°C

T4: -20°C ≤ Ta ≤ 85°C

T3: -20°C ≤ Ta ≤ 85°C

Cable Connection:

- This product shall be used with certified IECEx and ATEX cable glands and block plugs. The cable used for "ia" terminal shall be in compliance with the requirement of EN/IEC 60071-14 clause. Additional requirements for types of protection "I" – intrinsic safety. It's installing and operation instructions should be observed if other cable glands are used.
- Care should be taken with the cable glands which should be matched to the cable used outside diameter property; see mark of cable gland for the outer diameter of being cable used.
- In order to ensure the required minimum degree of protection, the bolts of cable glands, blanking plug and relevant sealing bolts are to be tighten down.

**INTRINSICALLY SAFE CONTROL DRAWING 301901**

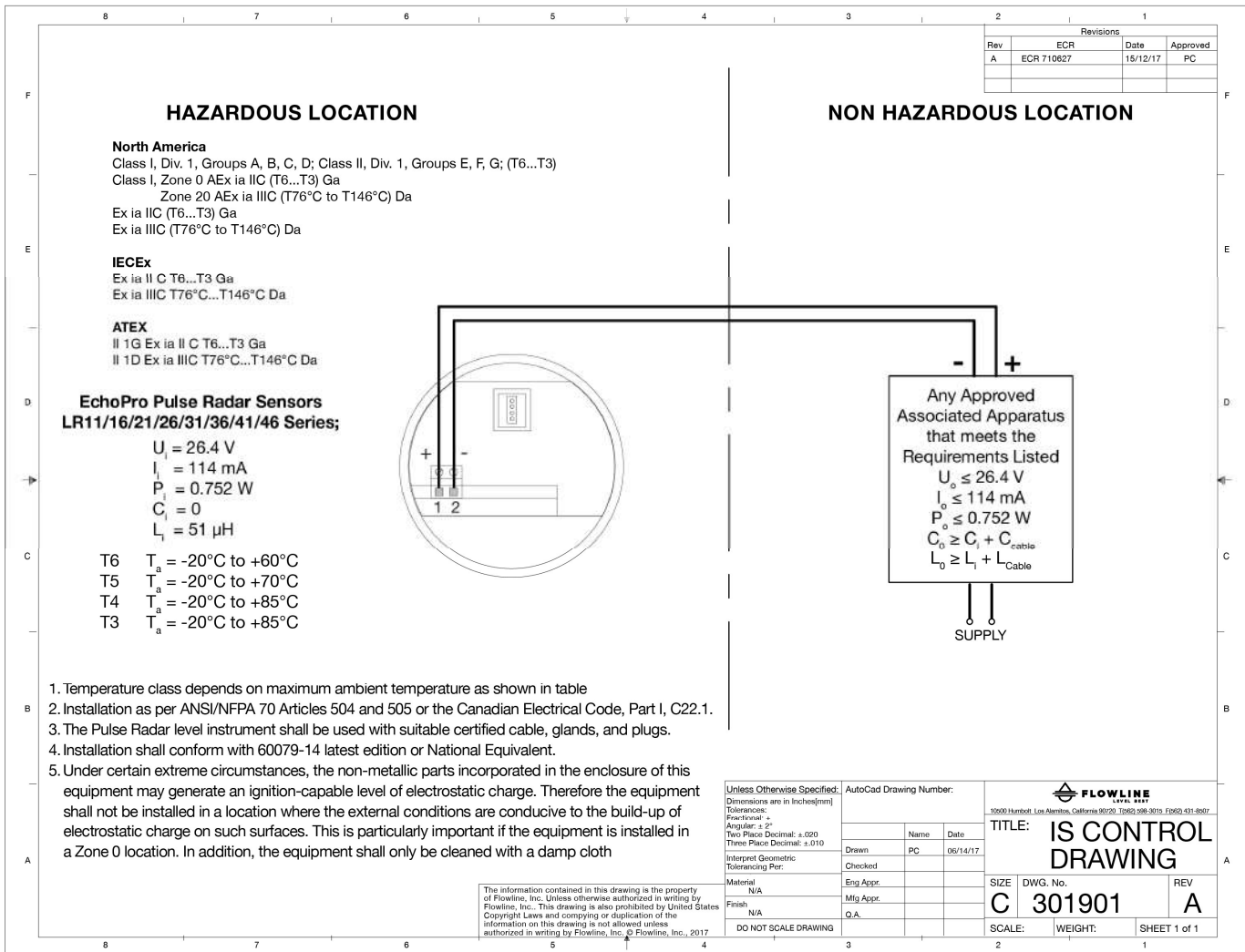

**Intrinsically Safe Approvals:**

**Intrinsic Safe:**

**North America:** Class I, Div.1, Groups A, B, C, D; Class II, Div.1, Groups E, F, G; (T6...T3)  
 (cCSA<sub>US</sub>) Class I, Zone 0 AEx ia IIC (T6...T3) Ga  
 Zone 20 AEx ia IIIC (T76°C to T146°C) Da

Ex ia IIC (T6...T3) Ga  
 Ex ia IIIC (T76°C to T146°C) Da

**ATEX:** II 1G Ex ia II C T6...T3 Ga;  
 (TUV) II 1D Ex ia IIIC T76°C...T146°C







**IECEX:** Ex ia II C T6...T3 Ga;  
 (TUV) Ex ia III C T76°C...T146°C Da

**General:** CE, RoHS

**Intrinsically Safe Entity Parameters:**

$U_i = 26.4\text{V};$        $I_i = 114 \text{ mA};$        $P_i = 0.752\text{W};$        $C_i = 0;$        $L_i = 51 \mu\text{H}$

**LABELS FOR INTRINSIC SAFETY**

 <p>Equipment: EchoPro™ Radar Level Instrument                  Type: LRXX-XXXX-XX                  Ex Marking:  II 1G Ex ia II C T6...T3 Ga   II 1D Ex ia III C T76°C...T146°C Da                  Ex ia II C T6...T3 Ga                  Ex ia III C T76°C...T146°C Da                  Class I, Div 1, Groups A, B, C &amp; D;                  Class II, Groups E, F &amp; G;                  Class I, Zone 0 IIC &amp; Zone 20 Group IIC</p> <p>Explosion Certificate: TÜV 16 ATEX 7834 X                  IECEx TUR. 16.0014X</p> <p>Ui = 26.4V li = 114mA Pi = 0.752W Ci = 0 Li = 51uH                  Output: (4...20) mA HART two-wire                  Ambient Temperature: See manual and instructions                  WARNING POTENTIAL ELECTROSTATIC CHARGING HAZARD:                  SEE INSTRUCTIONS</p>   0035			This device complies with Part 15 of the FCC Rules. Operation is subject to the following two conditions: (1) this device may not cause harmful interference, and (2) this device must accept any interference received, including interference that may cause undesired operation FCC ID: 2ACQELRZZ
Address: Flowline Inc. 10500 Humbolt Street Los Alamitos, CA 90720			

Part Number Label

P/N	LRXX-XXXX
S/N	YYMMDD-000000

**DIMENSIONS**

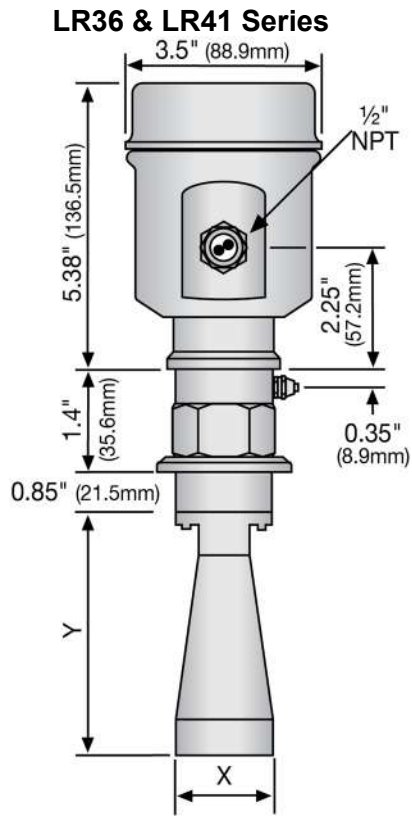

**LR36 & LR41 Threaded Series  
Antenna Dimensions**

Diameter (X)	Length (Y)
4" (98mm)	11.34" (288mm)

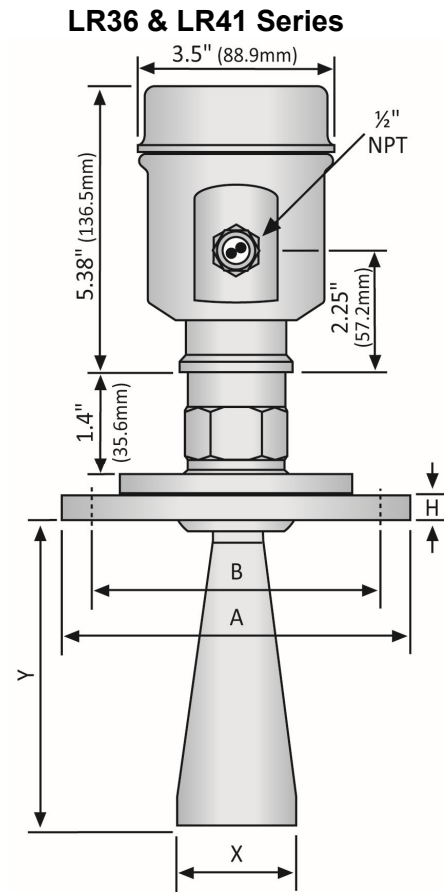

**LR36 & LR41 Flange Series  
Antenna Dimensions**

Flange	Diameter (A)	Diameter (B)	Thickness (H)
4" ANSI	9.0" (228.6mm)	7.09" (190.5mm)	0.4" (10.2mm)

Hole Diameter = 0.75" (19.1mm) x 8

**LR36 & LR41 Threaded Series  
Antenna Dimensions**

Diameter (X)	Length (Y)
4" (98mm)	11.34" (288mm)

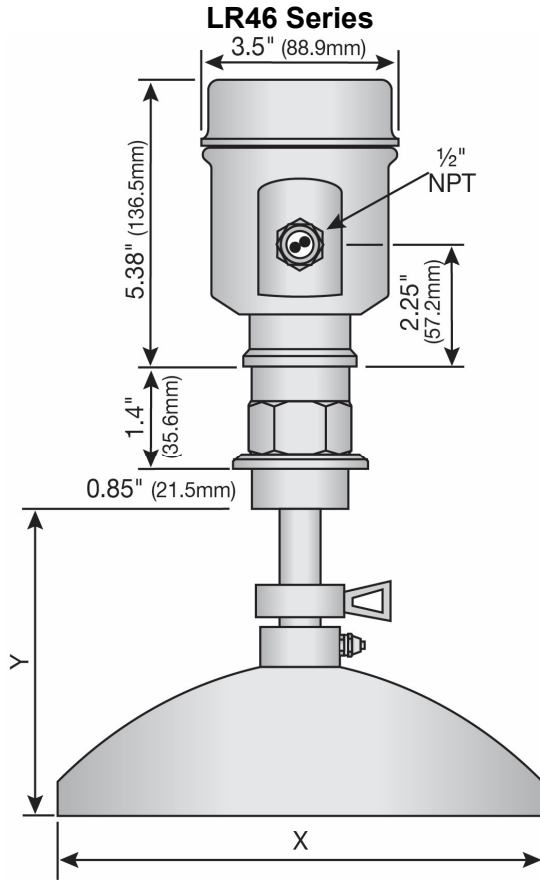

**LR46 Threaded Parabolic Series  
Antenna Dimensions**

Diameter (X)	Length (Y)
7.8" (198mm)	5.55" (141mm)
9.7" (246mm)	5.55" (141mm)

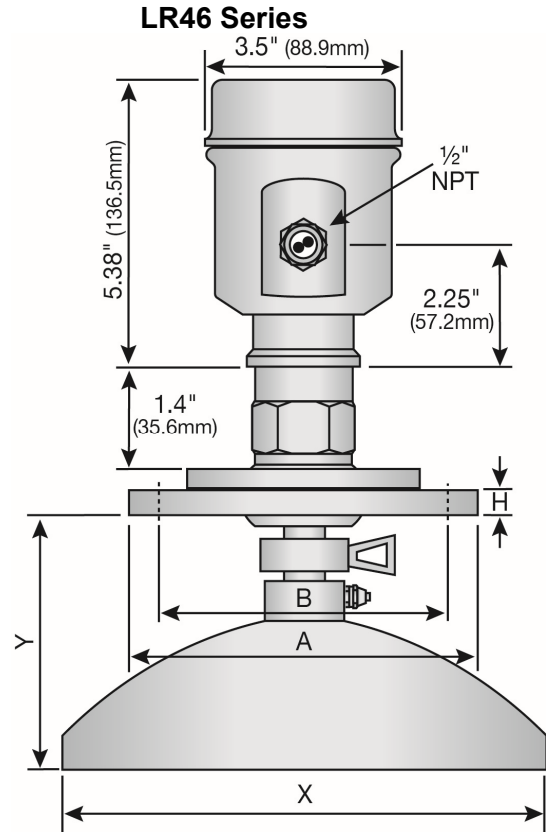

**LR46 Flange Parabolic Series  
Antenna Dimensions**

Flange	Diameter (A)	Diameter (B)	Thickness (H)	Hole Pattern
4" ANSI	9.0" (228.6mm)	7.5" (190.5mm)	0.40" (10.2mm)	8 x 19.1mm
8" ANSI	13.4" (340mm)	11.6" (295mm)	0.45" (11.5mm)	12 x 22mm
10" ANSI	15.9" (405mm)	14.0" (355mm)	0.45" (11.5mm)	12 x 26mm

**LR46 Threaded Parabolic Series  
Antenna Dimensions**

Diameter (X)	Length (Y)
7.8" (198mm)	4.53" (115mm)
9.7" (246mm)	4.53" (115mm)

---

**SAFETY PRECAUTIONS**

**⚠ About this Manual:** PLEASE READ THE ENTIRE MANUAL PRIOR TO INSTALLING OR USING THIS PRODUCT. This manual includes information on the EchoPro® Radar Level Transmitter from FLOWLINE. Please refer to the part number located on the sensor label to verify the exact model, which you have purchased.

**⚠ User's Responsibility for Safety:** Flowline manufactures a broad range of level sensing technologies. While each of these sensors is designed to operate in a wide variety of applications, it is the user's responsibility to select a sensor model that is appropriate for the application, install it properly, perform tests of the installed system, and maintain all components. The failure to do so could result in property damage or serious injury.

**⚠ Proper Installation and Handling:** Only professional staff should install and/or repair this product. Never over tighten the sensor within the fitting. Always check for leaks prior to system start-up.

**⚠ Wiring and Electrical:** A supply voltage of 21.6 to 26.4 VDC is used to power the EchoPro®. Electrical wiring of the sensor should be performed in accordance with all applicable national, state, and local codes.

**⚠ Material Compatibility:** The enclosure is made of either Aluminum or 316 Stainless Steel (refer to sensor part number). The antenna is made of Stainless Steel (SS), Polytetrafluoroethylene (PTFE), Polyvinylidene Fluoride (PVDF) or Nylon (PA66) with a Viton seal (refer to sensor part number). Make sure that the model, which you have selected, is chemically compatible with the application media.

**⚠ Enclosure:** The sensor housing is media-resistant, but is not designed to be operational when immersed. Mount the sensor in such a way that the enclosure and antenna do not come into contact with the application media under normal operational conditions. The enclosure has a cover that provides access to the push button display module and terminal strip for wiring. To open the enclosure, you will need to twist the cover counter-clockwise. Before closing the enclosure, make sure that the enclosure gasket is properly seated, and that any conduit fittings, cable connectors or plugs are installed correctly and sealed. **Note:** *If using the Flowline LM90-1001 (liquid tight fitting) on the ½" conduit, the cable minimum is 0.170" (4.3mm) and the maximum is 0.450" (11.4mm).*

**⚠ Make a Fail-Safe System:** Design a fail-safe system that accommodates the possibility of sensor and/or power failure. FLOWLINE recommends the use of redundant back-up systems and alarms in addition to the primary system.

**⚠ Flammable, Explosive or Hazardous Applications:** *EchoPro® is approved for use within intrinsically safe applications ONLY and should NOT be used within classified hazardous environments.*

**⚠ Handling Static-Sensitive Circuits and Devices:** When handling the instrument, the technician should follow the below guidelines to reduce the possibility of an electrostatic charge build-up on the technician's body from being transferred to the electronic part. Always touch a known good ground source before handling a part. This should be repeated while handling the part and more frequently after sitting down from a standing position, sliding across the seat or walking a distance. Avoid touching electrical terminals of the part unless making connections. DO NOT open the unit cover until it is time to work on the part.

---

**SETUP OVERVIEW**

The below highlights the initial steps in setting up your sensor for operation.

**1. Part Number (Section Two)**

1. Prior to purchasing the sensor, you may have submitted a Level Application Questionnaire ([www.flowline.com/LAQ](http://www.flowline.com/LAQ)), which based upon the information provided, may have resulted in a suggested part number. Where so, confirm that the suggested part number matches the part number of the purchased sensor. If any of the above does not match and/or meet your application requirements, please contact your distributor.

**2. Install Sensor (Section Three)**

1. Information on the location and mechanical installation of the sensor.

**3. Wire Sensor (Section Four)**

1. Information on the electrical wiring and power requirements of the sensor.

**4. Basic Configuration (Section Five)**

1. Begin by measuring the tank for all key dimensions.
  - a. Accuracy in measurement will result in accuracy of sensor performance.
2. Set the Units of Measurement for the sensor.
  - a. Units can be configured in basic engineering units of length: Feet, Meters
3. Set the Sensor Height for the sensor in the tank.
  - a. This is the 4mA setting for the output.
4. Set the Fill-Height for the sensor in the tank.
  - a. This is the 20mA setting for the output.
5. Set the Max. Range (Maximum Range or MaxR) for the sensor in the tank.
  - a. The sensor will ignore any echo signal returns beyond this setting.
6. Set the Dead Band (Minimum Range or MinR) for the sensor in the tank.
  - a. The sensor will ignore any echo signal returns closer than this setting.
7. Check the Echo Curve
  - a. This is a quick check to determine if the sensor is reading the correct level.

**5. Process Adjustments (Section Six)**

1. Information on OPTIONAL adjustments for specific process conditions that may exist in your application.
  - a. Fast filling or emptying of media.
  - b. Media surface is turbulent or agitated.
  - c. Foam on the surface of the media.
  - d. Sensor installed in a still well or sight glass.
  - e. Powder or Dust is present.
  - f. Low Dielectric material
  - g. Large Angle of Repose with the material

**6. Advanced Adjustments (Section Seven)**

1. Reverse 4-20 mA Output
  - a. Reverses the current output from 4mA @ bottom and 20mA @ top of tank to 20mA @ bottom and 4mA @ top of the tank.
2. Fail-Safe Setting
  - a. Allows for the presetting of the current output when a sensor failure occurs.
3. Minimum Current Setting
  - a. Sets the minimum current output for the sensor.
4. Create a New False Echo Curve
  - a. A method to map out false echo signal returns within the tank.
5. Update an Existing False Echo Curve
  - a. A method to update false echo signal returns for a section of the tank that was not exposed during the creation of the original False Echo Curve.

**7. Troubleshooting (Section Eight)**

1. Measurement Status
  - a. Determines the measurement reliability and general status of the sensor.
2. Peak Values
  - a. Displays the lowest and highest level height that the sensor has measured in distance (d).
3. Simulation
  - a. Simulates and helps to determine the accuracy and linearity of the sensor.
4. First Echo Adjustment
  - a. Increases or decreases the strength of the first echo signal return.
5. Echo Curve Zoom In
  - a. A method to zoom in and view the Echo Curve over a specific range.
6. False Echo Curve Delete
  - a. A method to delete a previously saved False Echo Curve from memory.
7. Reset
  - a. A method to reset the sensor's configuration to the original factory setting.

**PART NUMBER**

Prior to purchasing the sensor, you may have submitted a Level Application Questionnaire ([www.flowline.com/LAQ](http://www.flowline.com/LAQ)). Based upon the information provided, it may have resulted in a suggested part number. Where so, confirm that the suggested part number matches the part number of the sensor. The part number can be found on the outside label of the sensor as shown below:



The part number will indicate the size and type of mounting fitting required for installing the sensor. Refer to the below part number description for specific information. If any of the above does not match and/or meet your application requirements, please contact your distributor.

LR36 - 5  2 1 - 4  - 0 0

**Housing Material**

5 - Stainless Steel

**Process Connection**

0 - Thread 1 1/2" NPT

3 - ANSI Flange

**Approval**

2 - ATEX / IECEx / HazLoc

**Output**

1 - Approval

**Antenna Shape**

4 - 4" (98mm) Horn

**Flange Size**

0 - Threaded Connection

4 - 4" Gimbaled Flange

LR41 - 5  2 1 -   - 0 0**Housing Material**

5 - Stainless Steel

**Process Connection**

0 - Thread 1 ½" NPT

3 - ANSI Flange

**Approval**

2 - ATEX / IECEx / HazLoc

**Output**

1 - 4-20 mA

**Antenna Shape**

4 - 4" (98mm) Horn

A - 4" (98mm) Horn (PTFE Cover)

**Flange Size**

0 - Threaded Connection

4 - 4" Gimbaled Flange

LR46 - 5 3 2 1 -  4 - 0**Housing Material**

5 - Stainless Steel

**Process Connection**

3 - ANSI Flange

**Approval**

2 - ATEX / IECEx / HazLoc

**Output**

1 - 4-20 mA

**Antenna Shape**

8 - 8" (196mm) Parabolic

0 - 10" (246mm) Parabolic

**Flange Size**

4 - 4" Gimbaled Flange

### INSTALLATION REQUIREMENTS

EchoPro® measures the distance between the sensor and the media surface below. Typically, all measurements from the sensor originate from the bottom of the antenna. Refer to the Measurement Reference Chart to determine the location where measurement originates on your sensor. To ensure reliable measurement, adhere to the following minimum installation requirements:

- 1) There are no obstructions between the bottom edge of the installed antenna and the surface of the media below including ladders, walls, tank seams, media inflows, rails, other sensors, mixer blades, heating coils, pumps, struts or apparatus. **Note:** *Additionally, when the sensor transmits a microwave pulse, the RF signal spreads in a conical shape (determined by its beam angle) over distance.* Refer to the Beam Angle Chart to determine, what if any, additional measurement space is required to be free of such obstacles. If such items are present, then a False Echo Curve configuration must be conducted (Section Seven).
- 2) The sensor must be installed with the antenna perpendicular to the surface of the media.
- 3) The sensor must be installed with a distance  $\geq 19.7"$  (500mm) from the side wall of the tank.
- 4) The media level must not be allowed to enter into the dead band (blanking zone) of the sensor.
- 5) The sensor installation must be done in accordance with relevant local or federal safety regulations.
- 6) The sensor must be connected to electrical ground.
- 7) Do not use the housing to screw the sensor into the installation fitting (LR36 & LR41 Series).
  - a) Applying force against the housing to tighten may damage the sensor.
- 8) Make sure that any part of the sensor as exposed to the application, specifically any portion installed within the tank, are suitable for the process.
  - a) Consider any effects from the application temperature, pressure or media.

### AIR PURGING (LR41 & LR46 SERIES ONLY)

An air purge connection can be used to prevent clogging of the antenna in applications with significant dust. If significant dust is present in the application, then connect the integrated air purge connection to an air line. The air purge is included with the LR41 & LR46 series only. **Note:** the air purge is not included with LR41 series with dust shield or with the LR36 series.

5-10 psig is adequate for continuous air delivery. The orifice size of the three holes in the horn antenna will limit air flow to about 2 CFM.

**LR41 series w/  
Flange**

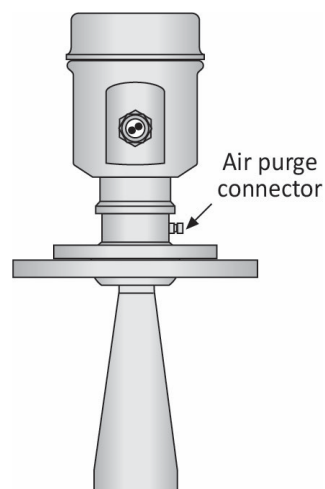

**LR41 series w/  
Threads**

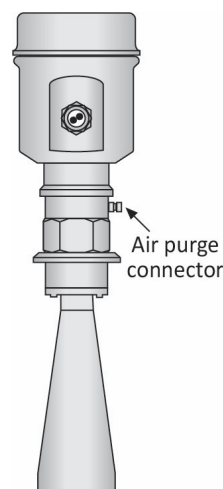

**LR46 series**

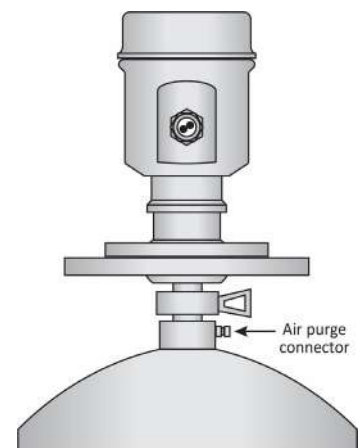

**FCC CONFORMITY**

- ⚠ This instrument complies with Part 15 of the FCC Rules. Operation is subject to the following two conditions: (1) this instrument may not cause harmful interference, and; (2) this instrument must accept any interference received, including interference that may cause undesired operation.
- ⚠ Changes or modifications not expressly approved by the manufacturer could void the user's authority to operate the equipment.
- ⚠ **Warning:** User must maintain a safe zone distance of at least 20cm (7.87") from the antenna.
- ⚠ **NOTE: LR36 (4" horn), LR41 (4" horn) & LR46 (8" and 10" parabolic) series:** This equipment has been tested and found to comply with the limits for a Class B digital device, pursuant to Part 15 of the FCC Rules. These limits are designed to provide reasonable protection against harmful interference in a residential installation. This equipment generates uses and can radiate radio frequency energy and, if not installed and used in accordance with the instructions, may cause harmful interference to radio communications. However, there is no guarantee that interference to radio and television reception, which can be determined by turning the equipment off and on, the user is encouraged to try to correct the interference by one or more of the following measures:
  - Reorient or relocate the receiving antenna.
  - Increase the separation between the equipment and the receiver.
  - Isolate the equipment to an outlet different from where the receiver is connected.
  - Consult the dealer or an experienced technician for help.

**LR36 & LR41 ANTENNA PREPARATION**

The LR36 and LR41 Series antenna (only) may be removed from the sensor to allow a flange or reducer bushing accessory to be attached to the 1 1/2" NPT mounting threads and/or, the antenna may be inserted from within the inside of the tank through the bottom of an existing fitting (where the base of the antenna is too wide to pass through the fitting from the top). Referencing the illustrations, follow the below steps to disconnect, mount and reattach the antenna.

- 1) Loosen and remove the four (4) socket screws using a 3mm Allen wrench.
- 2) Carefully remove the antenna. **Note:** Do not remove or damage the plastic cone (microwave RF emitter) within the antenna socket.
- 3) Insert the antenna through the bottom of the fitting. **Note:** If doing so from the inside of the tank, make sure to secure it, so as to prevent the antenna from falling into the tank.
- 4) Connect the sensor to the antenna socket and reattach the four (4) screws using a 3mm Allen wrench.
- 5) Attach the sensor to the fitting as necessary.

**Add a Flange**

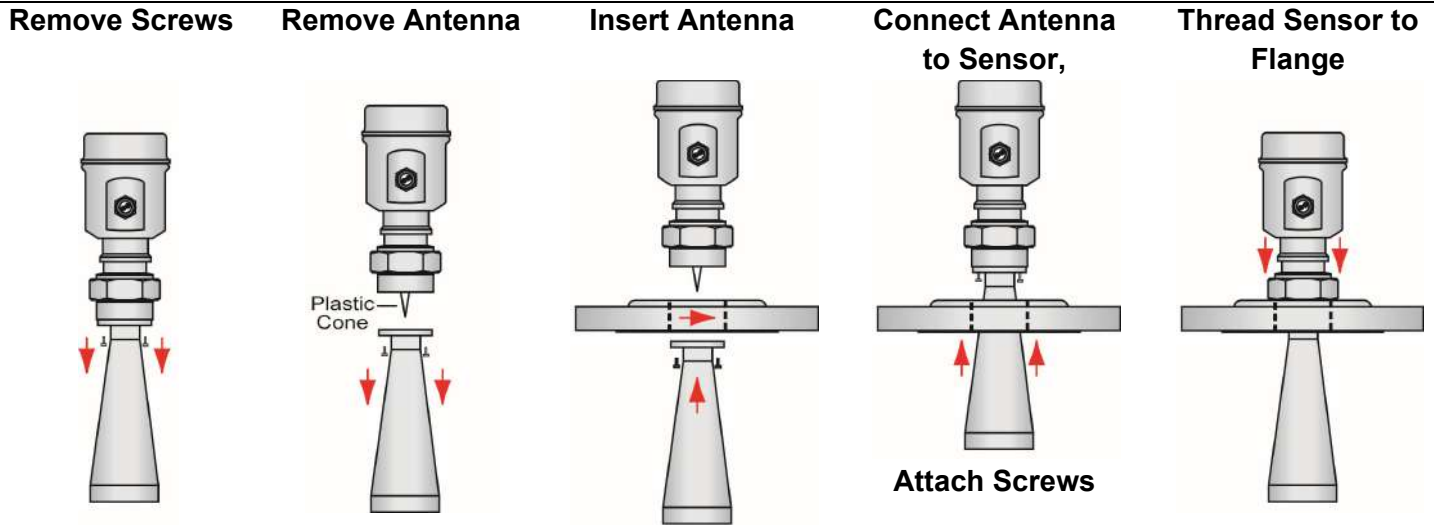

**Add a Reducer Bushing**

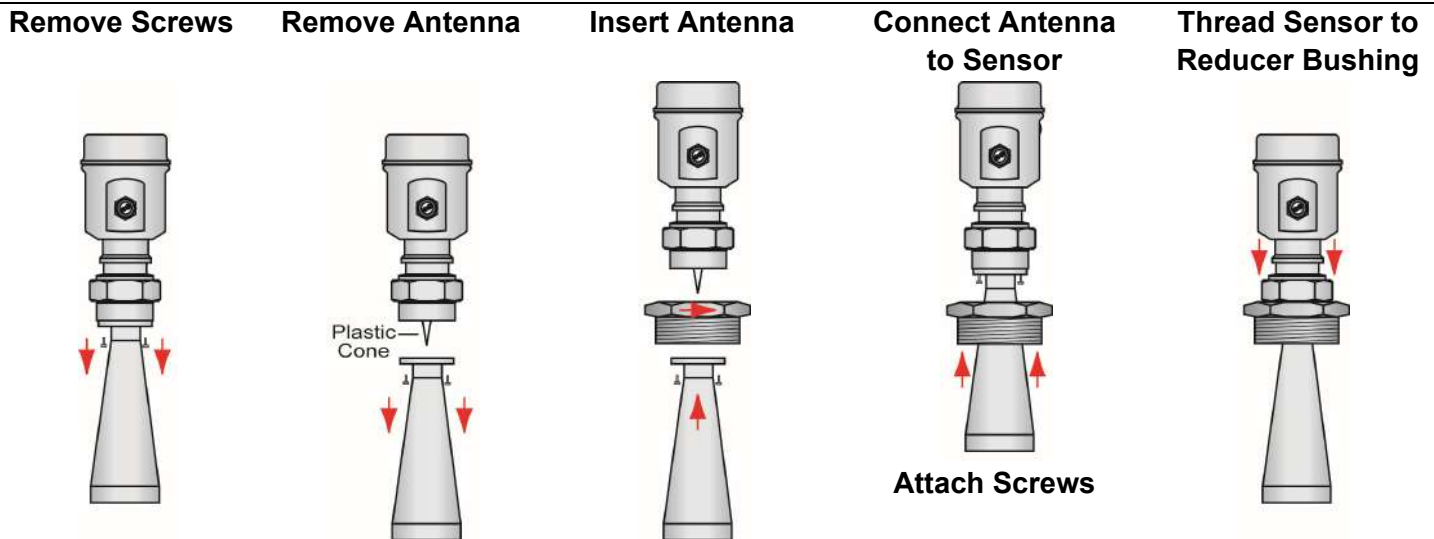

**LR46 PARABOLIC ANTENNA PREPARATION**

The LR46 Series parabolic antenna (only) may be removed from the sensor to allow a flange or reducer bushing accessory being attached to the 1 1/2" NPT mounting threads and/or, the antenna may be inserted from within the inside of the tank through the bottom of an existing fitting (where the base of the antenna is too wide to pass through the fitting from the top). Referencing the illustrations, follow the below steps to disconnect, mount and reattach the antenna.

- 1) Loosen and remove the tri-clamp connector.
- 2) Carefully remove the antenna.
- 3) Insert the antenna through the bottom of the flange. **Note:** If doing so from the inside of the tank, make sure to secure it, so as to prevent the parabolic antenna from falling into the tank.
- 4) Connect the sensor to the parabolic antenna socket and reattach the tri-clamp connector.
- 5) Attach the sensor to the fitting as necessary.

**Add a Flange to the Parabolic Antenna**

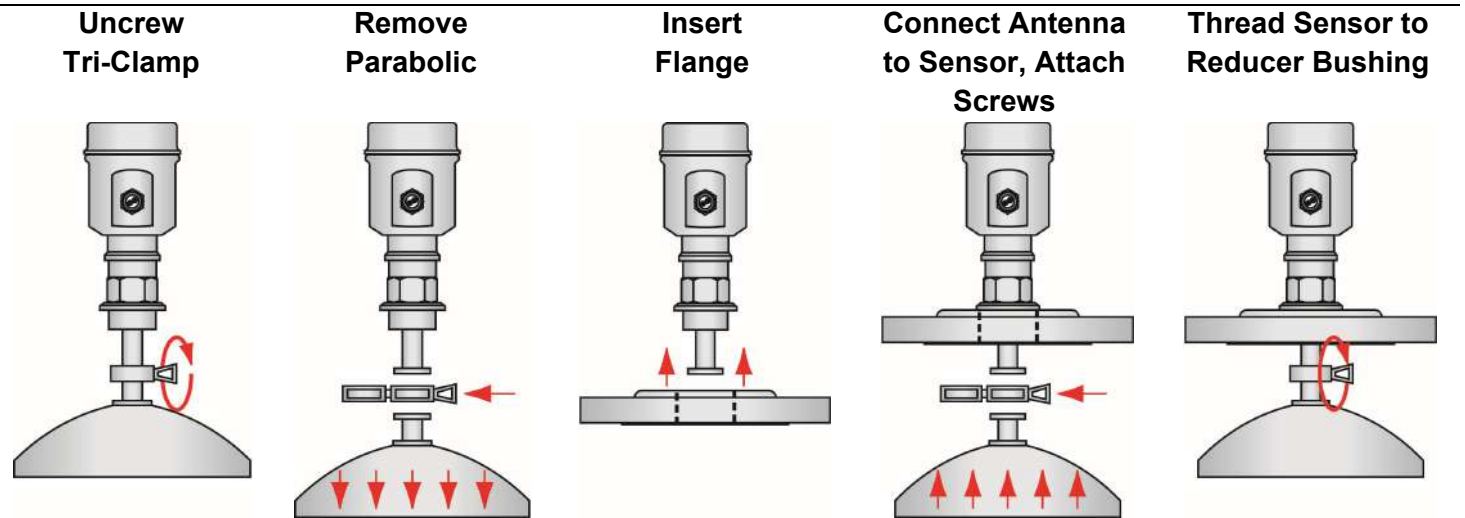

**FLANGE RISER INSTALLATION**

When installing the sensor on a flange with a riser (or any fitting that is tall and narrow), the antenna must protrude at least 0.4" (10mm) from the bottom of the riser.

**Antenna Extension**

**LR46 Series Shown**

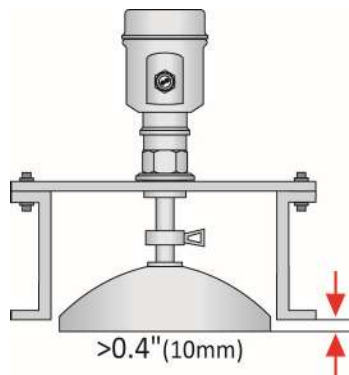

The sensor can be installed within the riser as long as the media has a strong reflective property (dielectric constant) providing a strong echo return. The below information describes the maximum distance that the antenna can be recessed within a riser based on the diameter and height of the fitting.

**BEAM ANGLE**

The emitted microwave pulse will expand along its specified beam angle for the entire height of the tank. Place the sensor so that objects will not interfere with the beam path underneath the sensor. The beam angle is a function of the sensor Series and antenna length (where variable). Verify the beam angle specification of your sensor and reference the below charts to determine the amount of free measurement space required under the installed sensor.

Beam Angle	4°	5°	6°	8°	12°
Height	Diameter				
10'	0.70'	0.87'	1.05'	1.40'	2.10'
20'	1.40'	1.75'	2.10'	2.80'	4.20'
30'	2.10'	2.62'	3.14'	4.20'	6.31'
40'	2.79'	3.49'	4.19'	5.59'	8.41'
50'	3.49'	4.37'	5.24'	6.99'	10.51'
60'	4.19'	5.24'	6.29'	8.39'	12.61'
70'	4.89'	6.11'	7.34'	9.79'	14.71'
80'	5.59'	6.99'	8.39'	11.19'	16.82'
90'	6.29'	7.86'	9.43'	12.59'	18.92'
100'	6.98'	8.73'	10.48'	13.99'	21.02'

Beam Angle	4°	5°	6°	8°	12°
Height	Diameter				
5m	0.35m	0.44m	0.52m	0.70m	1.05m
10m	0.70m	0.87m	1.05m	1.40m	2.10m
15m	1.05m	1.31m	1.57m	2.10m	3.15m
20m	1.40m	1.75m	2.10m	2.38m	4.20m
25m	1.75m	2.18m	2.62m	3.50m	5.26m
30m	2.10m	2.62m	3.14m	4.20m	6.31m

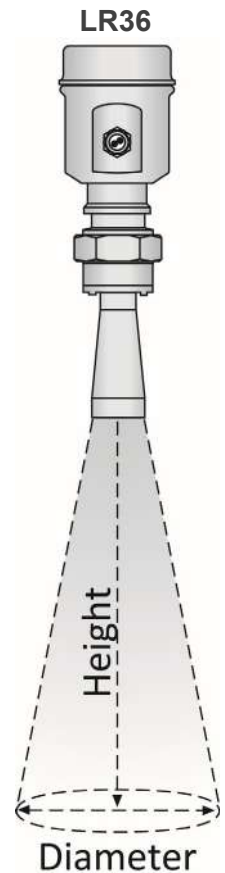

**AVOID CONDENSATION IN THE CONDUIT**

You can give your instrument additional protection against moisture penetration by leading the conduit connection or cable downward in front of the cable entry. Condensation in the conduit will therefore not enter the sensor's enclosure.

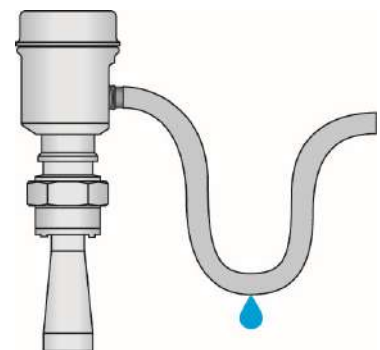

**GIMBAL MOUNTS (FOR SOLIDS)**

Be aware of antenna's length and width when using a gimbaled mount. The freedom of movement for the gimbaled becomes less as the riser's height increases.

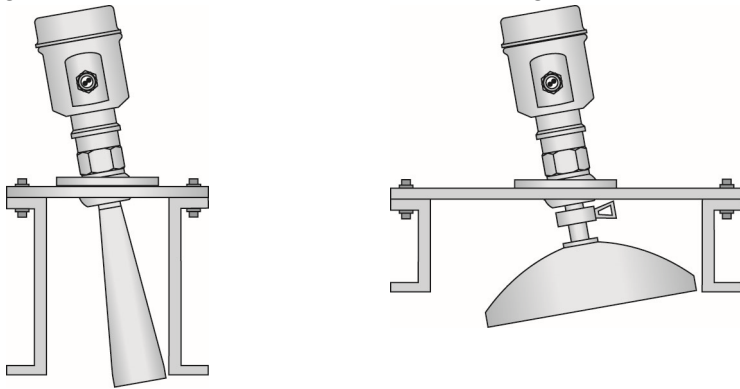

**SOLIDS INSTALLATION TIPS**

In order to measure as much of the solids volume as possible, the antenna must be aimed at the lowest point within the tank. With any cylindrical shaped tank with a cone bottom, the sensor should be mounted a distance of half the radius ( $\frac{1}{2}R$ ) from the side wall. If  $\frac{1}{2}R$  cannot be met, it is preferred to mount the sensor closer to the side wall and away from the center of the tank.

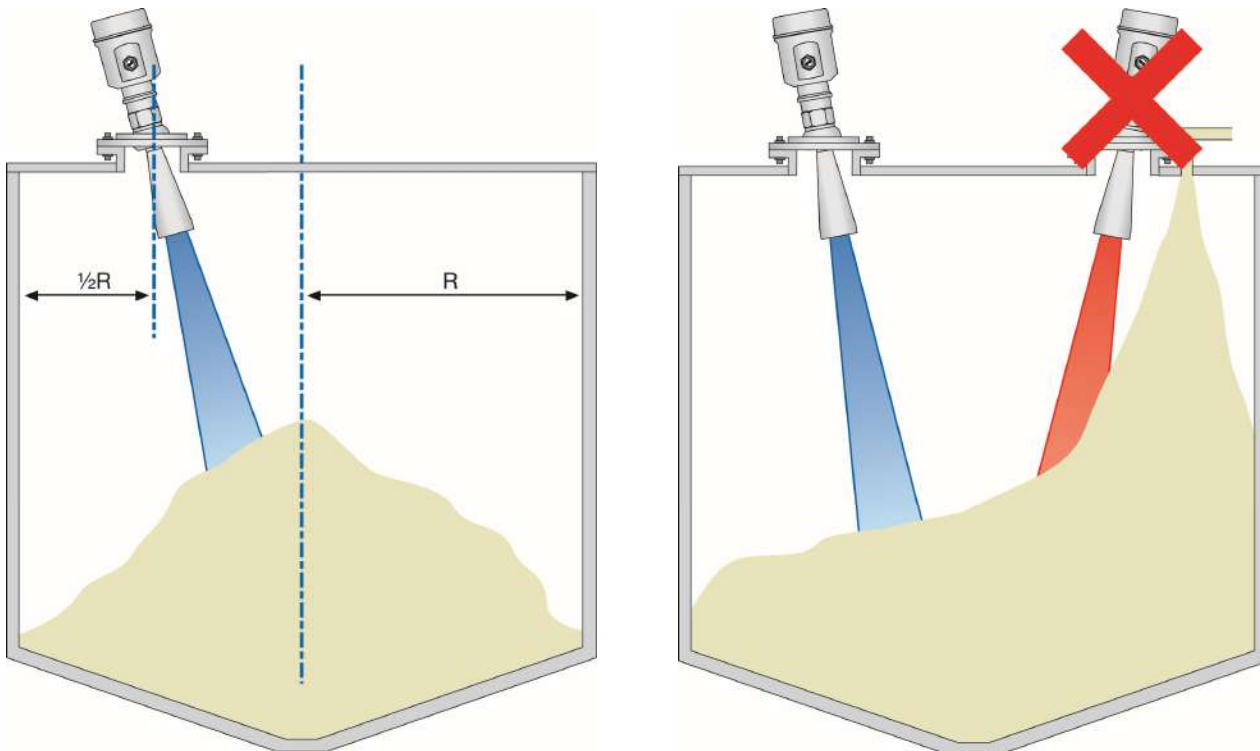

Avoid installing the sensor above the filling stream to avoid interference to the radar pulse. Locate the sensor away from the filling stream.

**SOLIDS INSTALLATION TIPS (CONTINUED)**

When using the gimbaled flange, the sensor can easily be mounted to direct the signal energy towards center of the tank. The angle of the sensor will be dependent on the distance down to the bottom of the tank and the distance away from the bottom of the cone. Use the chart below to understand the angle required to direct the signal to the bottom of the cone.

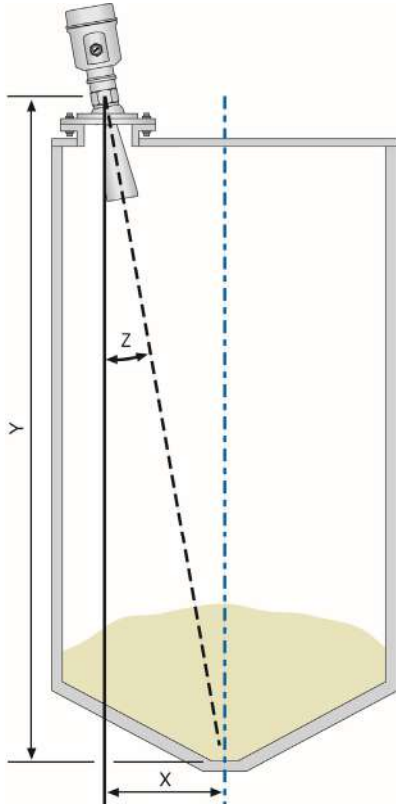

Distance (Y)	2° (Z)	4° (Z)	6° (Z)	8° (Z)	10° (Z)
10'	0.35'	0.70'	1.05'	1.41'	1.76'
20'	0.70'	1.40'	2.10'	2.81'	3.53'
30'	1.05'	2.10'	3.15'	4.22'	5.29'
<b>40'</b>	<b>1.40'</b>	<b>2.80'</b>	<b>4.20'</b>	<b>5.62'</b>	<b>7.05'</b>
50'	1.75'	3.50'	5.26'	7.03'	8.82'
60'	2.10'	4.20'	6.31'	8.43'	10.58'
70'	2.44'	4.89'	7.26'	9.84'	12.34'
80'	2.79'	5.59'	8.41'	11.24'	14.11'
90'	3.14'	6.29'	9.46'	12.65'	15.87'
100'	3.49'	6.99'	10.51'	14.05'	17.63'

**Distance from Cone Bottom (X)**

Distance (Y)	2° (Z)	4° (Z)	6° (Z)	8° (Z)	10° (Z)
5m	0.17m	.35m	0.53m	0.70m	0.88m
10m	0.35m	0.70m	1.05m	1.41m	1.76m
15m	0.52m	1.05m	1.58m	2.11m	2.65m
20m	0.70m	1.40m	2.10m	2.81m	3.53m
25m	0.87m	1.75m	2.63m	3.51m	4.41m
30m	1.05m	2.10m	3.15m	4.22m	5.29m

**Distance from Cone Bottom (X)**

**EXAMPLE:**

If the EchoPro® is 40' (Y-distance) above the bottom of the cone and the transmitter is 7.0' (X-distance) from the Center-line of the cone bottom, then the transmitter will be angled 10° (Z-angle) off-center.

Most Smart Phones have a built-in Spirit Level which will show the angle of the sensor. Remove the Cap from the EchoPro® and activate the Spirit Level App or any equivalent App for your SmartPhone. Place the Smart Phone on the display of the transmitter and adjust the sensor to its required angle.

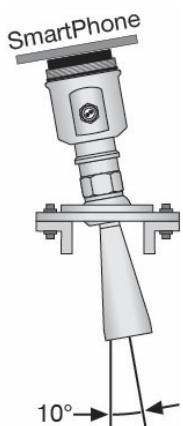

SmartPhone with Spirit Level

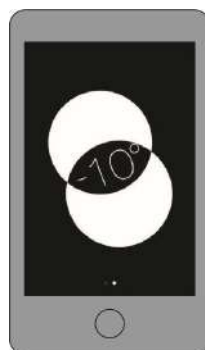

### REMOVE THE DISPLAY

To access the terminal strip and conduit ports, you must remove the display. Gently twist the display counter-clockwise until you feel the display unlock from the housing. Next, lift the display from the housing to view the terminal strip and wire access ports. **Note:** *This procedure applies to all sensors.*

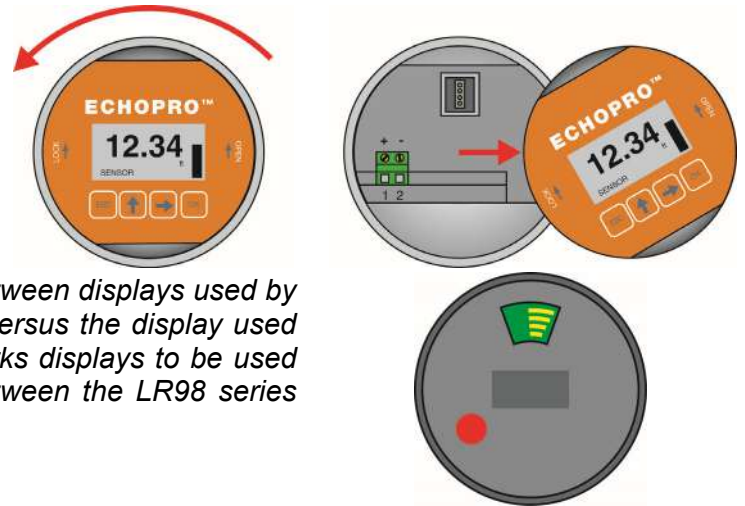

**Note:** *There is an internal configuration difference between displays used by the EchoPro® sensors (LR36, LR41 & LR46 series) versus the display used with the LR98 series. A colored dot on the back marks displays to be used only with the LR98 series. Never swap displays between the LR98 series and other EchoPro® sensors.*

### SUPPLY VOLTAGE

The sensor power supply and current signal share the same two-wire shielded cable. The sensor supply voltage should never exceed 26.4 VDC. Always provide complete electrical and physical separation between the sensor supply circuit and the main circuit. **Note:** *Remember that the output voltage of the power supply can be lower under nominal load (with a sensor current of 20.5 mA or 22 mA) and/or with the addition of other instruments placed within the circuit. If voltage spikes or surges are expected, adequate isolation protection must also be provided.*

### TERMINAL WIRING

The positive (+) and Negative (-) terminals are for connection to a 24 VDC power supply or to a 4-20 mA loop power source. The wire to the terminals can be extended up to 1,000 feet using 22 gauge or larger wire.

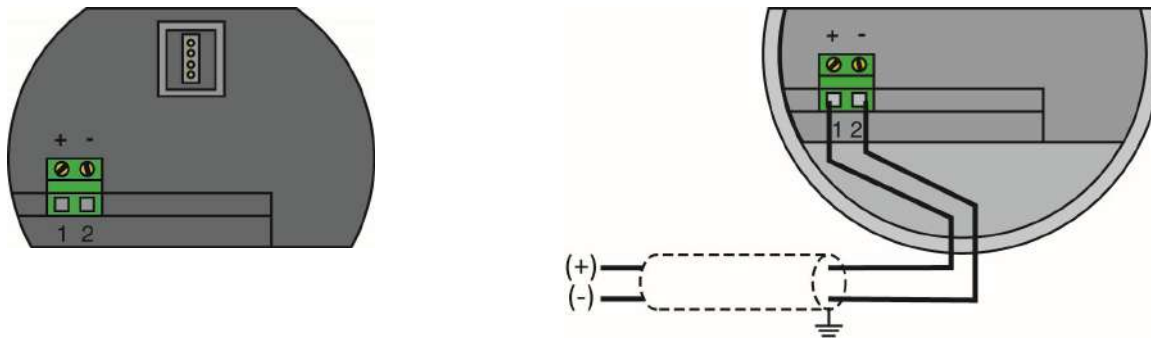

The sensor should be wired with shielded 2-conductor cable (16 to 22 AWG) to protect from electromagnetic interference. If using a liquid tight connector, select a cable with an outer diameter that is designed to ensure an effective seal with the connector [typically between 0.20" to 0.35" (5 to 9 mm)].

### ELECTRICAL, USAGE AND SAFETY

1. Wiring should always be done by a licensed electrician in accordance with national, state and local codes.
2. Where personal safety or significant property damage can occur due to a spill, the installation must have a redundant fail-safe backup system installed which accounts for sensor and/or power failure.

**HART® WIRING**

If a HART® communicator is used, place a 250 Ohm resistor between the sensor negative (-) and the power supply negative (-). Refer to the wiring diagram below as to the placement of the HART® communicator.

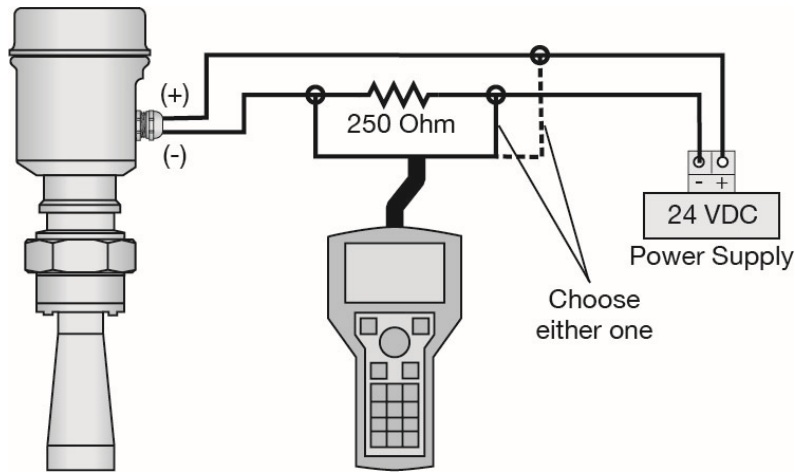

**HART® DEVICE DESCRIPTORS (DD FILES)**

**Note:** EchoPro® is HART 7.0 certified and can be configured using a HART communicator. The Device Descriptor (DD) files have been released on the Flowline website and can be installed onto your communicator. The files can be found on the individual EchoPro product pages. Simply click on your sensor from the EchoPro Liquid page (<https://www.flowline.com/echopro-solids-radar/>).

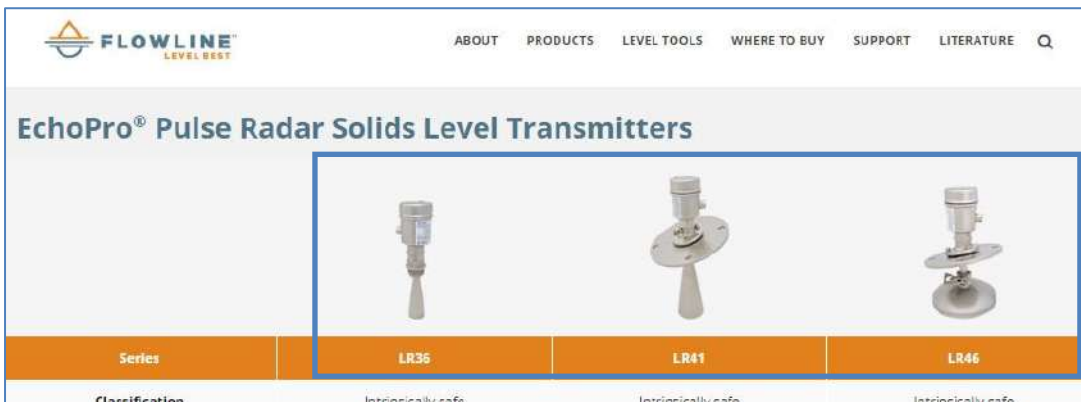

**STANDARD VS MULTIDROP**

HART® enables multiple HART® devices to share the same two wires. If using multiple HART® devices along the same loop, then each device must have a unique address. Use the Operational Mode (4.6) setting, page 70, to switch from Standard (Address of 00) to Multidrop. Within Multidrop, the address can be changed to a unique number between 1 and 15. Also, the current consumption of the sensor can be switched from the default of 4mA to 8mA. When in Multidrop, the sensor will output a constant current reading.

Operational mode	4.6
Standard	00
Multidrop	
Current	4mA

WIRING TO DISPLAYS, CONTROLLERS & PLC'S

Below are examples of how to wire EchoPro® to common displays, controllers and PLC's.

**DataView™ LI55 Series  
Level Controller**

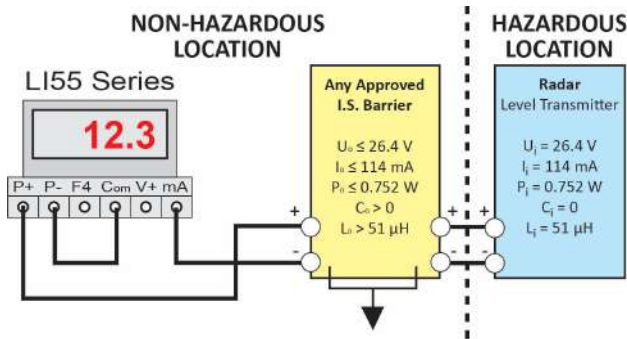

**Commander™ LI90 Series  
Multi-Tank Level Controller**

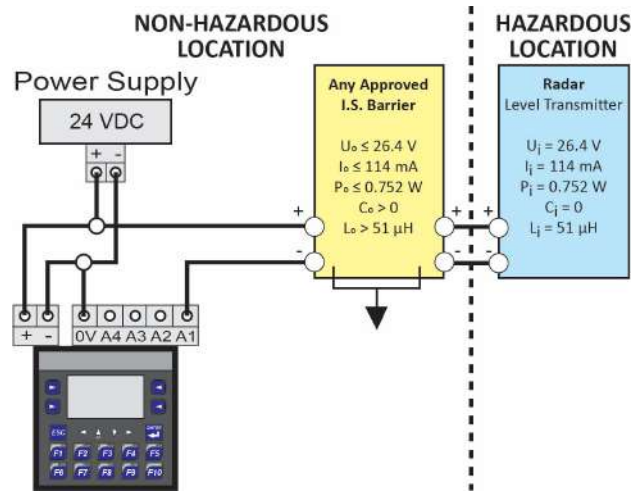

**Note:** Always refer to the Control Drawing 301901 for further wiring information.

**DataLoop™ LI23 Series  
Level Indicator  
(Without Backlight)**

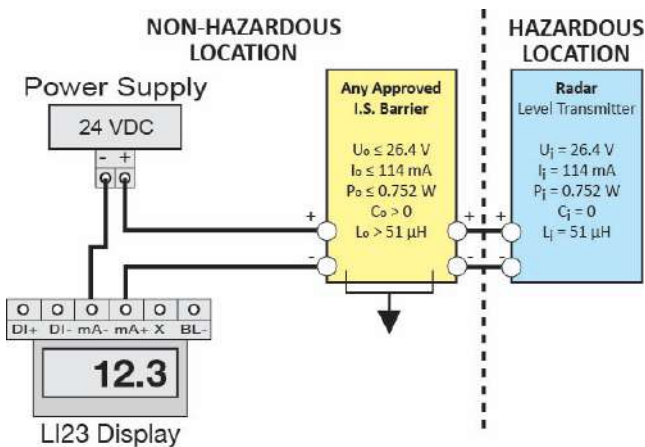

**DataLoop™ LI23 Series  
Level Indicator  
(With Backlight)**

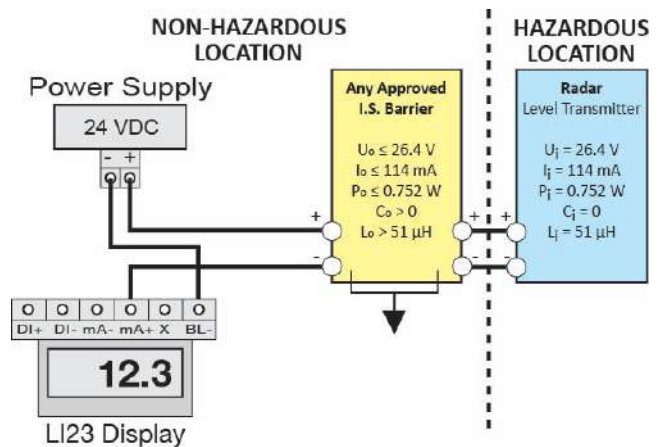

**Note:** Always refer to the Control Drawing 301901 for further wiring information.

WIRING TO DISPLAYS, CONTROLLERS & PLC'S

**DataPoint™ LC52 Series  
Level Controller  
(\*JWA Mode - Factory Setting)**

**Generic PLC**

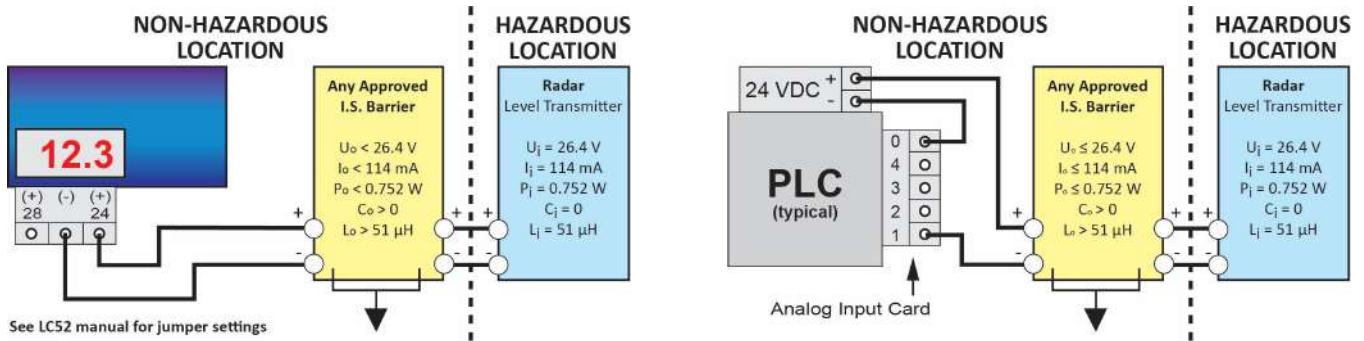

**Note:** Always refer to the Control Drawing 301901 for further wiring

**Generic Loop Powered Display**

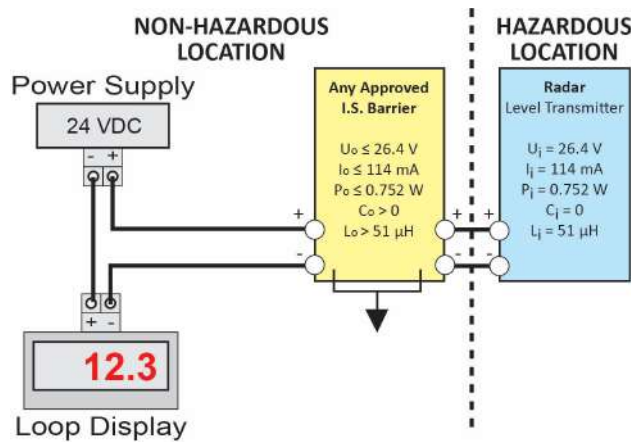

**Note:** Always refer to the Control Drawing 301901 for further wiring information.

\* Refer to the DataPoint™ LC52 Series Level Controller manual for information on JWA mode and JWB mode settings in the controller. Always use the LC52 in JWA mode with the EchoPro®.

**BASIC CONFIGURATION OVERVIEW**

Below are the 7 basic steps to configure the sensor for operation. Each step is described in detail on the following pages

- 1) Measure the Tank
  - a) Begin by measuring the key tank and fitting dimensions. Correct tank dimensions will result in accurate sensor measurement.
- 2) Set the Units of Measurement
  - a) Units can be configured in basic engineering units of length including Feet or Meters.
- 3) Set the Sensor Height
  - a) This is the empty setting (4mA) for the tank.
- 4) Set the Fill-Height
  - a) This is the full setting (20mA) for the tank.
- 5) Set the Max. Range (Maximum Range or MaxR)
  - a) This is the maximum measurement range for the sensor. The sensor will ignore all echo returns beyond this setting.
- 6) Set the Dead Band (Minimum Range or MinR)
  - a) This is the minimum measurement range for the sensor. The sensor will ignore all echo returns closer than this setting.
- 7) Check the Echo Curve
  - a) This is a quick diagnostic tool to determine if the sensor is reading the correct level.

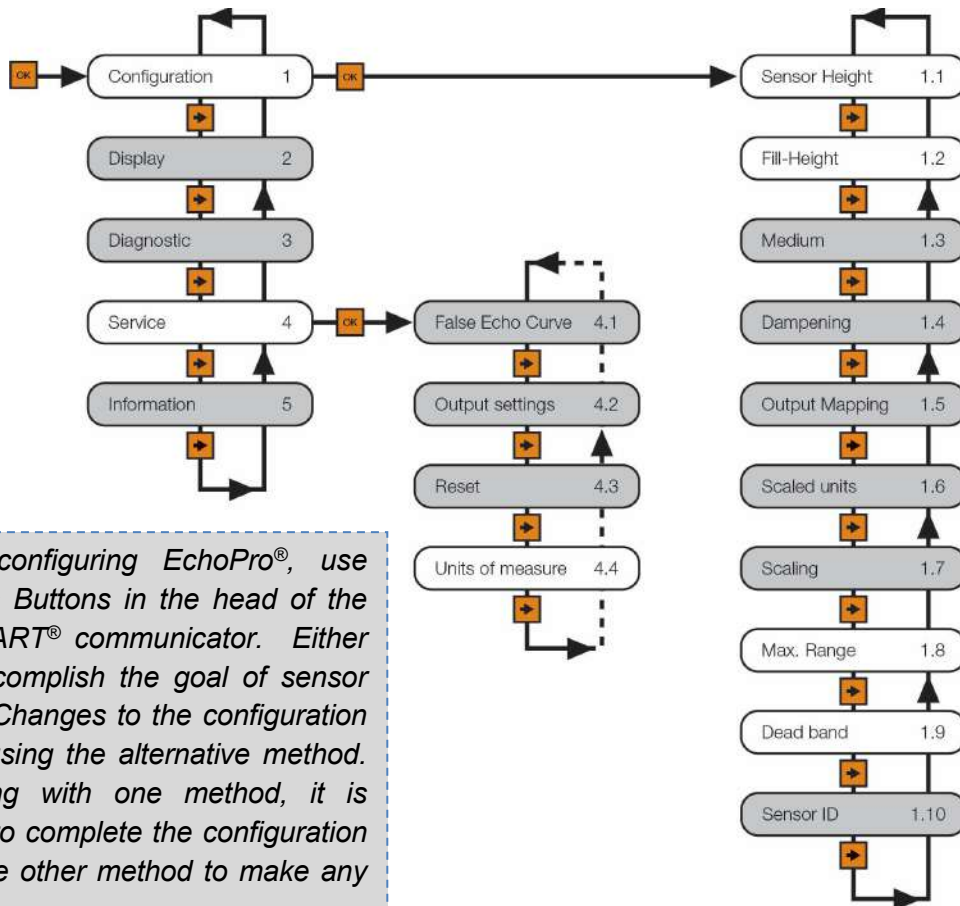

**Note:** When configuring EchoPro®, use either the Push Buttons in the head of the sensor or a HART® communicator. Either method will accomplish the goal of sensor configuration. Changes to the configuration can be made using the alternative method. When beginning with one method, it is recommended to complete the configuration before using the other method to make any adjustments.

**BASIC HART COMMUNICATOR OVERVIEW**

Follow the basic steps outlined on the previous page. Use a HART® communicator or HART® modem with emulation software. Be sure to download from the Flowline website and load the Device Descriptor (DD) files onto your communicator or emulation software. The DD files can be found on the individual EchoPro product pages at <https://www.flowline.com/echopro-solids-radar/>. The steps in bold can be used with HART®.

- 1) Measure the Tank
  - a) Begin by measuring the key tank and fitting dimensions. Correct tank dimensions will result in accurate sensor measurement.
- 2) Set the Units of Measurement**
  - a) Units can be configured in basic engineering units of length including Feet or Meters.
- 3) Set the Sensor Height**
  - a) This is the empty setting (4mA) for the tank.
- 4) Set the Fill-Height**
  - a) This is the full setting (20mA) for the tank.
- 5) Set the Max. Range (Maximum Range or MaxR)**
  - a) This is the maximum measurement range for the sensor. The sensor will ignore all echo returns beyond this setting.
- 6) Set the Dead Band (Minimum Range or MinR)**
  - a) This is the minimum measurement range for the sensor. The sensor will ignore all echo returns closer than this setting.
- 7) Check the Echo Curve**
  - a) This is a quick diagnostic tool to determine if the sensor is reading the correct level.

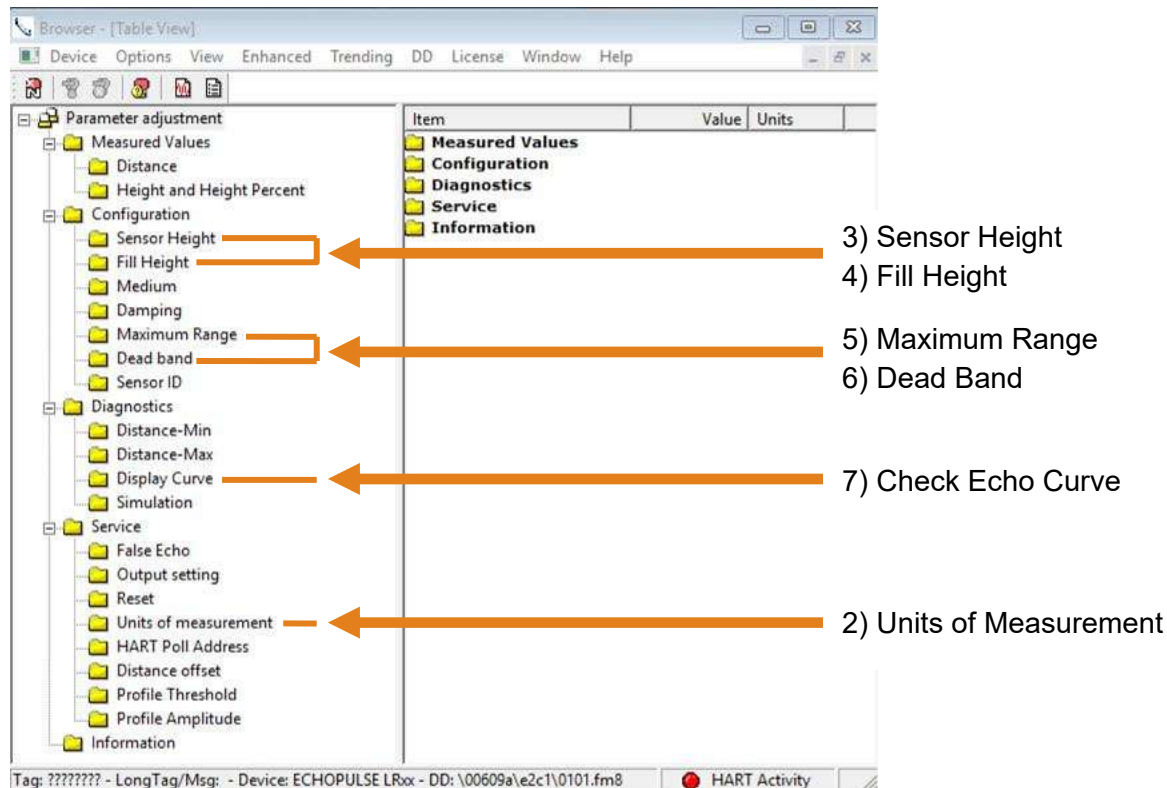

**BASIC HART COMMUNICATOR OVERVIEW (CONTINUED)**

**Units of Measurement**

To access Units of Measurement, click on the Service folder, then click on the Units of Measurement folder. Next click on Units of Measurement under Item and use the pull down to change the setting.

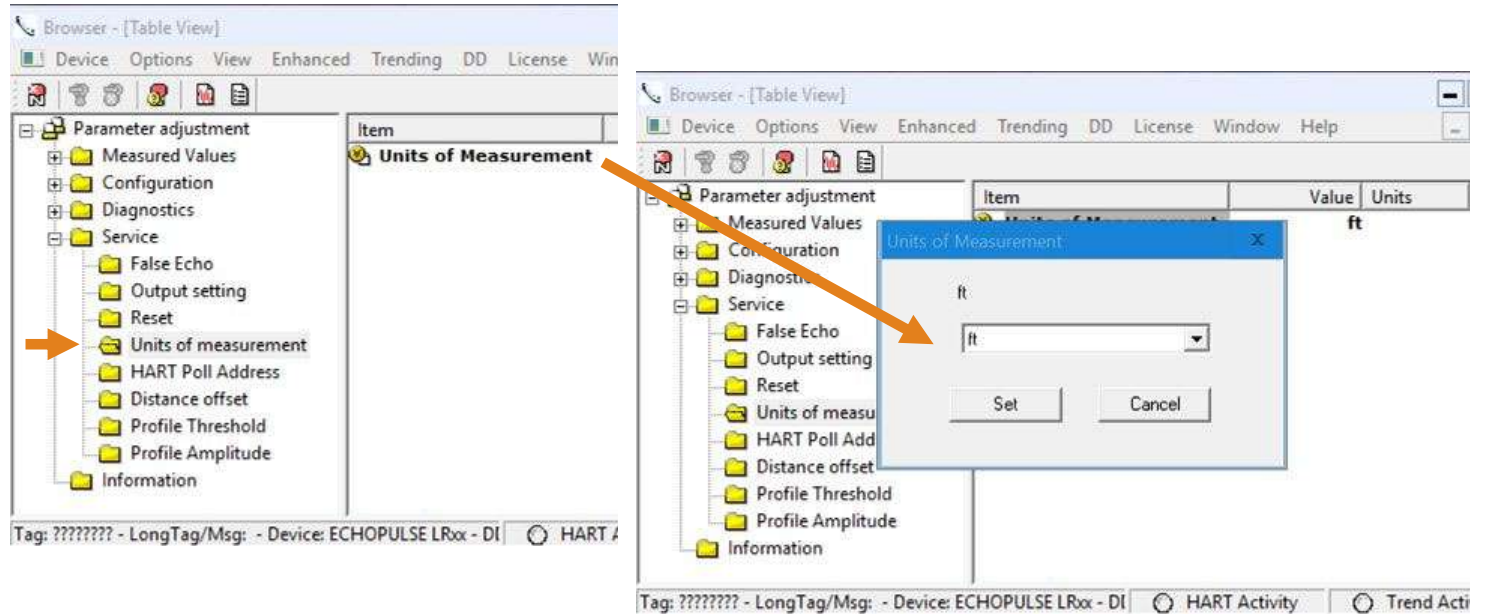

**Sensor Height**

To access Sensor Height, click on the Configuration folder, then click on the Sensor Height folder. Next click on Sensor Height under Item and use the number field to set the value in the units selected (ft or m).

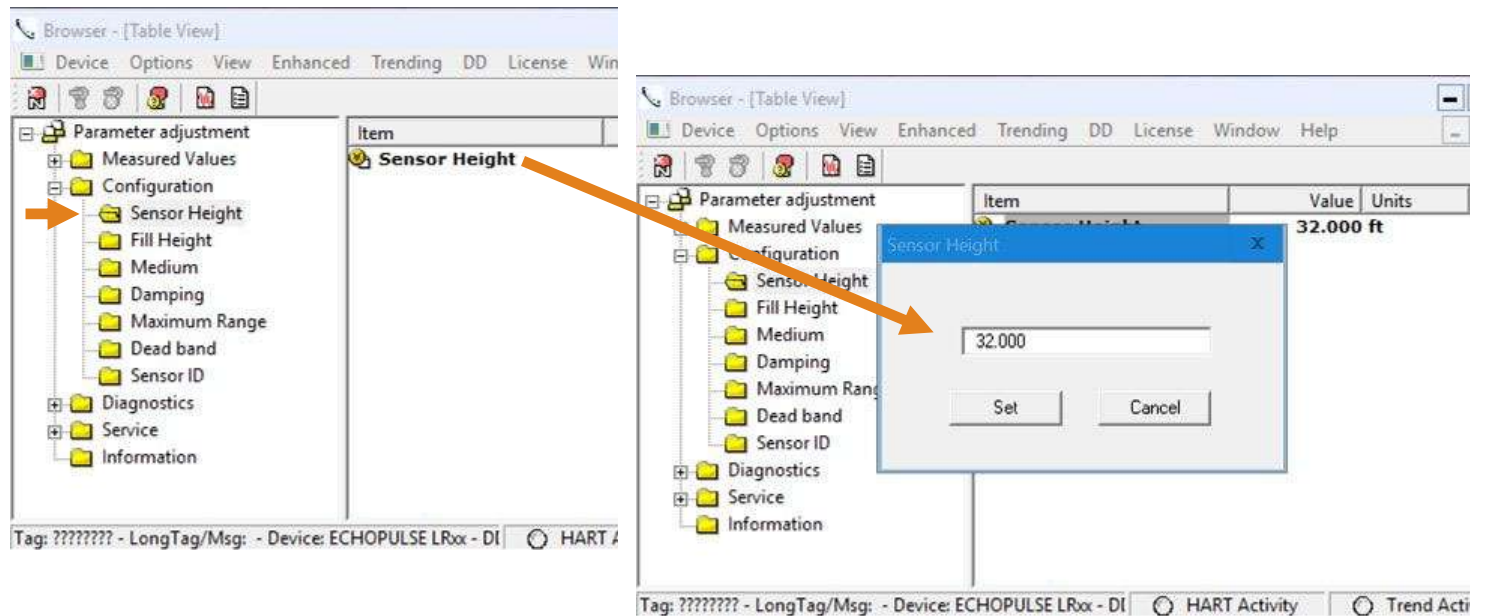

### BASIC HART COMMUNICATOR OVERVIEW (CONTINUED)

#### Fill-Height

To access Fill-Height, click on the Configuration folder, then click on the Fill-Height folder. Next click on Fill-Height under Item and use the number field to set the value in the units selected (ft or m).

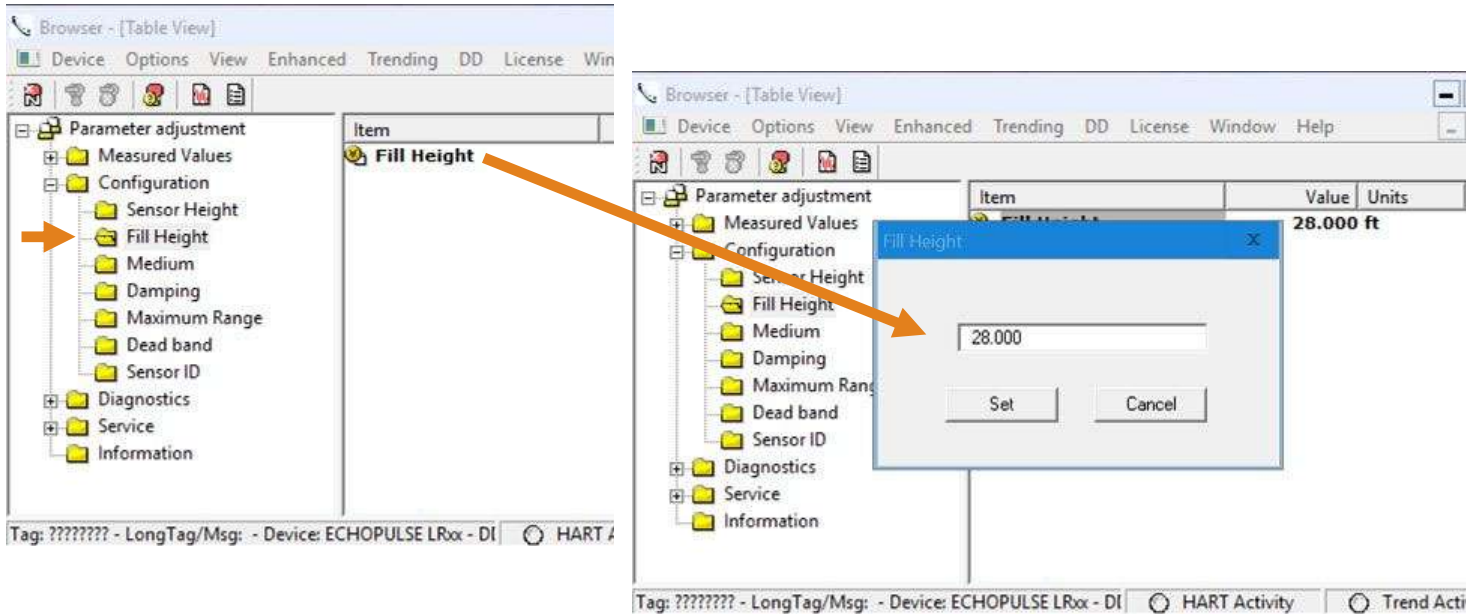

#### Maximum Range

To access Maximum Range, click on the Configuration folder, then click on the Max. Range folder. Next click on Max. Range under Item and use the number field to set the value in the units selected (ft or m).

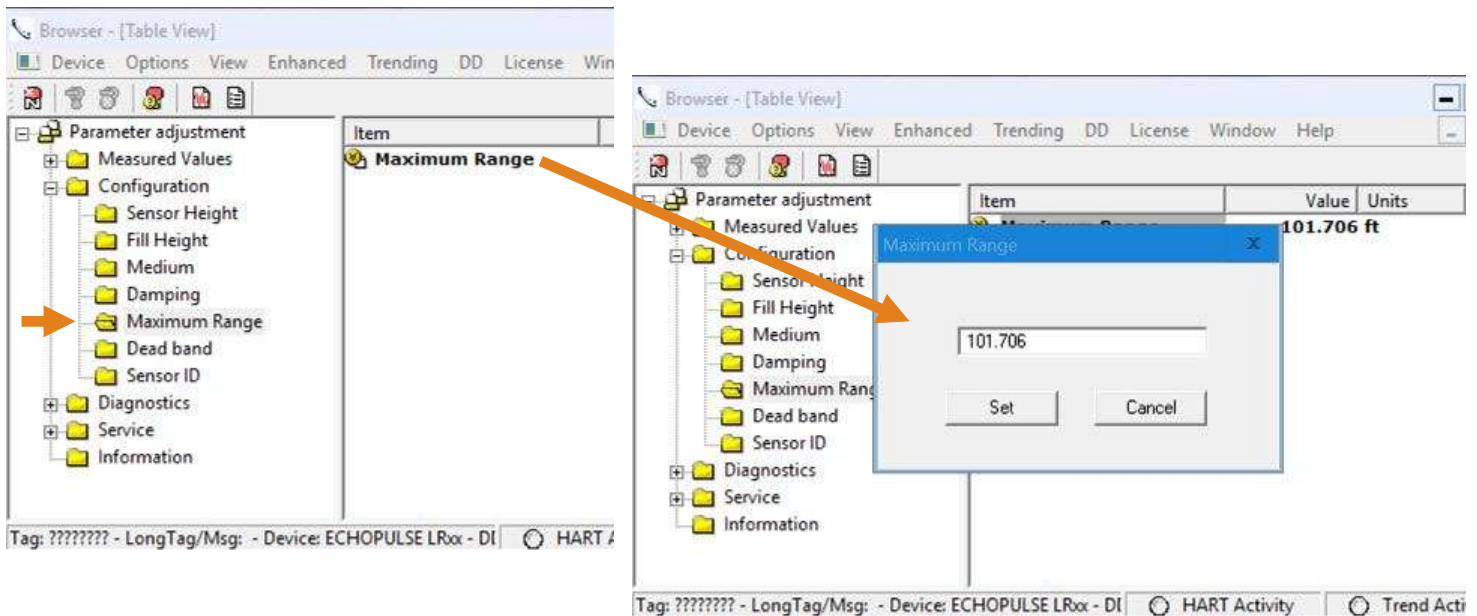

**BASIC HART COMMUNICATOR OVERVIEW (CONTINUED)**

**Dead Band**

To access Dead Band, click on the Configuration folder, then click on the Dead Band folder. Next click on Dead Band under Item and use the number field to set the value in the units selected (ft or m).

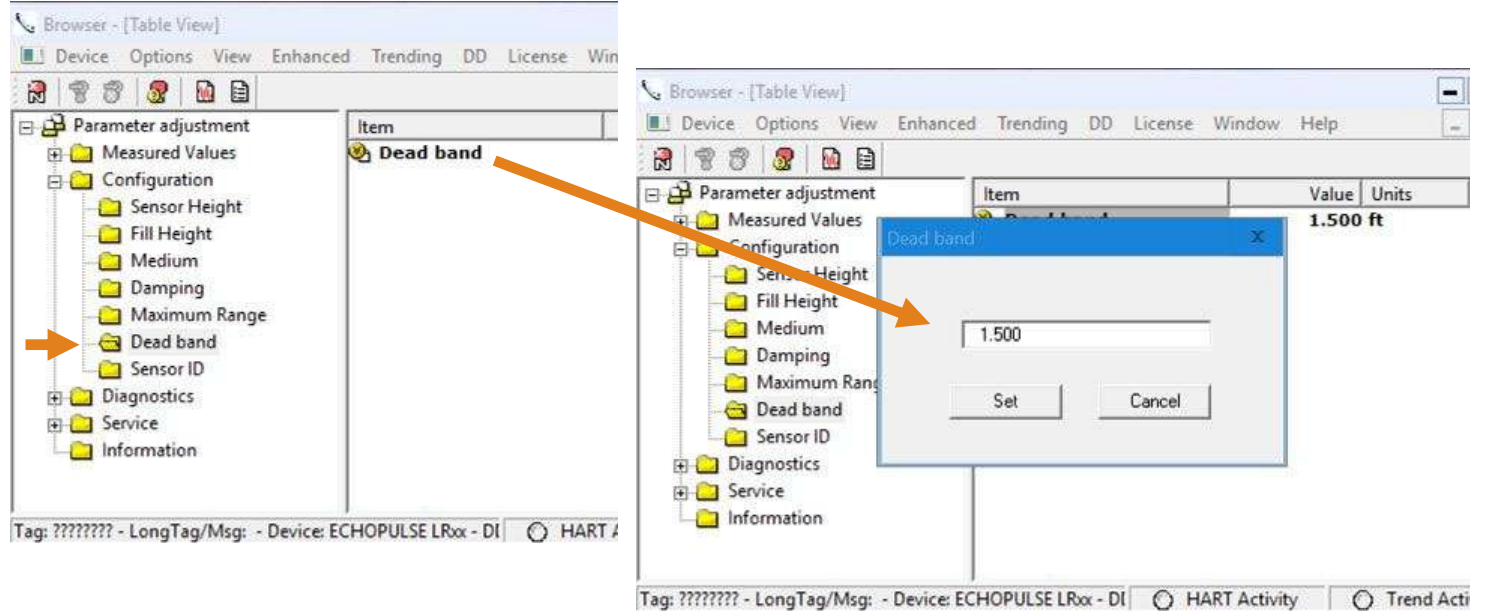

**Check Echo Curve**

To access Check Echo Curve, click on the Diagnostics folder, then click on the Display Curve folder. Next click on EchoCurve (curve) under Item and review the curve for the EchoPro®.

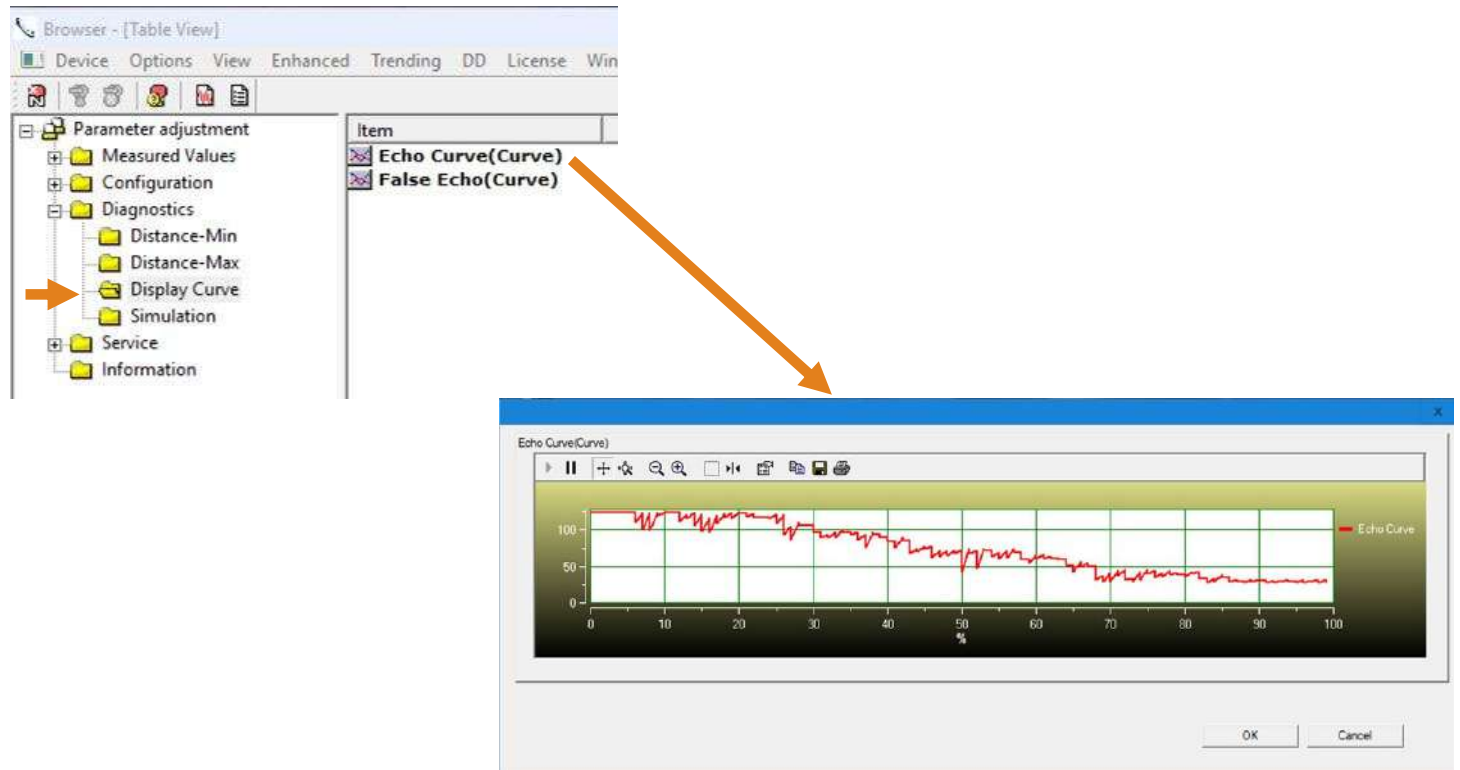

**USING THE DISPLAY**

The display module features a dot matrix LCD display with 4 push buttons on a removable puck. Out of the box, the display indicates level in feet and depicts the level within the 4-20mA span on a bar graph at the right side of the display. The four buttons perform the following functions:

<ul style="list-style-type: none"> <li>• <b>ESC</b> <ul style="list-style-type: none"> <li>○ Exit configuration mode</li> <li>○ Return to a higher menu level</li> <li>○ Display Echo Curve</li> </ul> </li> </ul>	<ul style="list-style-type: none"> <li>• <b>Up Arrow</b> <ul style="list-style-type: none"> <li>○ Modify parameter values</li> <li>○ Choose display mode</li> </ul> </li> </ul>
<ul style="list-style-type: none"> <li>• <b>Right Arrow</b> <ul style="list-style-type: none"> <li>○ Choose configuration options</li> <li>○ Choose parameter digits to edit</li> <li>○ Display contents of parameters</li> </ul> </li> </ul>	<ul style="list-style-type: none"> <li>• <b>OK</b> <ul style="list-style-type: none"> <li>○ Enter Menu and Options</li> <li>○ Confirm configuration options</li> <li>○ Confirm changes to parameters</li> </ul> </li> </ul>



**MENU INTRODUCTION**

- 1) To enter the Main Menu (from the Main Screen), press the **OK** button.
- 2) Use the **Right Arrow** button to scroll through the Main Menu options.
  - a) Configuration - Below are the configuration menu functions:
    - i) Sensor Height
    - ii) Fill-Height
    - iii) Medium
    - iv) Dampening
    - v) Output Mapping
    - vi) Scaled Units
    - vii) Scaling
    - viii) Max. Range
    - ix) Dead Band
    - x) Sensor ID
  - b) Display - This menu function sets the display mode and contrast.
  - c) Diagnostics - Below are the diagnostic menu functions:
    - i) Measurement of Peak Values
    - ii) Measurement Status
    - iii) Echo Curve
    - iv) Simulation
  - d) Service - Within the service menu functions, you can store a False Echo Curve, set units of measurement, change output settings, reset configuration settings, set language or set a PIN for the sensor.
  - e) Info - This item provides information on the sensor's type, serial number, date of manufacture and software version.
- 3) To select one of the functions, press **OK**.
- 4) To exit the programming mode, press **ESC**.

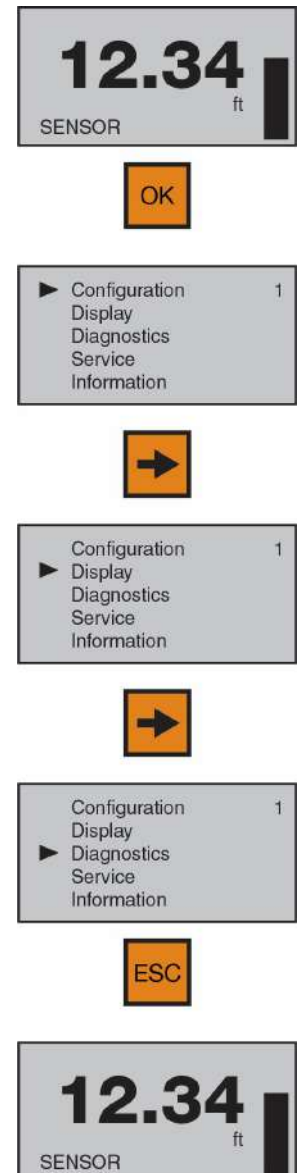

CHANGING DISPLAY VALUES

The numeric values are set using the **Right Arrow** and **Up Arrow** buttons. Press the **Right Arrow** button to select the next digit and the **Up Arrow** button to increment the digit value. The digit being changed is highlighted. Press the **OK** button to accept a setting or the **ESC** button to exit without saving changes. The below exercise illustrates how to change the value of an Empty configuration. Follow the steps to change the setting from 10.00 ft to 12.00 ft. This example applies to all functional settings starting from the Main Menu.

- 1) From the Main Menu, press **OK** to advance into the Configuration menu.
  - a) Sensor Height will appear on the top line of the screen.
- 2) From Sensor Height, press **OK**.
  - a) The “+” sign will be highlighted on the screen.
  - b) This is the adjustment for the percentage setting.
- 3) Press **OK** to move down to the distance setting.
  - a) The first digit, “1”, will be highlighted.
- 4) Press **Right Arrow** to move one digit to the right.
  - a) Use the **Right Arrow** button to move the digit one space to the right.
  - b) Pressing **Right Arrow** on the last digit will jump back to the first digit.
- 5) Press **UP ARROW** to increase the digit from “0” to “1”.
- 6) Press **UP ARROW** to increase the digit from “1” to “2”.
  - a) Use the **UP ARROW** button to increase the digit by one unit.
  - b) After “9”, the display will jump back to “0”.
- 7) Press **OK** to accept the setting as 12.00.
- 8) Press **ESCAPE** to move back to the Main Menu.

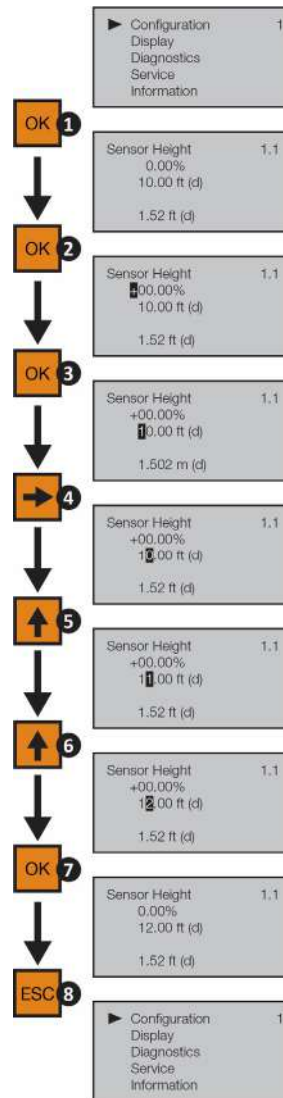

**STEP 1 - MEASURE THE TANK**

Measuring the tank is one of the most important aspects in configuring the sensor. When measuring the tank, take into account the location of the sensor with respect to fittings, risers, dome tops and bottoms, and identify where the measurements are taken from the sensor.

**Note:** The location for measurement may be different among different sensor Series, based upon the type of antenna. Refer to the Measurement Reference Chart for the measurement location of your sensor. The basic measurements for configuration are described below:

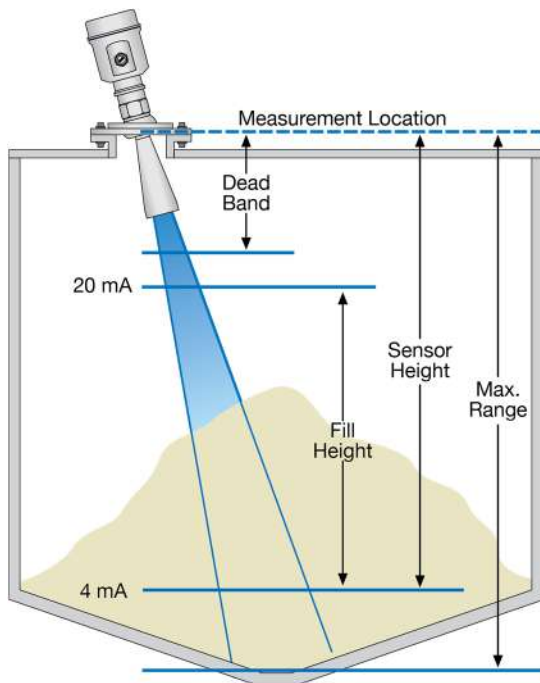

- 1) Distance from the sensor's measurement location to the bottom of the tank is the **Max. Range** value. The Range value is typically set at the bottom of the tank.
- 2) Distance from the sensor's measurement location to the empty or lowest media level in the tank is the **Sensor Height**.
  - a) Empty Configuration = 4mA setting.
  - b) With flat bottom tanks, the Max. Range and Sensor Height values can be the same.
- 3) Distance from the above 0% location to the full or highest media level in the tank is the **Fill-Height**.
  - a) Fill-Height = 20mA setting.

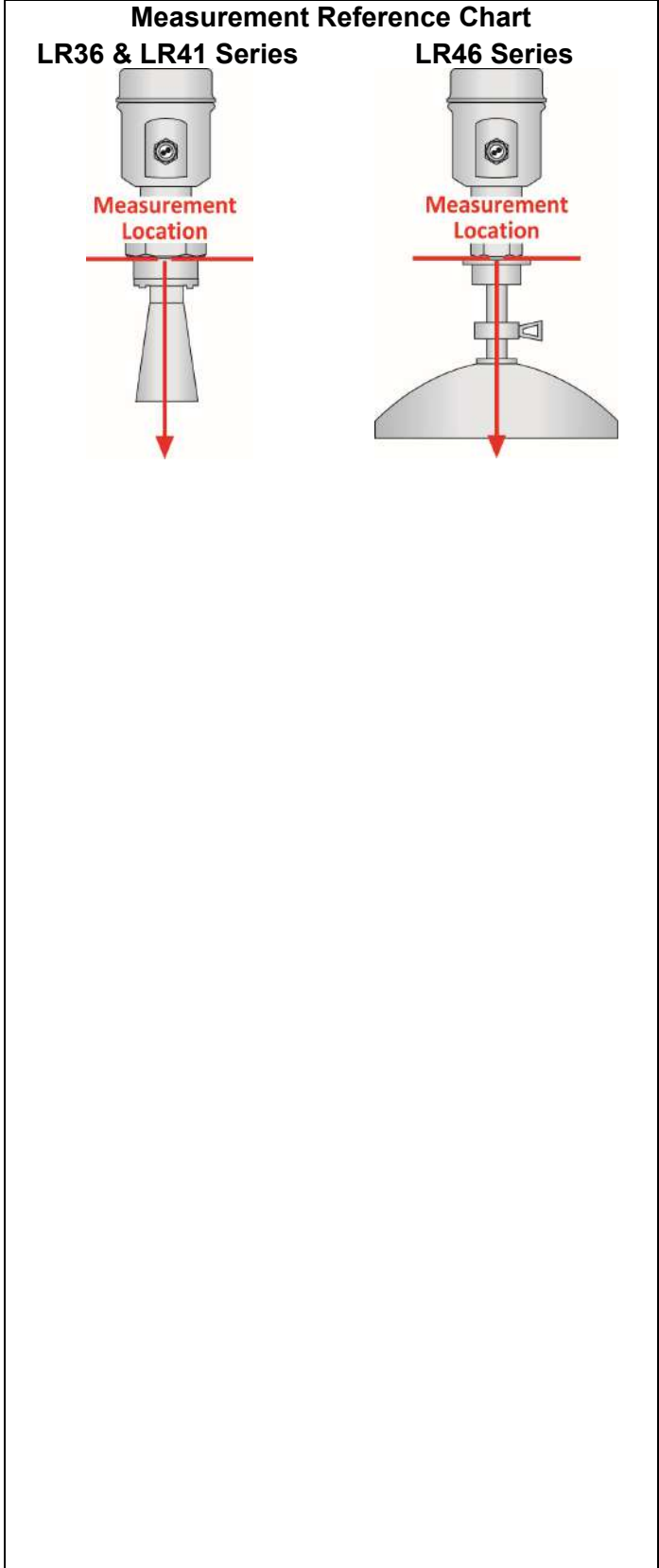

**STEP 2 - SET THE UNITS OF MEASUREMENT**

This function sets the units for all measurement values to be entered into the sensor.

- 1) From the Main Screen, press **OK** to advance into the Main Menu.
- 2) Press **Right Arrow** repeatedly until the arrow is next to Service.
- 3) Press **OK** to advance into the Service menu (and Echo curve will appear).
- 4) Press **Right Arrow** repeatedly until the menu shows Units of Measurement.
- 5) Press **OK** to advance into Units of Measurement.
- 6) Press **Right Arrow** to change the setting between feet [ft (d)] and meters [m (d)].
- 7) When the units are correct, press **OK** to save the setting.
- 8) When done, press **ESC** to return to the Main Menu, and press **ESC** a second time to return to the Main Screen.

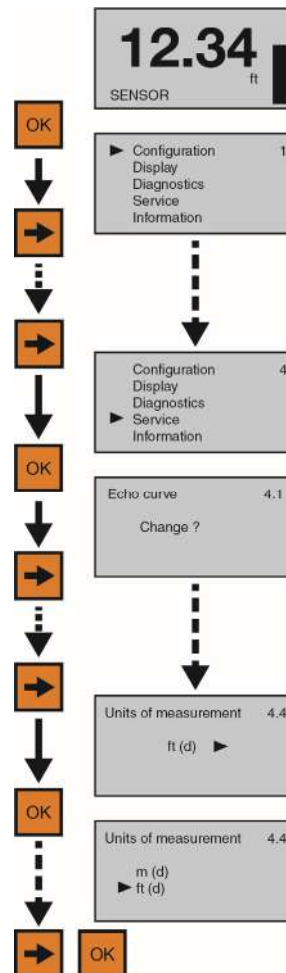

**STEP 3 - SET THE SENSOR HEIGHT (4MA)**

This function sets the Sensor Height point corresponding to an empty position in the tank. The measured distance of Sensor Height from the sensor will set the 4mA location as well as establish the 0% span of the sensor.

- 1) From the Main Screen, press **OK** to advance into the Main Menu.
- 2) Press **OK** to advance into the Configuration Menu.
- 3) Press **OK** to advance into Sensor Height. The first percentage segment will be highlighted.
- 4) Press **OK** again to switch to the distance (d) setting.
- 5) Press **Right Arrow** to move one segment to the right. **Right Arrow** will scroll left to right and then back to the first segment.
- 6) Press **Up Arrow** to increase the value of the number highlighted. **Up Arrow** will scroll from 0 to 9 and back again.
- 7) When the value is correct, press **OK** to save the setting.
- 8) When done, press **ESC** to return to the Main Menu, and press **ESC** a second time to return to the Main Screen or; if you want to advance directly into Fill-Height, press **Right Arrow**.

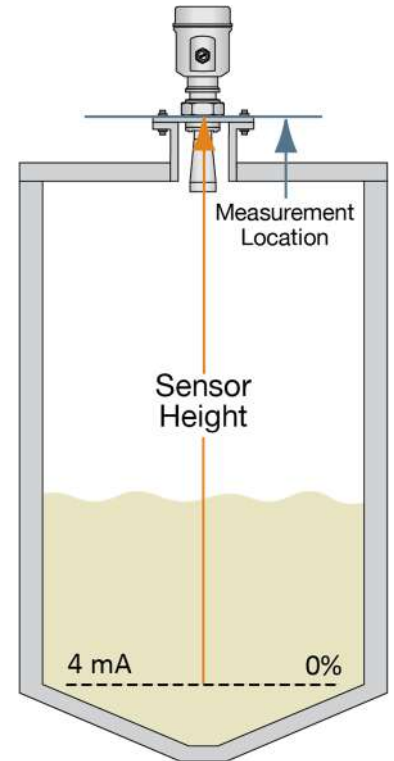

**STEP 4 - SET THE FILL-HEIGHT (20MA)**

This function sets the Fill-Height point corresponding to a full position in the tank. The measured distance of Fill-Height from the 0% or empty position will set the 20mA location as well as establish the 100% span of the sensor.

- 1) From the Main Screen, press **OK** to advance into the Main Menu.
- 2) Press **OK** to advance into the Configuration Menu.
- 3) Press **Right Arrow** to advance into Full Configuration.
- 4) Press **OK** to advance into Full Configuration. The first percentage segment will be highlighted.
- 5) Press **OK** again to switch to the distance (d) setting.
- 6) Press **Right Arrow** to move one segment to the right. **Right Arrow** will scroll left to right and then back to the first segment.
- 7) Press **Up Arrow** to increase the value of the number highlighted. **Up Arrow** will scroll from 0 to 9 and back again.
- 8) When the value is correct, press **OK** to save the setting.
- 9) When done, press **ESC** to return to the Main Menu, and press **ESC** a second time to return to the Main Screen or; If you want to advance directly into Range, press **Right Arrow** repeatedly until Max. Range appears.

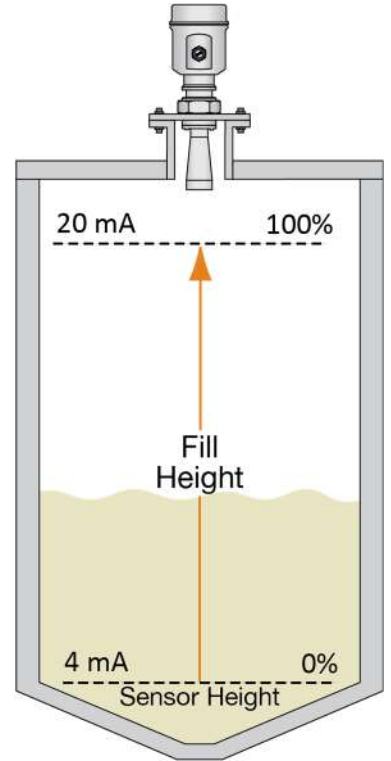
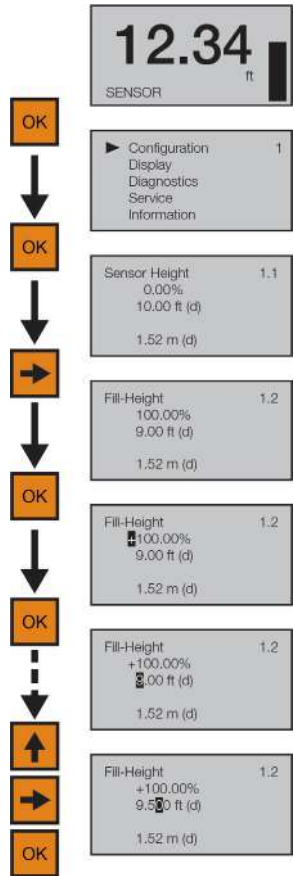

**STEP 5 - SET THE MAX. RANGE (MAXIMUM RANGE)**

This function sets the maximum operational range for the sensor. This setting defines the maximum distance that the sensor will detect valid echo returns.

- 1) From the Main Screen, press **OK** to advance into the Main Menu.
- 2) Press **OK** to advance into the Configuration Menu.
- 3) Press **Right Arrow** repeatedly until the menu shows Max. Range.
- 4) Press **OK** to edit Max. Range value. The first segment will be highlighted.
- 5) Press **Right Arrow** to move one segment to the right. **Right Arrow** will scroll left to right and then back to the first segment.
- 6) Press **Up Arrow** to increase the value of the number highlighted. **Up Arrow** will scroll from 0 to 9 and back again.
- 7) When the value is correct, press **OK** to save the setting.
- 8) When done, press **ESC** to return to the Main Menu, and press **ESC** a second time to return to the Main Screen or; if you want to advance directly into Dead Band, press **Right Arrow** repeatedly until Dead Band appears.

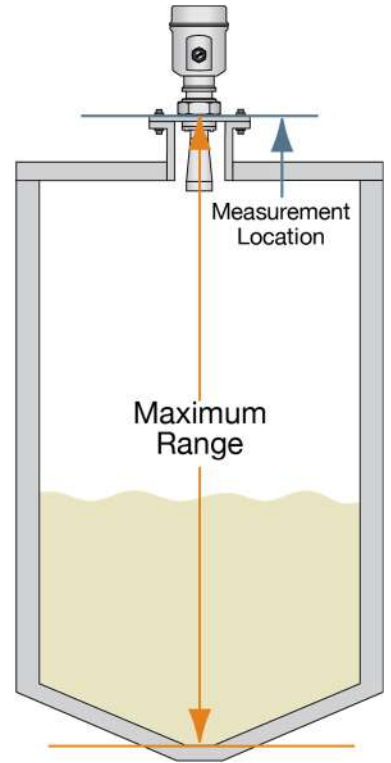
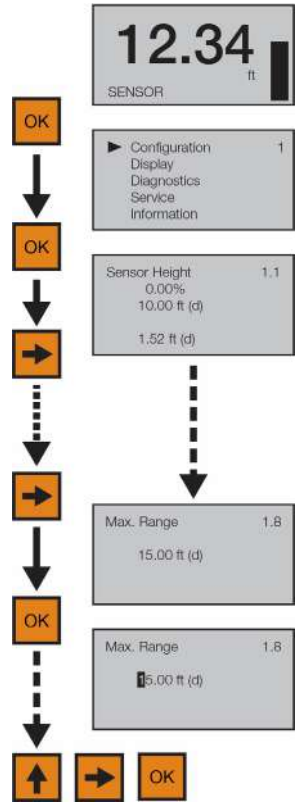

**STEP 6 - SET THE DEAD BAND**

This function sets the Dead Band for the sensor. This setting defines the minimum distance that the sensor will detect valid echo returns. While the Dead Band setting is typically configured to be equal with or slightly above (higher in the tank) the Full Configuration setting (20 mA), its functions independently of Full Configuration. **Note:** If the Dead Band setting is placed below the Full Configuration setting, then the sensor will not measure above the Dead Band.

**Dead Band Equals Full Config.**

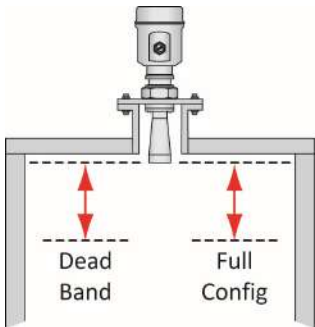

**Dead Band Below Full Config.**

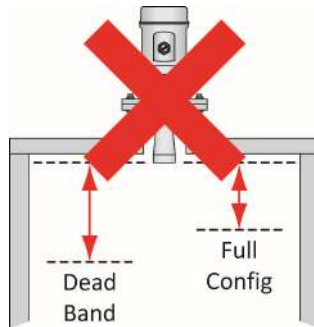

**Dead Band Above Full Config.**

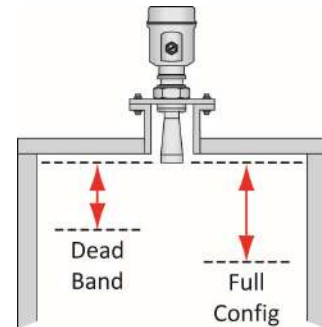

- 1) From the Main Screen, press **OK** to advance into the Main Menu.
- 2) Press **OK** to advance into the Configuration Menu.
- 3) Press **Right Arrow** repeatedly until menu shows Dead Band.

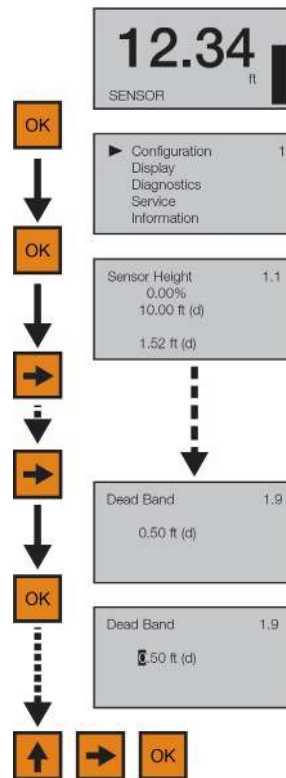

- 4) Press **OK** to edit Dead Band value. The first segment will be highlighted.
- 5) Press **Right Arrow** to move one segment to the right. **Right Arrow** will scroll left to right and then back to the first segment.

- 6) Press **Up Arrow** to increase the value of the number highlighted. **Up Arrow** will scroll from 0 to 9 and back again.
- 7) When the value is correct, press **Enter** to save the setting.
- 8) When done, press **ESC** to return to the Main Menu, and press **ESC** a second time to return to the Main Screen.

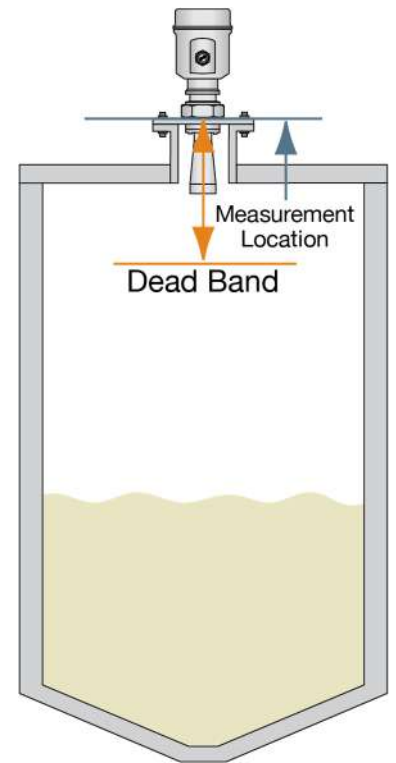

**STEP 7 - CHECK THE ECHO CURVE**

This function displays the primary echo return(s) that the sensor is seeing graphically, the location and amplitude of the return(s), and the numeric air gap distance from the sensor’s measurement location to the media level below.

**Note:** This step should only be performed after having completed the prior six configuration steps with the sensor installed on the tank. Additionally, if the sensor was installed in a stand pipe or sight glass, now go forward to Section Six and turn on the still well function (Sensor Installed in a Stand Pipe or Sight Glass) before continuing with this step.

- 1) From the Main Screen, press **ESC** and the Echo Curve Screen will appear. The curve graphically represents the primary echo return(s) amplitude (Y-axis) over distance (X-axis). Above the echo return peak is a floating arrow and triangle symbol (which under normal conditions are often merged together or seen as a single triangle because it’s the larger of the two symbols). The arrow represents the measured media level and the triangle represents the peak amplitude location of the echo return. Under normal conditions, expect to see a stable triangle (or overlapping arrow and triangle) floating above a pronounced peak at the expected air gap distance between the measurement location and media level.
- 2) In the upper right hand corner of the screen are two lines of numbers that represent the air gap distance from the measurement location to the media level (arrow) on the top, and peak amplitude location (triangle) of the echo return on the bottom. Under normal conditions, these values should be relatively close to one another and consistent with the expected air gap distance between the measurement location and media level.
- 3) Assuming that the sensor is properly installed, if the measured media level and peak amplitude location data (symbols and values) are unstable, substantially different from one another and/or inconsistent with the actual air gap distance, then this likely indicates that the sensor requires additional process adjustment(s) described in the following Section Six.
- 4) When done, press **ESC** to return to the Main Menu.

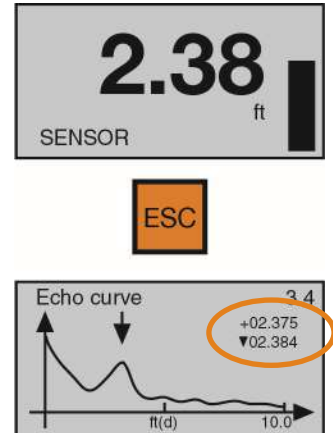

## PROCESS ADJUSTMENTS OVERVIEW

These optional functions are intended to improve sensor performance in applications with the below process and/or installation characteristics. **Note:** *These adjustments should only be performed when (after having completed the seven configuration steps described in Section Five with the sensor installed on the tank) the sensor is not performing to your satisfaction.* Where so, perform the following applicable Process Adjustments.

- 1) Fast Level Change - Fast Filling or Emptying of the Solids
- 2) Low Dielectric - Solids with Low Dielectric
- 3) Powder/Dust - Solids with moderate or significant powder or dust
- 4) Large Angle - Solids with Large Angle of repose
- 5) First Echo - Solids Requiring First Echo Adjustment

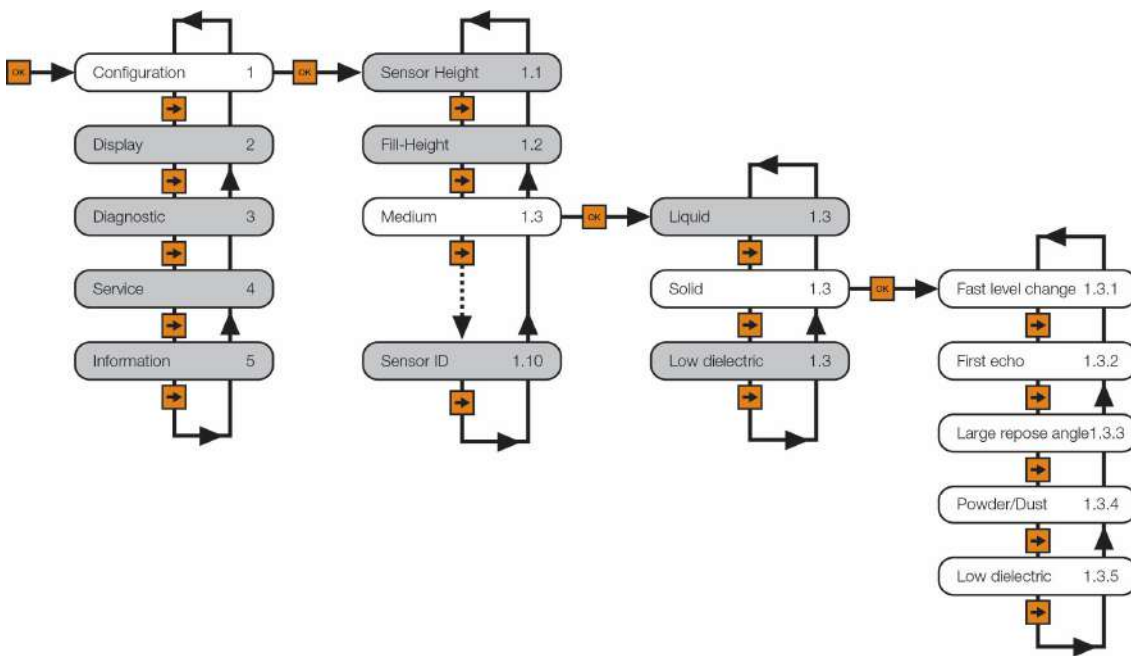

**FAST FILLING OR EMPTYING OF SOLIDS (FAST LEVEL CHANGES)**

If the speed of media level rise or fall within the tank is greater than a rate of 1" per second (25.4mm/sec), set Fast Level Change to Yes. **Note:** *Fast filling or emptying can occur when multiple pumps are operating or when a weather event increases the amount of media entering the tank.*

- 1) From the Main Screen, press **OK** to advance into the Main Menu.
- 2) Press **OK** to advance into the Configuration Menu.
- 3) Press **Right Arrow** to advance from Sensor Height to Fill-Height.
- 4) Press **Right Arrow** to advance from Fill-Height to Medium.
- 5) Press **OK** to advance into Medium. Liquid, Solid, Low Dielectric will appear.
- 6) Press **OK** to advance into Solid. Fast Level Change will appear first.
- 7) Press **OK** to advance into Fast Level Change.
- 8) Press **Right Arrow** to change the Fast Level Change setting.
- 9) When the setting is correct, press **OK** to save.
- 10) When done, press **ESC** to return to Medium, press **ESC** again to return to the Configuration Menu, and press **ESC** a third time to return to the Main Screen or; If you want to advance directly into First Echo, press **Right Arrow** repeatedly until First Echo appears.

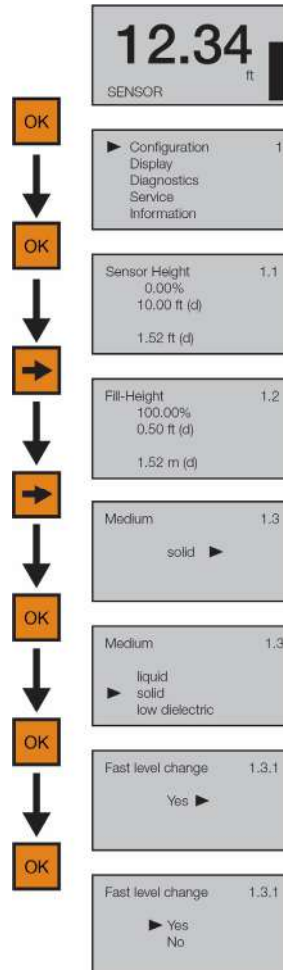

**Normal Level Change**

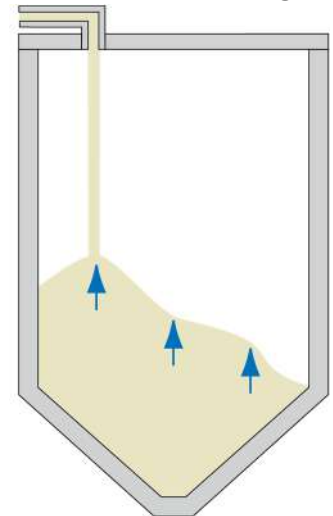

**Fast Level Change**

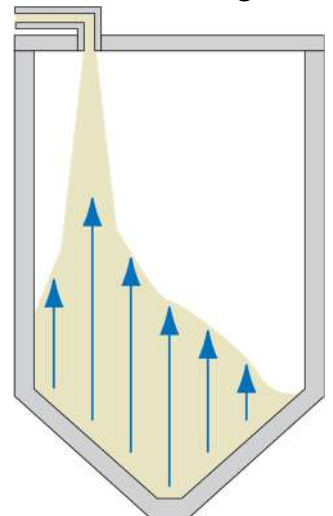

### SOLIDS WITH LOW DIELECTRIC

Used when the media has a low dielectric constant (typically under 10). Selections are YES or NO. **Default is NO.**

- 1) From the Main Screen, press **OK** to advance into the Main Menu.
- 2) Press **OK** to advance into the Configuration Menu.
- 3) Press **Right Arrow** repeatedly until menu shows Medium.
- 4) Press **OK** to advance into Medium. Liquid, Solid & Low Dielectric will appear.
- 5) Press **OK** to advance into Solids. Fast Level Change will appear first.
- 6) Press **Right Arrow** repeatedly until Low Dielectric appears.
- 7) Press **OK** to advance into Low Dielectric.
- 8) Press **Right Arrow** to change the setting from No to Yes.
- 9) Press **OK** to enter the Pipe Diameter.
- 10) When the value is correct, press **OK** to save.
- 11) When done, press **ESC** to return to Medium, press **ESC** again to return to the Configuration Menu, and press **ESC** a third time to return to the Main Screen.

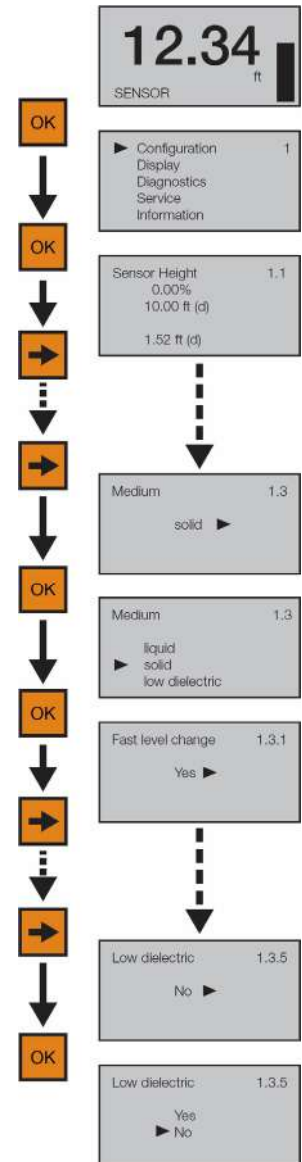

**SOLIDS WITH MODERATE OR SIGNIFICANT POWDER OR DUST**

If moderate to significant powder or dust is present in the application, set Powder / Dust to Yes.

- 1) From the Main Screen, press **OK** to advance into the Main Menu.
- 2) Press **OK** to advance into the Configuration Menu.
- 3) Press **Right Arrow** to advance from Sensor Height to Fill-Height.
- 4) Press **Right Arrow** to advance from Fill-Height to Medium.
- 5) Press **OK** to advance into Medium. Liquid, Solid, Low Dielectric will appear.
- 6) Press **OK** to advance into Solid. Fast Level Change will appear first.
- 7) Press **Right Arrow** repeatedly until Powder / Dust 1.3.4 appears.
- 8) Press **OK** to advance into Powder / Dust.
- 9) Press **Right Arrow** to change the Powder / Dust setting.
- 10) When the setting is correct, press **OK** to save.
- 11) When done, press **ESC** to return to Medium, press **ESC** again to return to the Configuration Menu, and press **ESC** a third time to return to the Main Screen or; If you want to advance directly into Low Dielectric, press **Right Arrow** repeatedly until Low Dielectric appears.

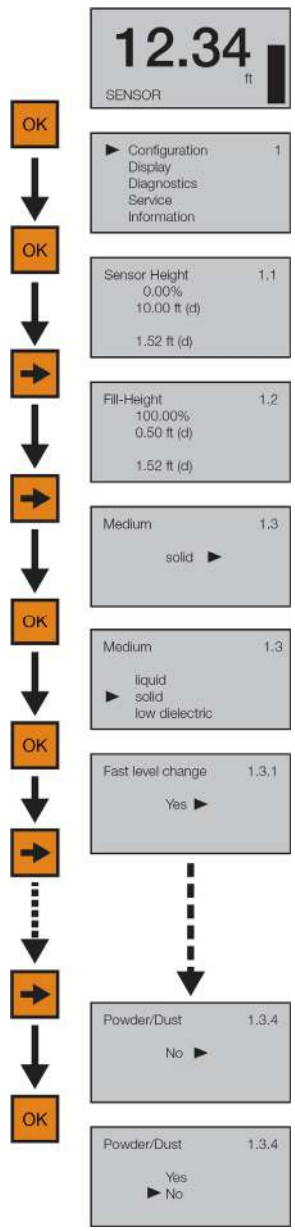

**Moderate Powder / Dust** – occurs primarily when it collects along the top or bottom of the tank.

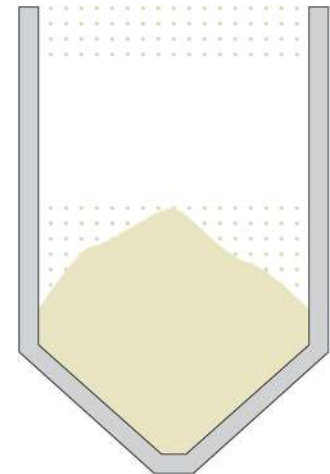

**Significant Powder / Dust** – occurs when the air space is filled from the media to the top.

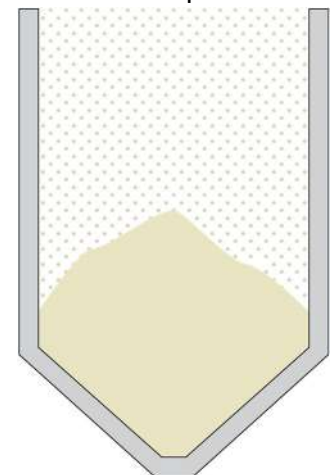

**SOLIDS WITH LARGE ANGLE OF REPOSE**

The angle of repose is the steepest angle of rise or dip relative to the horizontal plane to which a material can be piled without slumping. If the morphology of the media creates an Angle of Repose above 35°, set Large Repose Angle to Yes.

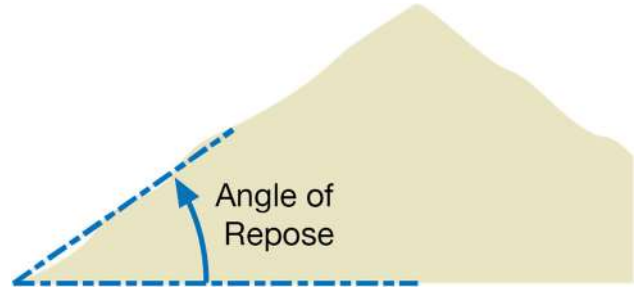

- 1) From the Main Screen, press **OK** to advance into the Main Menu.
- 2) Press **OK** to advance into the Configuration Menu.
- 3) Press **Right Arrow** repeatedly until menu shows Medium.
- 4) Press **OK** to advance into Medium. Liquid, Solid, Low Dielectric will appear.
- 5) Press **OK** to advance into Solid. Fast Level Change will appear first.
- 6) Press **Right Arrow** repeatedly until Large Repose Angle appears.
- 7) Press **OK** to advance into Large Repose Angle.
- 8) Press **Right Arrow** to change the Large Repose Angle setting.
- 9) When the setting is correct, press **OK** to save.
- 10) When done, press **ESC** to return to Medium, press **ESC** again to return to the Configuration Menu, and press **ESC** a third time to return to the Main Screen or; If you want to advance directly into Powder/Dust, press **Right Arrow** repeatedly until Powder/Dust appears.

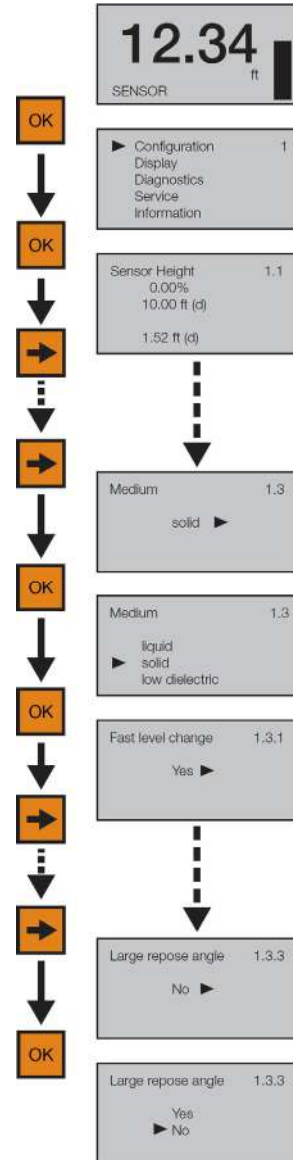

**SOLIDS REQUIRING FIRST ECHO ADJUSTMENT**

This function increases or decreases the peak strength of the sensor’s First Echo return, and should only be performed if: 1) The media has a very high dielectric constant value and primarily stays in the near full range of the tank, resulting in a very high First Echo peak strength or; 2) Process conditions, such as when the media has a very low dielectric constant value, or when obstructions, heavy foam or turbulence exist in the tank, resulting in little or no First Echo peak strength. **Note:** Under condition one (Example 1), it can be beneficial to decrease the First Echo peak strength. Under condition two (Example 3), it can be beneficial to increase the First Echo peak strength.

**Example 1**

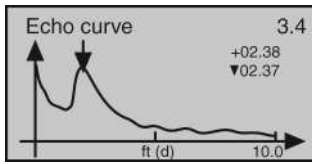

First Echo peak is very strong and can be reduced.

**Example 2**

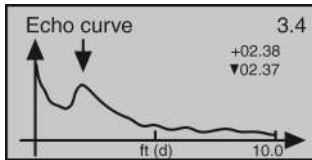

First Echo peak is normal and no adjustment is required.

**Example 3**

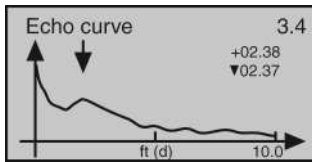

First Echo peak is weak and can be increased.

**First Echo Adjustments**

- Normal - No adjustment
- Small - Decrease by 10 dB
- Big - Increase by 10 db
- Bigger - Increase by 20 db
- Biggest - Increase by 40 db

- 1) From the Main Screen, press **OK** to advance into the Main Menu.
- 2) Press **OK** to advance into the Configuration Menu.
- 3) Press **Right Arrow** to move from Empty Configuration to Full Configuration.
- 4) Press **Right Arrow** to move from Full Configuration to Medium.
- 5) Press **OK** to advance into Medium and Liquid, Solid & Low Dielectric will appear.
- 6) Press **OK** to advance into Solids and Fast Level Change will appear.
- 7) Press **Right Arrow** to move from Fast Level Change to First Echo.
- 8) Press **OK** to advance into First Echo.
- 9) Press **Right Arrow** to change the First Echo setting.
- 10) When setting is correct, press **OK** to save.
- 11) When done, press **ESC** to return to Medium, press **ESC** again to return to the Configuration Menu, and press **ESC** a third time to return to the Main Screen or; If you want to advance directly into Large Repose Angle, press **Right Arrow** repeatedly until Large Repose Angle.

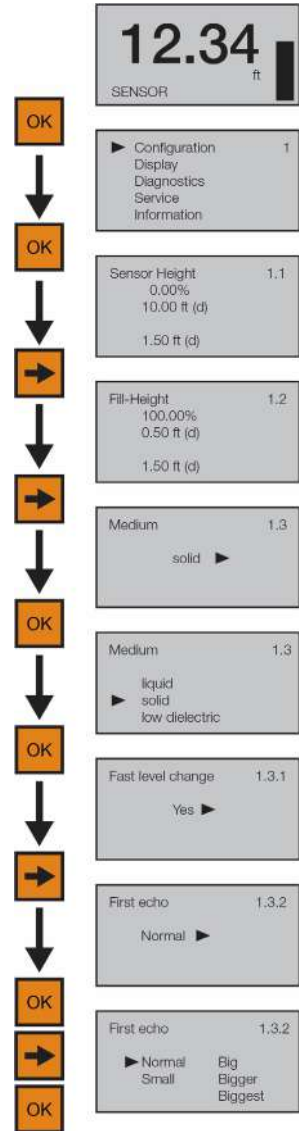

## ADVANCED ADJUSTMENTS OVERVIEW

These optional functions are used to change the sensor output characteristics, or Create a False Echo Curve to filter out false echo returns within the tank (improving sensor performance), or Update an existing False Echo Curve filter if the original filter was not created during an empty tank condition.

- 1) **4-20 mA Rev Output** - Reverses the current output from 4mA @ bottom and 20mA @ top of tank to 20mA @ bottom and 4mA @ top of the tank.
- 2) **Fail-Safe** - Allows for the presetting of the current output when a sensor failure occurs. Options are no change to current, 20.5mA or 22mA.
- 3) **Minimum Current** - Sets the minimum current output for the sensor. Options are 4.0mA or 3.9mA.
- 4) **HART® Operational Mode** – Sets the device address as well as sets the current draw for the device.
- 5) **Create a new False Echo Curve** - A method to filter out false echo returns within the tank. This should be performed when the tank is at its lowest level (empty).
- 6) **Update an existing False Echo Curve** - A method to update an existing False Echo Curve to include a lower section of the tank that was not exposed during the creation of the original Echo Curve. **Note:** *If you don't know the location (level position) or validity of the original False Echo Curve, it is recommended to delete the original Echo Curve, and then create a new False Echo Curve (versus updating an existing False Echo Curve).*

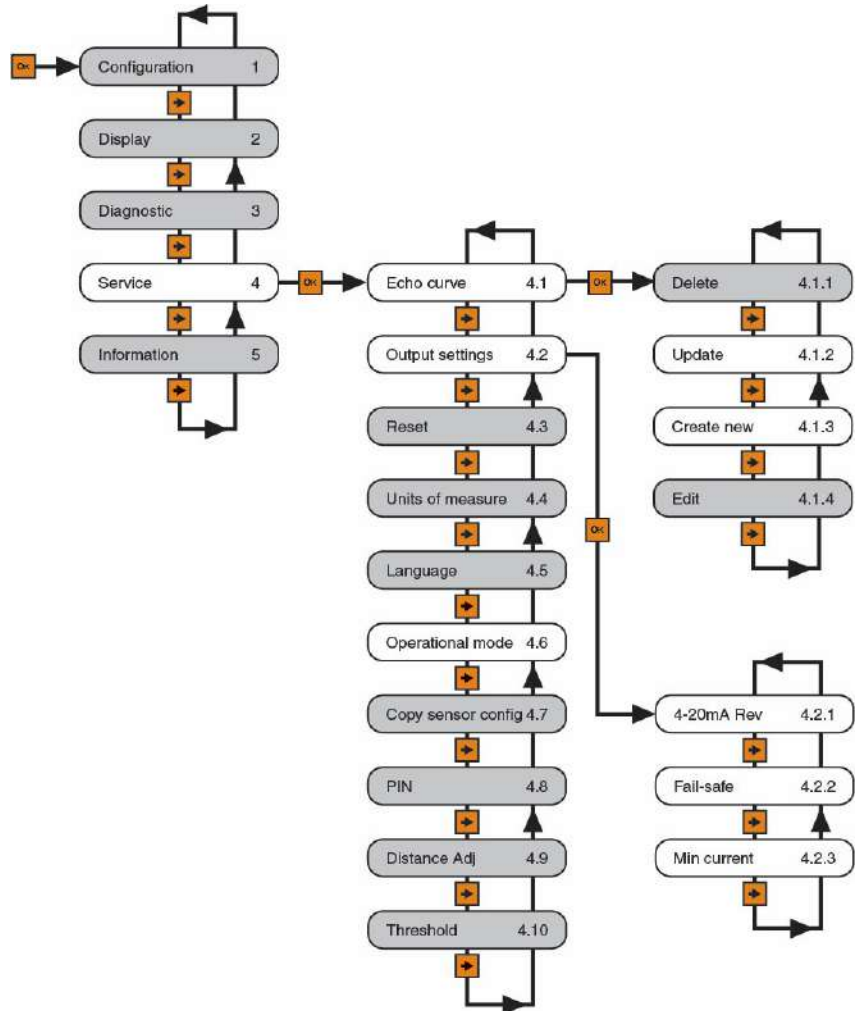

## 4-20 MA REVERSE OUTPUT

This function sets the current output at either 4-20 mA or 20-4 mA. Selecting 4-20 mA sets the output with 4mA @ bottom and 20mA @ top of the tank. This is the standard output used in the majority of applications. Selecting 20-4 mA sets the output with 20mA @ bottom and 4mA @ top of the tank. This is an optional output sometimes used in applications where the level is maintained at a high level.

- 1) From the Main Screen, press **OK** to advance into the Main Menu.
- 2) Press **Right Arrow** repeatedly until the arrow is next to Service.
- 3) Press **OK** to advance into Service Menu.
- 4) Press **Right Arrow** to move from Echo Curve to Output Current.
- 5) Press **OK** to advance into Output Current.
- 6) Press **OK** to advance into 4-20mA Rev.
- 7) Press **Right Arrow** to change the setting between 4-20mA and 20-4mA.
- 8) When the setting is correct, press **OK** to save.
- 9) When done, press **ESC** to return to the Service Menu and press **ESC** a second time to return to the Main Screen or; if you want to advance directly into Fail-Safe, press **Enter** and then **Right Arrow** until Fail-Safe appears. When done, press **ESC** to return to the Service Menu and press **ESC** a second time to return to the Main Screen or; if you want to advance directly into Fail-Safe, press **Enter** and then **Right Arrow** until Fail-Safe appears.

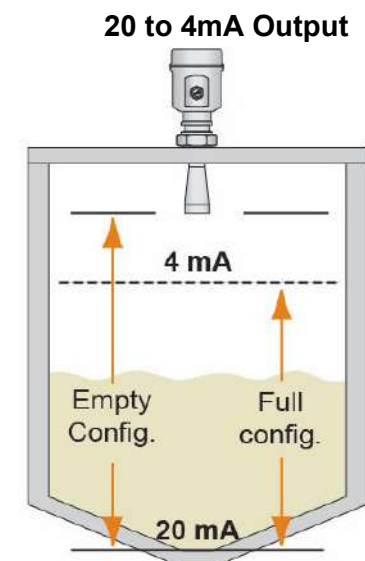
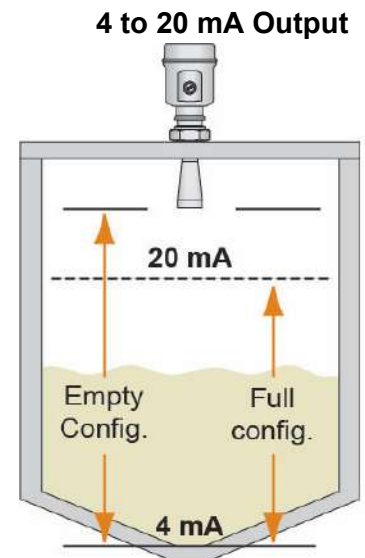
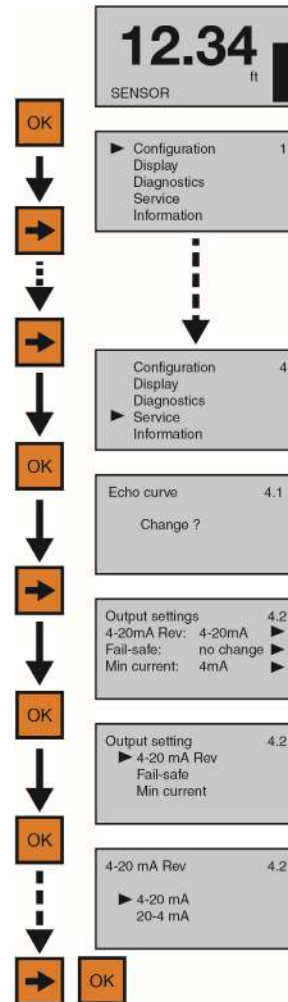

## FAIL-SAFE OUTPUT

This function is used to set the current output to a designated state if the sensor loses measurement confidence. Selecting No Change will hold the current at its last valid current output. Selecting 20.5mA will force the current to jump to 20.5mA. Selecting 22.5 mA will force the current to jump to 22.5 mA. **Note:** The latter two high current output states are above the standard 4-20 mA operational range, and can be used to indicate that a failure has occurred.

- 1) From the Main Screen, press **OK** to advance into the Main Menu
- 2) Press **Right Arrow** repeatedly until the arrow is next to Service.
- 3) Press **OK** to advance into Service Menu and Echo Curve will appear.
- 4) Press **Right Arrow** to move from Echo Curve to Output Current.
- 5) Press **OK** to advance into Output Current menu.
- 6) Press **Right Arrow** to move from Reverse 4-20mA to Fail-safe.
- 7) Press **OK** to enter Fail-safe.
- 8) Press **Right Arrow** to change the setting between No change, 20.5mA and 22.0mA.
- 9) When the setting is correct, press **OK** to save.
- 10) When done, press **ESC** to return to the Service Menu and press **ESC** a second time to return to the Main Screen or; if you want to advance directly into Min Current, press **Enter** and then **Right Arrow** until Min Current appears.

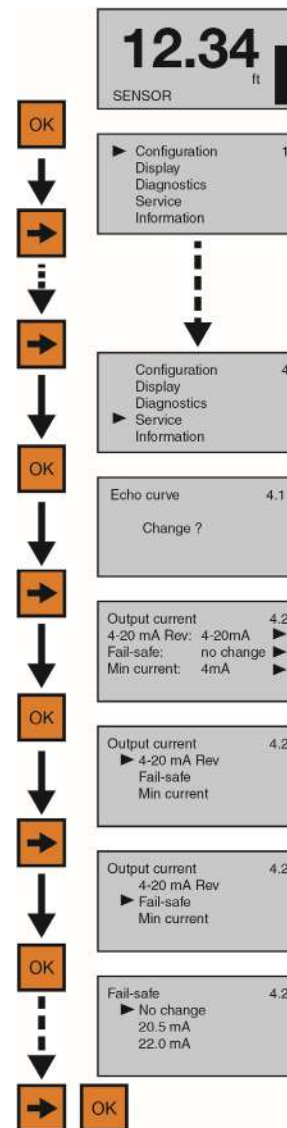

## MINIMUM CURRENT OUTPUT

This function sets the minimum current output for the sensor at either 4.0mA or 3.9mA. **Note:** 4.0mA is the default minimum current output and is used in the majority of applications.

- 1) From the Main Screen, press **OK** to advance into the Main Menu.
- 2) Press **Right Arrow** repeatedly until the arrow is next to Service.
- 3) Press **OK** to advance into Service Menu and Echo Curve will appear.
- 4) Press **Right Arrow** to move from Echo Curve to Output Current.
- 5) Press **OK** to advance into Output Current menu.
- 6) Press **Right Arrow** repeatedly to move from Reverse 4-20mA to Min Current.
- 7) Press **OK** to enter Min Current.
- 8) Press **Right Arrow** to change the setting between 3.9mA and 4.0mA.
- 9) When the setting is correct, press **OK** to save.
- 10) When done, press **ESC** to return to the Service Menu and press **ESC** a second time to return to the Main Screen.

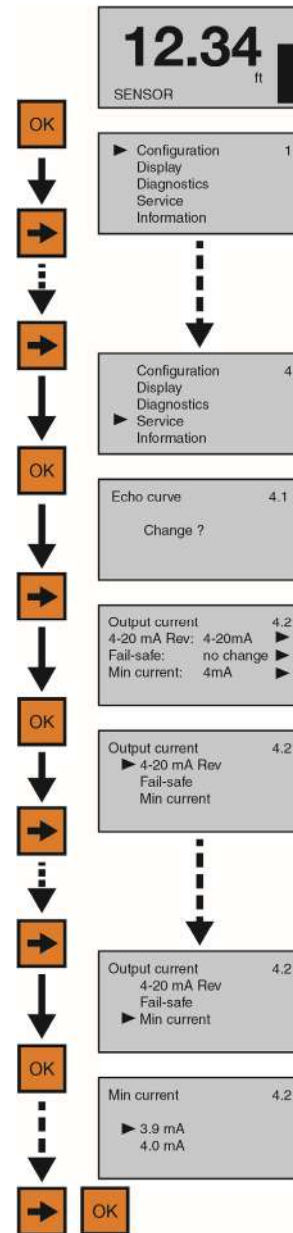

## HART® OPERATION MODE

This feature sets the HART® address for operation as well as setting the output current for HART® operation.

- HART® Address
  - Standard – address 0 (default). Use in a single device per loop configuration.
  - Multi-drop – addresses 1 to 15. Allows for multiple sensors to share the same wiring. Each sensor must have a unique address. The current loop will hold when address is set from 1 to 15.
- HART® Current
  - Standard – 0 (default). 4-20 mA output is active when address is set to 0.
  - Multi-drop – Choose between 4mA or 8mA as the static current. Power supply must be able to provide power for all devices placed on the loop at the set current. Default is 4mA.

- 1) From the Main screen, Press **Enter** to enter Menu.
- 2) Press **Right Arrow** repeatedly until arrow is next to Service.
- 3) Press **Enter** to advance into Service menu.
- 4) Press **Right Arrow** repeatedly until HART® Operation Mode appears.
- 5) Press **Enter** to advance into HART® Operation Mode.
- 6) Press **Right Arrow** to move arrow next to Multi-Drop.
- 7) Press **Enter** to enter Multi-Drop and set the HART® address.
  - a) Use the **Up Arrow** to increase the value of the number highlighted.
  - b) Use the **Right Arrow** to move one segment to the right.
- 8) When the address is set, press **Enter** to save the new address and jump to Current.
  - a) Use the **Up Arrow** to change the current value between 4mA & 8mA.
  - b) When the current is set, press **Enter** to save the new current.

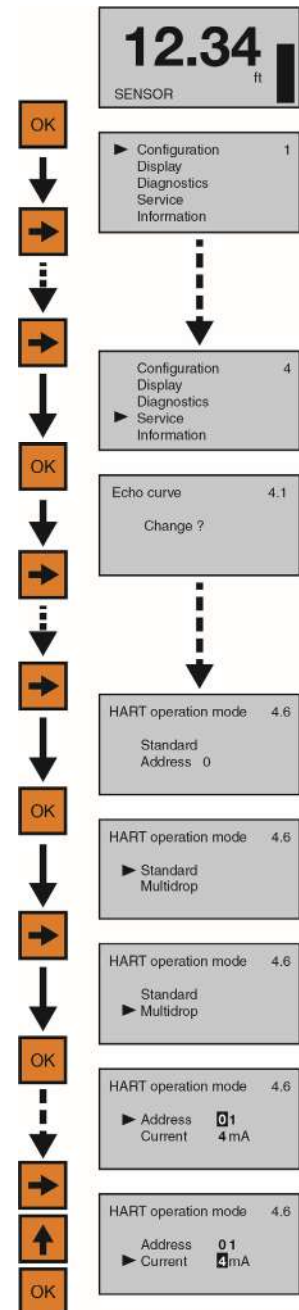

When the setting is correct for your application, press **Enter** again to return to HART® Operational Mode, press the **ESC** button to return to Service Menu and press **ESC** a second time to return to the Main screen.

## CREATE A NEW FALSE ECHO CURVE

Obstructions in the tank (mixer blades, side wall weld joints or material build-up, submersible pumps, piping, other apparatus) or tall tank risers or installation fittings can create false echo returns that impair the sensor's measurement. This function maps all echo returns within the tank, differentiating between good and false echoes, and stores those identified as false into the False Echo Curve, so they will not be considered in the level measurement. **Note:** A False Echo Curve should only be performed when the tank is empty so that all false reflections will be detected. Before starting, measure and note the exact distance from the sensor's measurement location to the media surface. Setting the distance value too large or too short can force the sensor into ignoring the true level.

- 1) From the Main Screen, press **OK** to advance into the Main Menu.
- 2) Press **Right Arrow** repeatedly until the arrow is next to Service.
- 3) Press **OK** to advance into Service Menu and Echo Curve will appear.
- 4) Press **OK** to make a change to the Echo Curve settings.
- 5) Press **Right Arrow** repeatedly until the arrow is next to Create New.
- 6) Press **OK** to advance into Create New. Enter the distance from the sensor's measurement location to the media surface.
- 7) Use the **Right Arrow** to move one segment to the right. The **Right Arrow** will scroll left to right and then back to the first segment.
- 8) When the value is correct, press **OK** to save the setting and begin the False Echo Curve mapping. The process may take a few minutes. When complete, the display will return to the Echo Curve screen.
- 9) When done, press **ESC** to return to the Service Menu and press **ESC** a second time to return to the Main Screen.
- 10) From the Main Screen, press **ESC** and the Echo Curve Screen will appear. Follow the Check Echo Curve procedure described at the end of Section Five to confirm that the sensor is performing correctly.

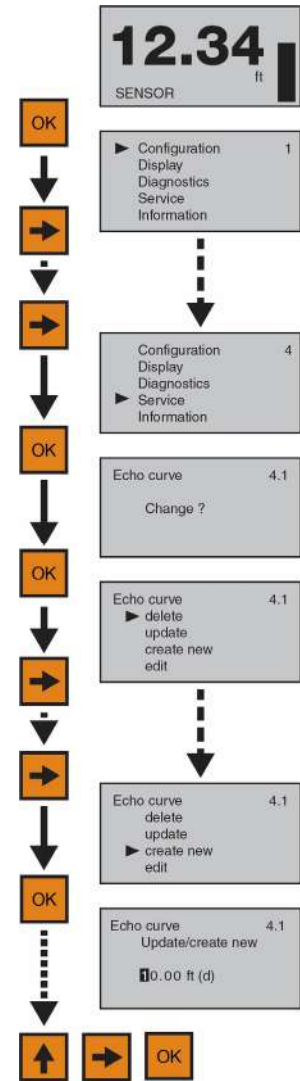

UPDATE AN EXISTING FALSE ECHO CURVE

This function enables an Existing False Echo Curve to be updated under the circumstances that the curve was created when the level was higher than an empty tank condition. **Note:** This function should only be performed to update an Existing False Echo Curve when the level is BELOW the original False Echo Curve. Do not use this function to update an Existing False Echo Curve when the level is above the original False Echo Curve. Before starting, measure and note the exact distance from the sensor's measurement location to the media surface. Setting the distance value too large or too short can force the sensor into ignoring the true level.

Original False Echo Curve

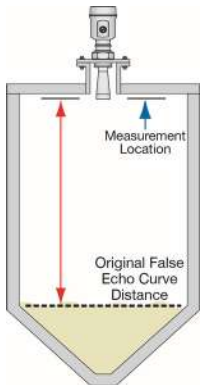

Good Update

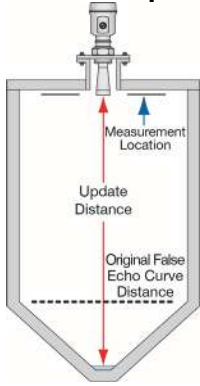

Bad Update

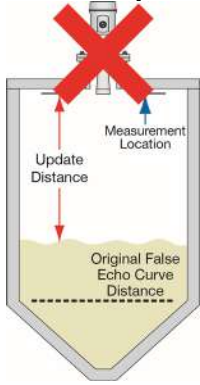

- 1) From the Main Screen, press **OK** to advance into the Main Menu.
- 2) Press **Right Arrow** repeatedly until the arrow is next to Service.
- 3) Press **OK** to advance into Service Menu and Echo Curve will appear.
- 4) Press **OK** to make a change to the Echo Curve settings.
- 5) Press **Right Arrow** repeatedly until the arrow is next to Update.
- 6) Press **OK** to advance into Update. Enter the actual distance from the sensor's measurement location to the media surface.
- 7) Use the **Right Arrow** to move one segment to the right. The **Right Arrow** will scroll left to right and then back to the first segment.
- 8) Use the **Up Arrow** to increase the value of the number highlighted. The **Up Arrow** will scroll from 0 to 9 and back again.
- 9) When the value is correct, press **OK** to save the setting and begin the False Echo Curve mapping. The process may take a few minutes. When complete, the display will return to the Echo Curve screen.
- 10) When done, press **ESC** to return to the Service Menu and press **ESC** a second time to return to the Main Screen.
- 11) From the Main Screen, press **ESC** and the Echo Curve Screen will appear. Follow the Check Echo Curve procedure described at the end of Section Five to confirm that the sensor is performing correctly.

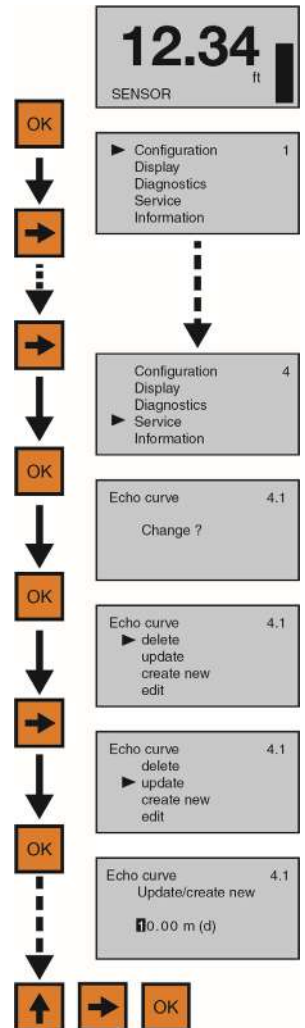

**TROUBLESHOOTING OVERVIEW**

These functions provide troubleshooting information; enable Echo Curve adjustments and deletion of settings.

- 1) Measurement Status
  - a) Displays the signal strength (dB) of the echo returns and the functional status of the sensor including diagnostic error codes.
- 2) Peak Values
  - a) Displays the lowest and highest level height that the sensor has measured in distance (d).
- 3) Simulation
  - a) Simulates the 4-20mA current output from percent of span, current or distance inputs.
- 4) First Echo Adjustment
  - a) Provides the ability to increase or decrease the peak signal strength of the First Echo return.
- 5) Echo Curve Zoom
  - a) Provides the ability to zoom in and magnify the Echo Curve over a specified range.
- 6) False Echo Curve Delete
  - a) Provides the ability to delete a saved False Echo Curve.
- 7) Reset
  - a) Provides the ability to reset configuration settings and memory.

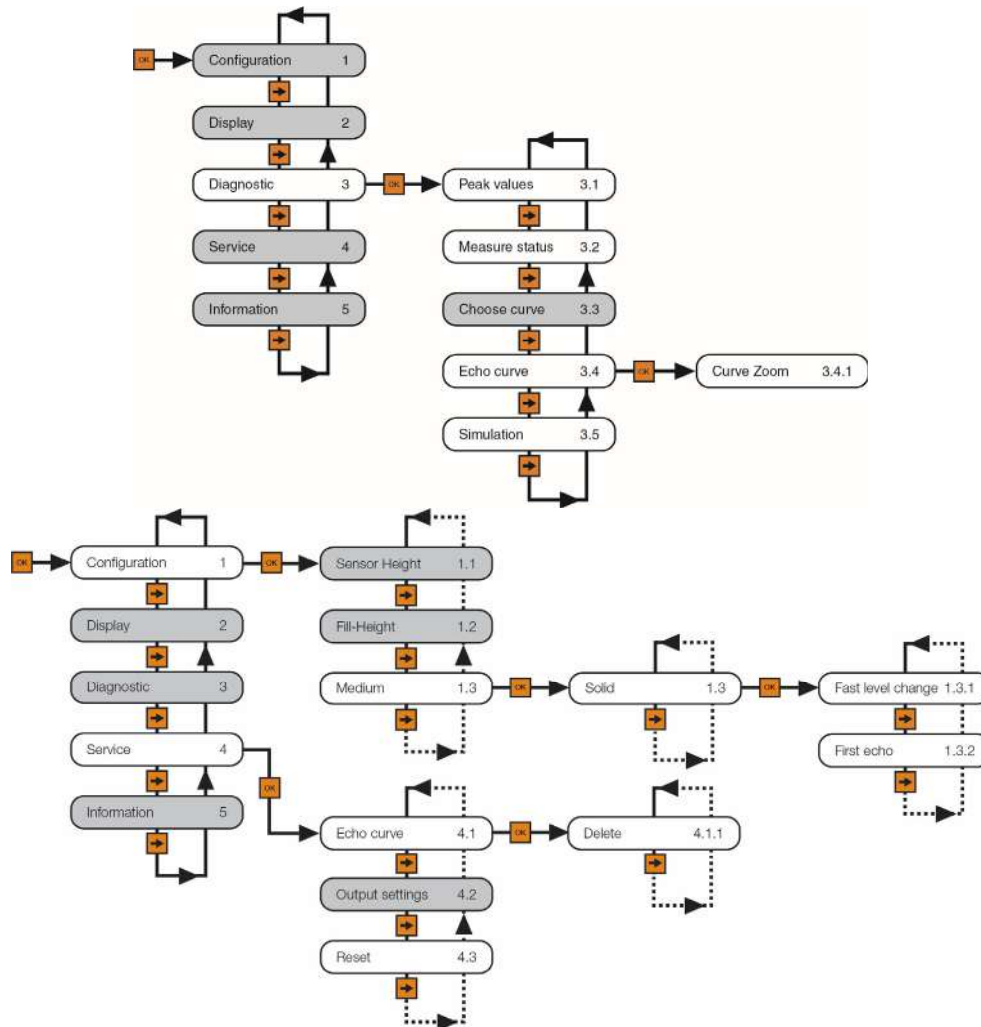

**MEASUREMENT STATUS**

This function displays the signal strength (dB) of the echo returns and the operational status of the sensor including diagnostic error codes.

- 1) From the Main Screen, press **OK** to advance into the Main Menu.
- 2) Press **Right Arrow** repeatedly until the arrow is next to Diagnostics.
- 3) Press **OK** to advance into Diagnostics.
- 4) Press **Right Arrow** to switch to Measurement Status.
- 5) Measurement reliability indicates the decibel (dB) strength of RF energy that's reflecting back to the sensor less any noise. For reliable function, the dB value should be  $\geq 10$  dB.
- 6) Sensor status indicates the functional status of the sensor (either OK or error code)
- 7) When done, press **ESC** to return to the Service Menu and press **ESC** a second time to return to the Main Screen.

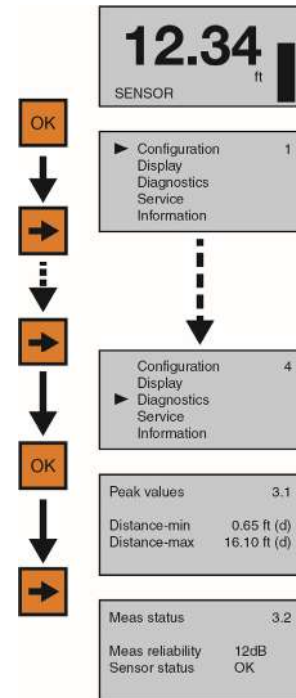

**SENSOR STATUS ERROR CODES**

Error Code	Problem	Solution
E11	Insufficient power	Check power supply
E12	Open circuit	Check wiring for open circuit
E14	Weak echo return (< 10dB)	Check for obstacles under the sensor, either clear the obstacle, move the sensor or perform a False Echo Curve
E15 or E17	ROM error	Contact your distributor

**CURRENT OUTPUT CONDITIONS**

Problem	Solution
Sensor output < 3.9mA	Check wiring for open circuit
Sensor output > 22mA	Check wiring for short circuit
Sensor output reaches 4mA before the tank is empty	Check the Empty Configuration setting, and if incorrect, extend the setting to the empty tank position
Sensor output will not reach 4mA	Check the Range setting, and if incorrect, extend the setting to or slightly below the Empty Configuration setting

**PEAK VALUES**

This function displays the lowest and highest level height that the sensor has measured in distance (d).

- 1) From the Main Screen, press **OK** to advance into the Main Menu.
- 2) Press **Right Arrow** repeatedly until arrow is next to Diagnostics.
- 3) Press **OK** to advance into Diagnostics and view Peak Values.
- 4) Distance-min is the lowest measured level and Distance-max is the highest measured level. Confirm that these values are within the sensor’s operational range.
- 5) If the values appear too high or too low, check the tank for obstructions that could cause that problem.
- 6) When done, press **ESC** to return to the Service Menu and press **ESC** a second time to return to the Main Screen.

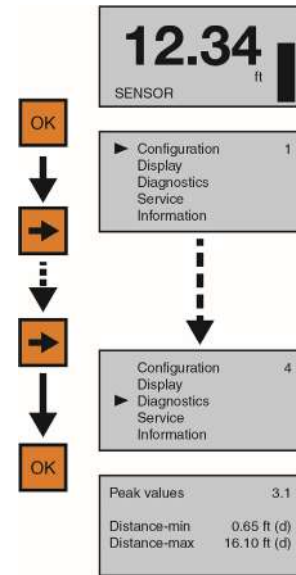

**SIMULATION**

This function simulates the 4-20mA current output, when the sensor is configured and installed on the tank, but the level cannot be changed easily for testing. Percent (of span), Current Output or Distance can be used as the input method to set the current output.

- 1) From the Main Screen, press **OK** to advance into the Main Menu.
- 2) Press **Right Arrow** repeatedly until the arrow is next to Diagnostics.
- 3) Press **OK** to advance into Diagnostics.
- 4) Press **Right Arrow** repeatedly until Simulation appears.
- 5) Press **OK** to advance into Simulation.
- 6) Use the **Right Arrow** to scroll among the three simulation methods (Percent, Current Out or Distance).
- 7) Use **OK** to select the method of simulation.
- 8) Upon selection of a method, the simulation will start and the current output will proportionately reflect the value shown. While the simulation is running, the value can be changed.
- 9) Use the **Right Arrow** to move one segment to the right. The **Right Arrow** will scroll left to right and then back to the first segment.
- 10) Use the **Up Arrow** to increase the value of the number highlighted. The **Up Arrow** will scroll from 0 to 9 and back again.
- 11) When the value is correct, press **OK** and the current output will reflect the value shown.
- 12) When done, press **ESC** to return to Simulation, press **ESC** again to return to the Configuration Menu, and press **ESC** a third time to return to the Main Screen.

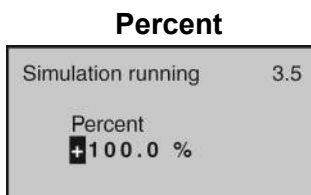
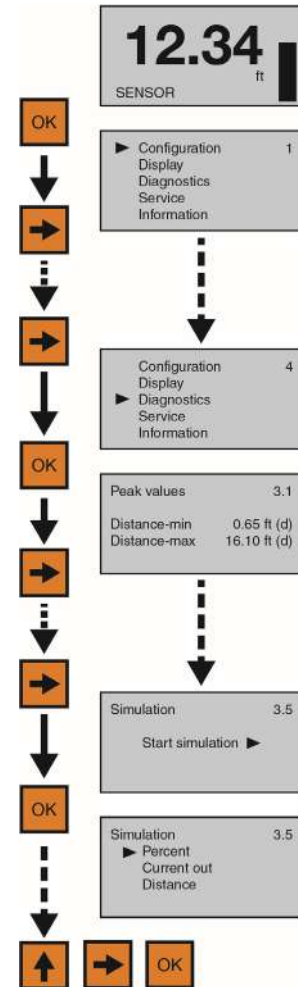

This method uses percentage of span (0-100%) to set the current output (4-20mA) between the Empty and Full Configuration values with 100% equal to 20 mA and 0% equal to 4mA.

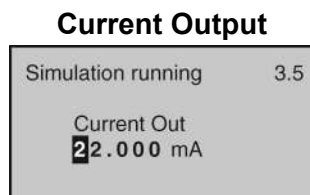

This method directly sets the current output (4-20mA) to the desired value.

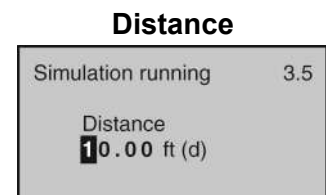

This method uses distance from the sensor's measurement location to set the current output (4-20mA) between the Empty and Full Configuration values.

**FIRST ECHO ADJUSTMENT**

This function increases or decreases the peak strength of the sensor’s First Echo return, and should only be performed if: 1) The media has a very high dielectric constant value and primarily stays in the near full range of the tank, resulting in a very high First Echo peak strength or; 2) Process conditions, such as when the media has a very low dielectric constant value, or when obstructions, heavy foam or turbulence exist in the tank, resulting in little or no First Echo peak strength. **Note:** Under condition one (Example 1), it can be beneficial to decrease the First Echo peak strength. Under condition two (Example 3), it can be beneficial to increase the First Echo peak strength.

**Example 1**

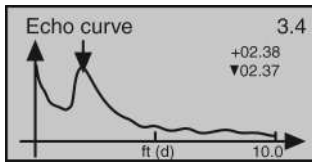

First Echo peak is very strong and can be reduced.

**Example 2**

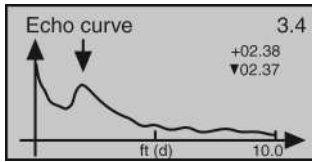

First Echo peak is normal and no adjustment is required.

**Example 3**

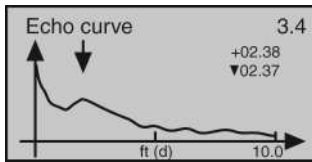

First Echo peak is weak and can be increased.

**First Echo Adjustments**

- Normal - No adjustment
- Small - Decrease by 10 dB
- Big - Increase by 10 db
- Bigger - Increase by 20 db
- Biggest - Increase by 40 db

1. From the Main Screen, press **OK** to advance into the Main Menu.
2. Press **OK** to advance into the Configuration Menu.
3. Press **Right Arrow** to move from Empty Configuration to Full Configuration.
4. Press **Right Arrow** to move from Full Configuration to Medium.
5. Press **OK** to advance into Medium and Liquid, Solid & Low Dielectric will appear.
6. Press **OK** to advance into Media and Fast Level Change will appear.
7. Press **Right Arrow** to move from Fast Level Change to First Echo.
8. Press **OK** to advance into First Echo.
9. Press **Right Arrow** to change the First Echo setting.
10. When setting is correct, press **OK** to save.
11. When done, press **ESC** to return to Medium, press **ESC** again to return to the Configuration Menu, and press **ESC** a third time to return to the Main Screen.

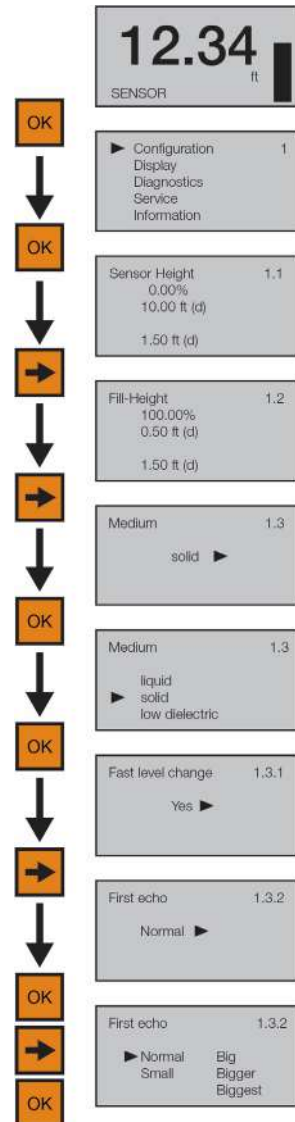

**ECHO CURVE ZOOM**

This function zooms in and magnifies an Echo Curve over a specified range.

- 1) From the Main Screen, press **OK** to advance into the Main Menu.
- 2) Press **Right Arrow** repeatedly until the arrow is next to Diagnostics.
- 3) Press **OK** to advance into Diagnostics.
- 4) Press **Right Arrow** repeatedly until Echo Curve appears.
- 5) Press **OK** to advance into Echo Curve.
- 6) Use the **Right Arrow** to scroll among the three settings (X-zoom, Y-zoom, Unzoom).
- 7) Press **OK** to select X-zoom.
- 8) Press **OK** to advance into the first X-zoom boundary (Example 1). Press **Right Arrow** to move the boundary to its desired location. Press **OK** to set the boundary and a second X-zoom boundary will appear.
- 9) Press **Right Arrow** to move the boundary to its desired location (Example 2). Press **OK** to set the boundary and the screen will show the expanded X-axis (Example 3). Press **ESC** to exit.
- 10) Press **OK** to advance into Y-zoom (Example 4). Press **Right Arrow** to move to the desired zoom magnification (Example 5). Press **OK** to set the zoom and the screen will show the expanded Y-axis (Example 6). **Note:** If you wish to start over, press **ESC**, return to Echo Curve, select Unzoom, and begin the procedure again.
- 11) When done, press **ESC** to return to Echo Curve, press **ESC** again to return to Diagnostics, and **ESC** a third time to return to the Main Screen.

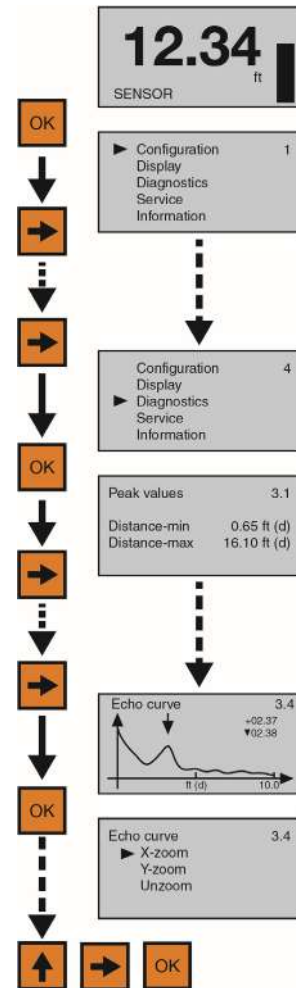

**X-zoom (Example 1)**

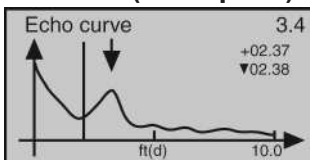

**X-zoom (Example 2)**

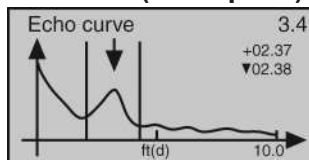

**X-zoom (Example 3)**

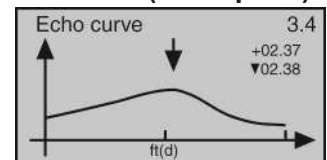

**Y-zoom (Example 4)**

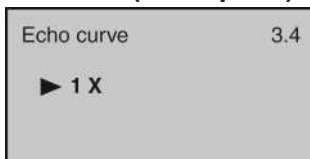

**Y-zoom (Example 5)**

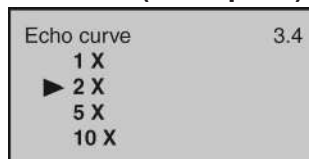

**Y-zoom (Example 6)**

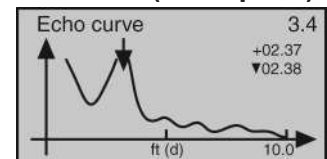

**FALSE ECHO CURVE DELETE**

This function deletes a saved False Echo Curve. **Note:** *If you are dissatisfied with the sensor's performance (operating with a False Echo Curve), you may delete it, and consider creating a new False Echo Curve.*

- 1) From the Main Screen, press **OK** to advance into the Main Menu.
- 2) Press **Right Arrow** repeatedly until the arrow is next to Service.
- 3) Press **OK** to advance into Service and Echo Curve will appear.
- 4) Press **OK** to make a change to Echo Curve.
- 5) Press **OK** to select Delete.
- 6) Press **OK** to Delete All.
- 7) Press **ESC** to return to Service and press **ESC** a second time to return to the Main Screen.

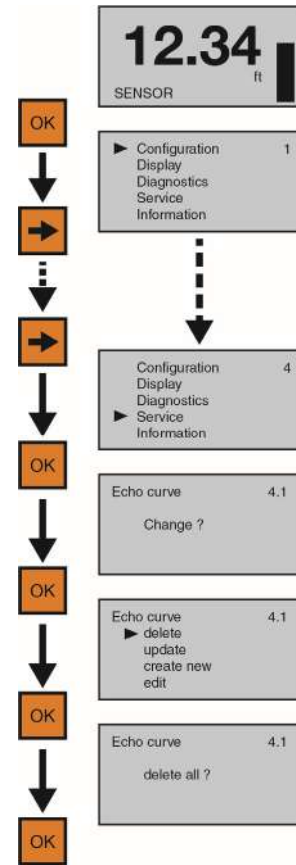

**RESET**

This function resets the sensor's configuration (basic or factory) settings and memory (peak values measured).

- 1) From the Main Screen, press **OK** to advance into the Main Menu.
- 2) Press **Right Arrow** repeatedly until the arrow is next to Service.
- 3) Press **OK** to advance into Service.
- 4) Press **Right Arrow** repeatedly until Reset appears.
- 5) Press **OK** to advance into Reset.
- 6) Use the **Right Arrow** to scroll among the three reset types (Basic Reset, Factory Settings, Peak Value Meas).
  - a) Basic Reset
    - i) Resets basic configuration settings, process adjustment settings, and peak level values in memory (retaining any advanced adjustment settings).
  - b) Factory Settings
    - i) Resets ALL settings and memory to factory default.
  - c) Peak Values Measured
    - i) Resets the minimum and maximum peak level values in memory (retaining any basic configuration, process adjustment and advanced adjustment settings).
- 7) Use **OK** to select the desired type of reset.
- 8) When done, press **ESC** to return to Service, and press **ESC** a second time to the Main Screen.

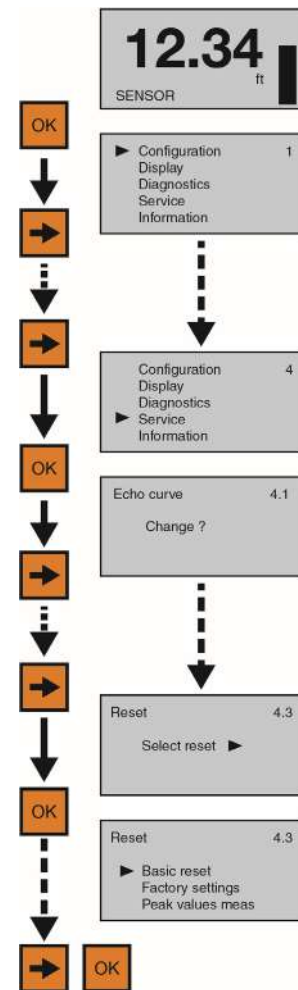

CONFIGURATION MENU

The basic configuration functions are found under Configuration. The below tree shows the 10 function settings and how to navigate between them.

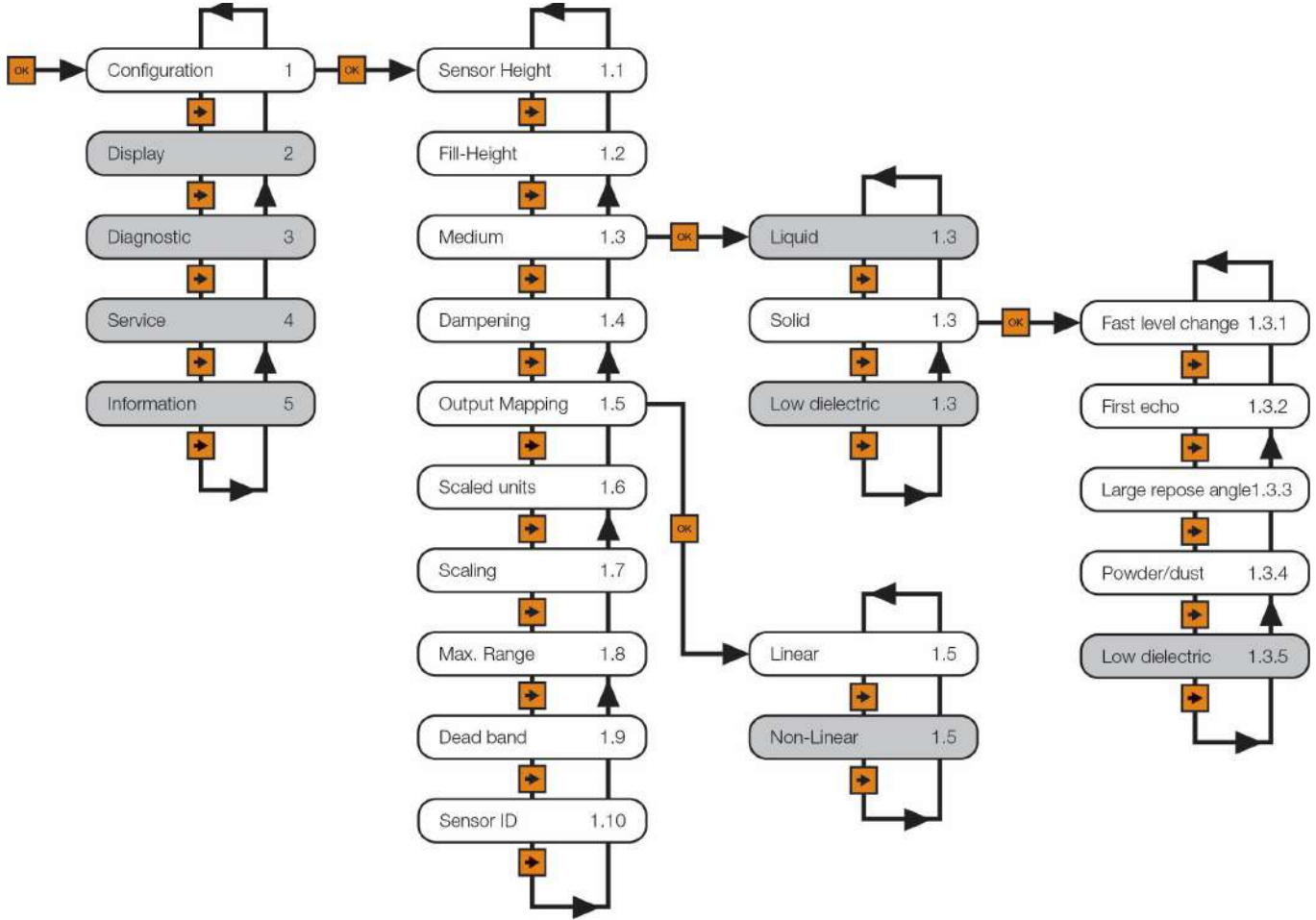

**Note:** Press **ESCAPE** to back-up to the previous level.

**EMPTY CONFIGURATION**

This function adjusts the empty linear scaled current output (4mA) and provides two different adjustment methods:

- The primary method involves setting the value based upon the distance from the bottom of the sensor. This is a measured value using the units of operation for the sensor. For example, if the units of operation are in meters, then the setting must also be in meters.
- A second method involves setting a value based upon the percentage of the **Range** value. For example, if the **Range** is set to 10ft, then a 10% setting is equivalent to 1ft of media height or 9ft of air gap away from the sensor. **Note:** Set the **Range** value before setting the **Empty Configuration** value.

Sensor Height	1.1
0.00%	
25.00 ft (d)	
21.50 ft (d)	

Shows the percentage of empty based upon the **Range** setting.

Shows the distance from the bottom of the sensor to the empty tank.

Shows the air gap distance from the media to the bottom of the sensor.

**FULL CONFIGURATION**

This function adjusts the full linear scaled current output (20mA) and provides two different adjustment methods:

- The primary method involves setting the value based upon the distance from the 0% level setting (see below). This is a measured value using the units of operation for the sensor. For example, if the units of operation are in meters, then the setting must also be in meters.
- The second method involves setting a value based upon the percentage of the **Range** value. For example, if the **Range** is set to 10ft, then a 95% setting is equivalent to 9.5ft of media height or 0.5ft or air gap away from the sensor. **Note:** Set the **Range** value before setting the **Full configuration** value.

Fill-Height	1.2
100.00%	
01.50 ft (d)	
01.75 ft (d)	

Shows the percentage of full based upon the **Range** setting.

Shows the distance from the bottom of the sensor to the full tank.

Shows the air gap distance from the media to the bottom of the sensor.

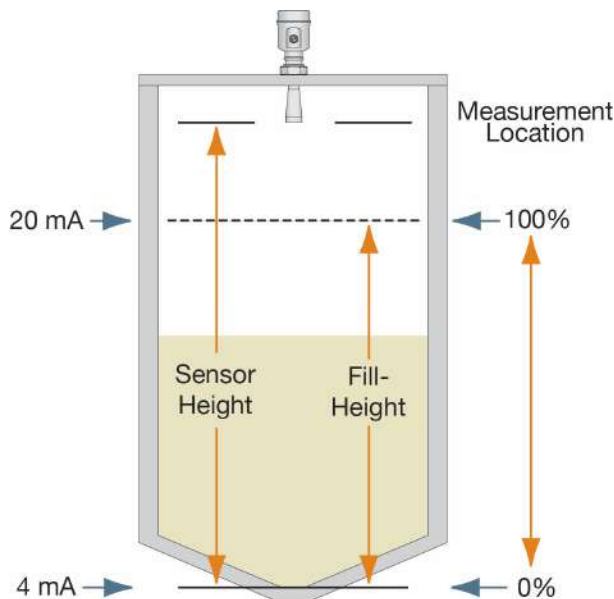

**MEDIUM**

This function identifies the type of media that the sensor is measuring including Liquid, Solid or Low Dielectric. Each has various settings to address the different reflective properties associated with each medium. **Default is Liquid.**

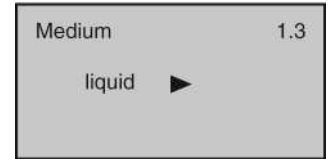

The **Liquid Medium** function has the following settings:

- **Fast Level Change** - Used when the media's level rise or fall within the tank is greater than a rate of 1" per second (25.4mm/sec). Selections are YES or NO. **Default is NO.**

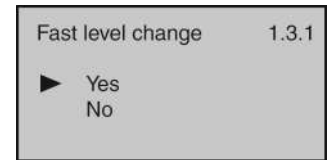
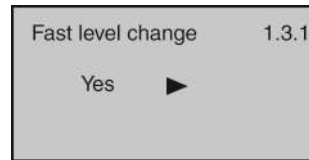

- **First Echo** - Used when the sensor has difficulty seeing the first echo return. This setting adjusts the peak strength (dB) of the first echo. **Default is Normal.** Below are the settings:

- **Normal** - No adjustment
- **Small** - Decreases by 10dB
- **Big** - Increases by 10dB
- **Bigger** - Increases by 20dB
- **Biggest** - Increases by 40dB

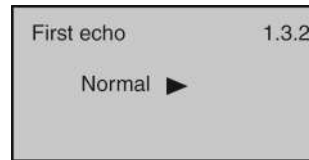

- **Turbulent Surface** - Used when the surface of the liquid is turbulent or agitated. Selections are YES or NO. **Default is NO.**

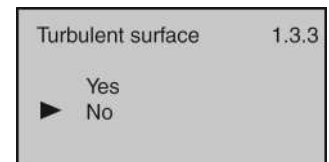
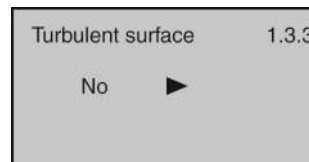

- **Foam** - Used when the entire liquid surface is covered with foam. Selections are YES or NO. **Default is NO.**

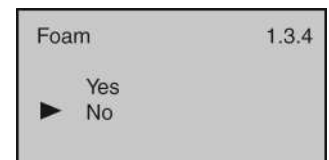

- **Low Dielectric** - Used when the liquid has a low dielectric constant (*and should not be performed without first consulting with the factory*). Selections are YES or NO. **Default is NO.**

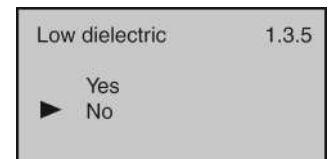
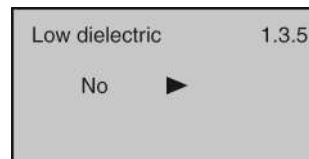

- **Still Well** - Used when the sensor is installed in a still well, stand pipe or sight glass. Selections are YES or NO. **Default is NO.** *Note: If YES is selected, the pipe (inner) diameter must be entered.*

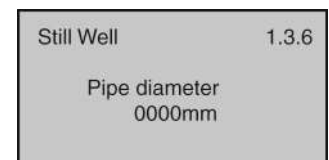
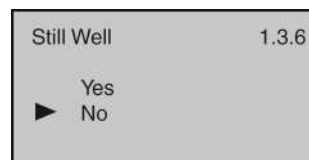
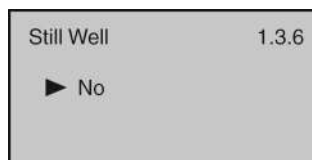

The **Solid Medium** function has the following settings (*and should not be performed without first consulting with the factory*):

- **Fast Level Change** - Used when the media's level rise or fall within the tank is greater than a rate of 1" per second (25.4mm/sec). Selections are YES or NO. **Default is NO.**
  
- **First Echo** - Used when the sensor has difficulty seeing the first echo return. This setting adjusts the peak strength (dB) of the first echo. **Default is Normal.** Below are the settings:
  - **Normal** - No adjustment
  - **Small** -Decreases by 10dB
  - **Big** - Increases by 10dB
  - **Bigger** - Increases by 20dB
  - **Biggest** - Increases by 40dB
  
- **Large Repose Angle** - Used when the repose angle of the material is steep. Repose angle is the steepest angle of ascent or descent relative to the horizontal plane that a material can be piled without sliding. The repose angle varies between different materials. Selections are Yes or No. **Default is No.**
  
- **Powder / Dust** - Used when powder or dust are present in the atmosphere above the material. Selections are Yes or No. **Default is No.**
  
- **Low Dielectric** - Used when the material has a low dielectric constant (*and should not be performed without first consulting with the factory*). Selections are YES or NO. **Default is NO.**

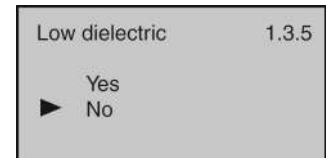
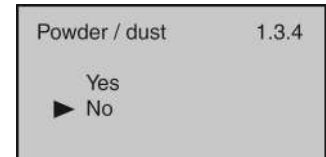
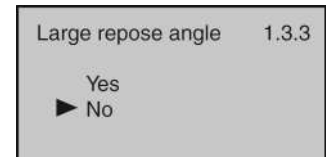
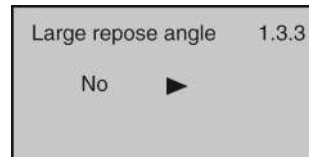
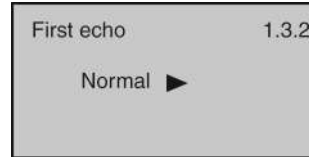
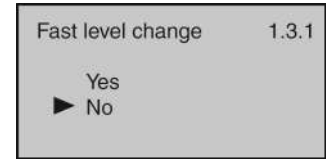
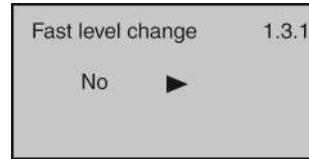

The **Low Dielectric Medium** function has the following settings (*and should not be performed without first consulting with the factory*):

When the dielectric constant of the media is  $\leq 4$ , the amplitude of the direct echo from the media may be low and difficult to detect. However, by measuring the echo reflected from the bottom of the tank, the media level can be measured. Two parameters must be input to complete the setup: 1) Distance from the bottom of the sensor to the tank bottom (Empty Span) and; 2) Distance from the tank bottom to the media level (True Level).

- **Empty Span** - Distance from the bottom of the sensor to the tank bottom.
- **True Level** - Distance from the tank bottom to the media level.
- **DK** - Media dielectric constant (determined by sensor).

Micro DK setup	1.3.1
Empty Span	25.00 ft
True Level	15.25 ft
DK	1.40
	09.75 ft(d)

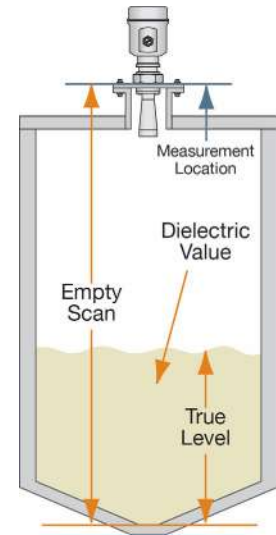

**Note:** Once this feature has been activated, only a factory setting can undo its activation. A factory reset will erase all active settings including Echo Curves.

**DAMPEN**

This function sets the sampling rate for which the sensor updates the current output. The value is entered in seconds. **Default is 6 seconds.**

- Decreasing the value will make the output more responsive to level changes.
- Increasing the value will make the output less responsive to level changes.

Dampening	1.4
	6 sec

**OUTPUT MAPPING**

This function sets the correlation between the measured value and the current output. Selections are Linear or Non-Linear. **Default is Linear.**

- Keep the setting on Linear. **Note:** This setting should not be changed without first consulting with the factory.

Output mapping	1.5
	Linear ▶

**SCALED UNITS**

This function sets the type of measurement (Height, Volume, Mass, Flow or No-Units) and units of measurement (which vary based upon the type of measurement) displayed and input during configuration. **Default is Height in Units of feet (ft).**

Scaled units	1.6
	Height ▶
	ft ▶

Scaled units	1.6
▶ Height	Volume
Mass	No-units
Flow	

Scaled units	1.6
m	cm
▶ ft	mm
in	

Scaled units	1.6
Height	▶ Volume
Mass	No-units
Flow	

Scaled units	1.6
m3	ft3
l	in3
hl	▶ gal

**SCALING**

This function sets the span values for 0% and 100% as an alternative method of adjusting the **Empty Configuration** and **Full Configuration** settings. **Defaults are 0% and 100%.**

Scaling	1.7
0% =	0.50 ft
100% =	15.00 ft

**RANGE**

This function sets the maximum range that the sensor can measure which is typically the distance from the bottom of the sensor to the empty tank bottom. **Default is the maximum range of the sensor.**

Max. Range	1.8
	32.81 ft (d)

**DEAD BAND**

This function sets the dead band or the minimum distance that the sensor will measure. **Default is 12" (30cm).** Minimum setting is 2" from the bottom of the antenna. *Consult factory when setting the dead band less than the factory setting.*

Dead band	1.9
	1.00 ft (d)

**SENSOR ID**

This function sets an 11-digit identification code. The setting can use alphanumeric values from A to Z and 0 to 9. **Default is the sensor's 4-digit Series number.**

Sensor ID	1.10
	Sensor

**DISPLAY MENU**

This menu sets the **Display Value** and **LCD Contrast**. The below tree shows the 2 function settings and how to navigate between them.

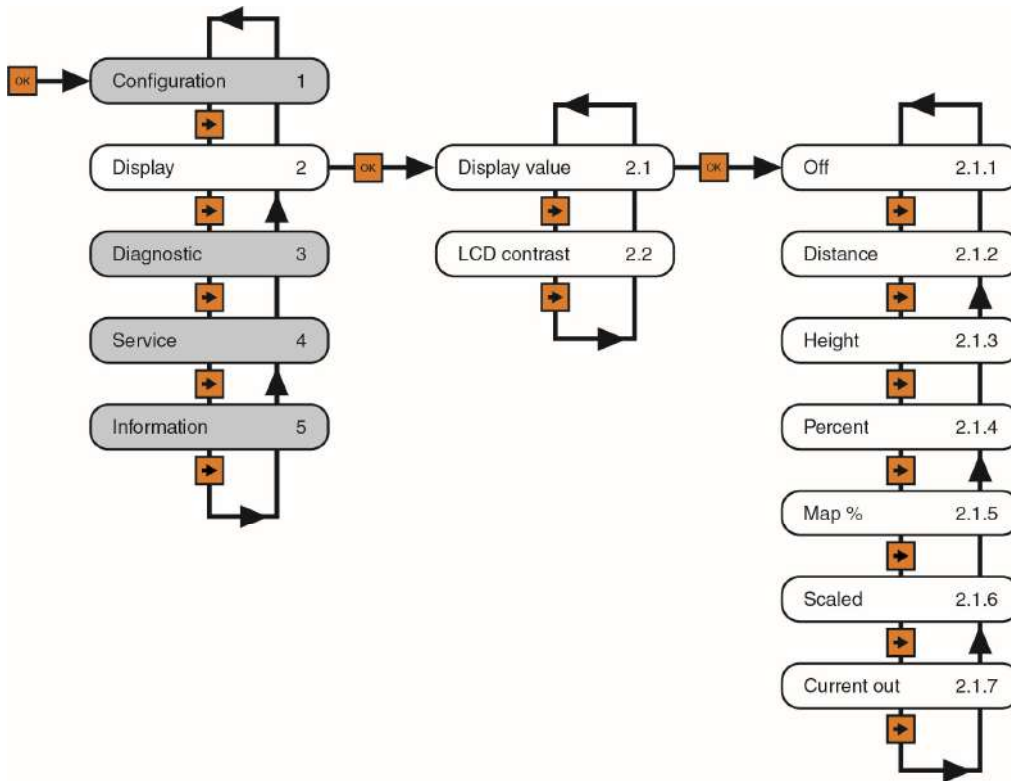

**DISPLAY VALUE**

This function sets the **Display Value**. **Default is (air gap) Distance**. Below are the settings:

- **OFF** - Turns the display OFF.
- **Distance** - Displays the distance from the bottom of the sensor to the media surface.
- **Height** - Displays the height of media in the tank from the **Maximum Range Setting**.
- **Percent Span** - Displays the level based on its percentage of operational span.
- **Map Percentage** - Displays the level based on its percentage of operational range.
- **Scaled** - Displays the level based on a scaled value between 0 (empty) and 10 (full).
- **Current Output** - Displays the 4-20 mA current output.

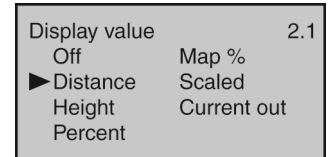
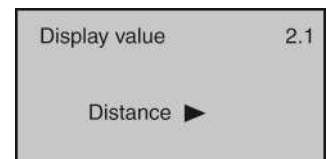

**LCD CONTRAST**

This function sets the B/W display contrast. Press the **Up Arrow** to increase the contrast, and press the **Right Arrow** to decrease the contrast.

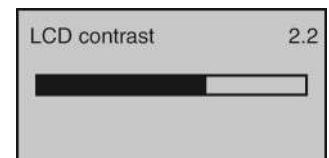
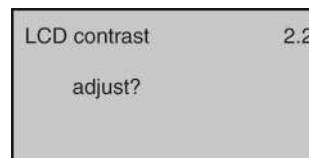

**DIAGNOSTICS MENU**

This menu provides information about the operational status of the sensor and diagnostic tools. The below tree shows the 5 function settings and how to navigate between them.

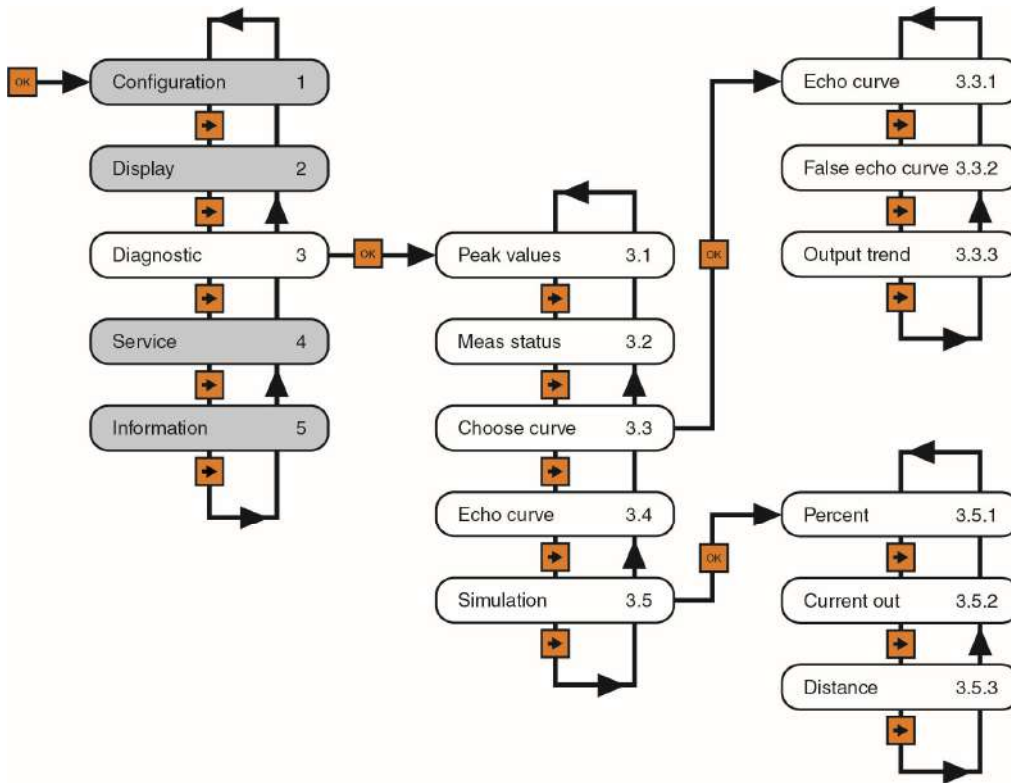

**PEAK VALUES**

This function displays the lowest and highest level height distances (d) that the sensor has measured during operation. To reset these values, use the Reset >> Peak Measured Values option found under the Service Menu.

Peak values	3.1
Distance-min	0.65 ft (d)
Distance-max	16.10 ft (d)

**MEASUREMENT STATUS**

This function displays the signal strength (dB) of the echo returns (Measurement Reliability) and the operational status of the sensor (Sensor Status). A signal strength of 10dB or higher is acceptable. Anything under 10dB is considered a weak signal. The cause of a weak signal is often obstructions within the beam path or a poor installation.

Meas status	3.2
Meas reliability	10dB
Sensor status	OK

Sensor status confirms whether the sensor is operating as expected. If normal, the descriptor will be OK. If abnormal, the descriptor will be one of the following error codes:

- E11** – Insufficient power error
- E12** – Sensor open circuit
- E14** – Weak return echo
- E15** – ROM error
- E17** – ROM error

**CHOOSE CURVE**

This function sets which information is displayed. **Default is Echo Curve.**

- Echo Curve - Shows the echo return energy received by the sensor over distance.
- False Echo Curve - Shows the false echo returns which are mapped out (not considered) by the sensor.
- Output Trend - Shows recent history of where the past level readings have occurred.

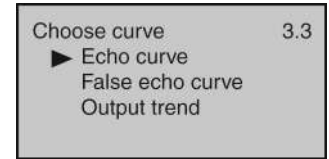
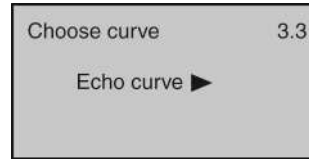

**ECHO CURVE**

This function shows the Echo Curve and allows the user to zoom in and magnify information along the X-axis and Y-axis.

- X-zoom - Expands echo information along the X-axis. Used to determine the location of an echo.
- Y-zoom - Expands echo information along the y-axis. Used to determine the energy of an echo.
- Unzoom - Returns the display to the original setting.

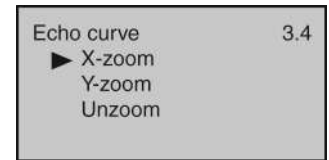
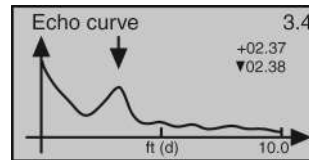

**SIMULATION**

This function sets a fixed 4-20mA current output from the sensor for purposes of testing devices receiving information from the sensor. The simulated current output may be set with the below three input methods:

- Percent - This method uses percentage of span (0-100%) to set the current output (4-20mA) between the Empty and Full Configuration values with 100% equal to 20 mA and 0% equal to 4mA.
- Current Out - This method directly sets the current output (4-20mA) to the desired value.
- Distance - This method uses distance from the sensor's measurement location to set the current output (4-20mA) between the Empty and Full Configuration values.

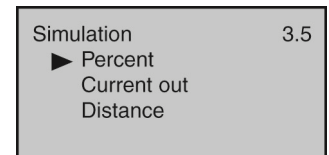
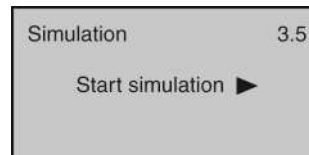

SERVICE MENU

This menu is used to make more advanced adjustments to the sensor. **Note:** Some of these functions should only be performed by a trained technician.

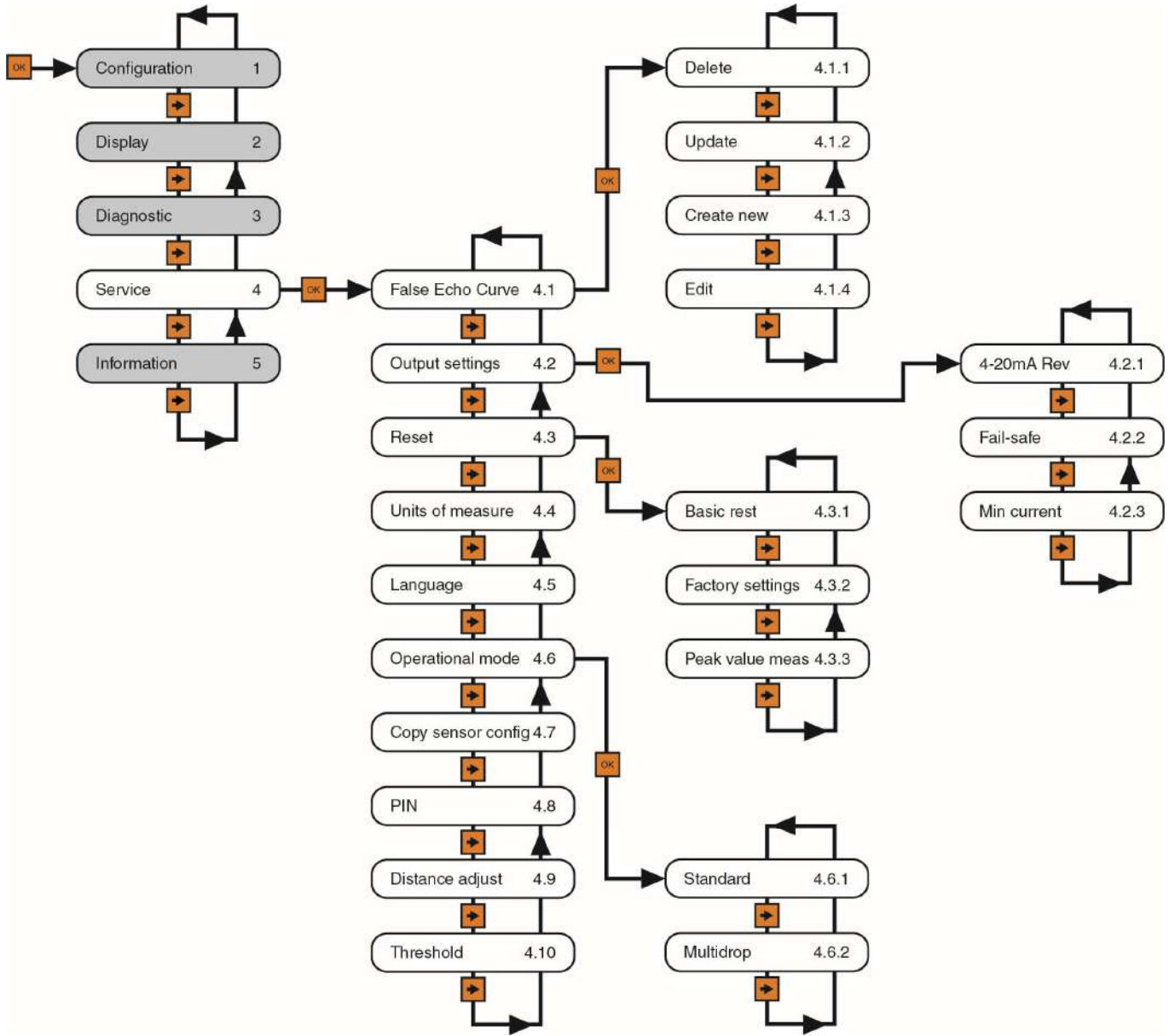

**FALSE ECHO**

Obstructions in the tank (mixer blades, side wall weld joints or material build-up, submersible pumps, piping, other apparatus) or tall tank risers or installation fittings can create false echo returns that impair the sensor’s measurement. This function maps all echo returns within the tank, differentiating between good and false echoes,

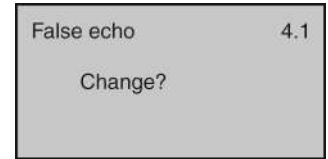

and stores those identified as false into the False Echo Curve, so they will not be considered in the level measurement. **Note:** A False Echo Curve should only be performed when the tank is empty so that all false reflections will be detected.

This function allows the selection of the below False Echo Curve settings:

- Delete - Used to remove a stored False Echo Curve.
- Update - Used to update a stored False Echo Curve.

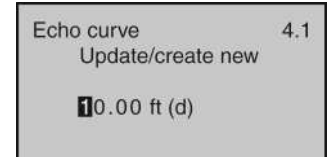

- **Note:** Do not use this function to update an existing False Echo Curve when the level is above the original False Echo Curve.

Create New - Used to create a new False Echo Curve.

- Edit - Used to edit the false echoes stored in a False Echo Curve. **Note:** This function should only be performed by a trained technician.

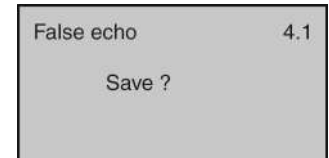
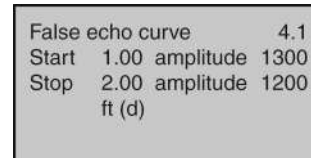

**OUTPUT SETTINGS**

This function allows the selection of the below of 4-20mA Reverse, Fail-Safe and Minimum Current output settings. The initial screen indicates the status of the three functions.

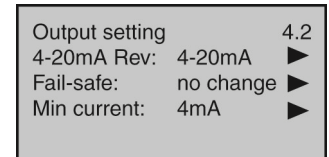

- 4-20 mA Reverse - Used to set the current output at 4-20 mA or 20-4 mA. Selecting 4-20 mA sets the output with 4mA @ bottom and 20mA @ top of the tank. Selecting 20-4 mA sets the output with 20mA @ bottom and 4mA @ top of the tank. **Default is 4-20mA.**

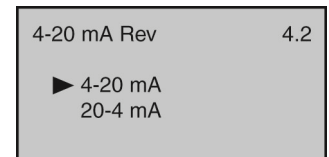
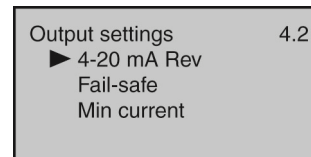

- Fail-Safe – Used to set the current output to a designated if the sensor loses measurement confidence. Selecting No Change will hold the current at its last valid current output. Selecting 20.5mA will force the current to jump to 20.5mA. Selecting 22.5 mA will force the current to jump to 22.5 mA. **Default is 22.0mA.**

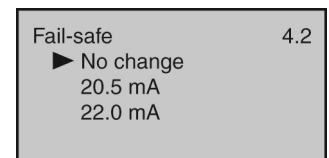
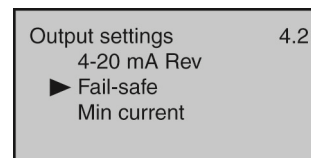

- Minimum Current - Used to set the minimum current output at either 4.0mA or 3.9mA. **Default is 4.0mA.**

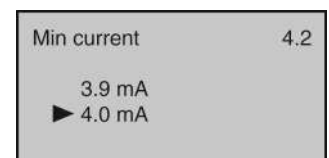
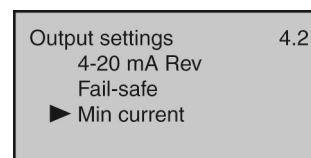

**RESET**

This function allows the configuration (basic or factory) settings and memory (peak values measured) to be reset. Below are the three reset types:

- Basic Reset – Used to reset the basic configuration settings, process adjustment settings, and peak level values in memory (retaining any advanced adjustment settings).
- Factory Settings – Used to reset ALL settings and memory to factory default.

**Note:** Only perform the Factory Setting after consulting with a Flowline Representative. Make sure to record all of your settings including the Distance Adjustment (4.9) setting before performing the Factory Reset.

- Peak Values Measured – Used to reset the minimum and maximum peak level values in memory (retaining any basic configuration, process adjustment and advanced adjustment settings).

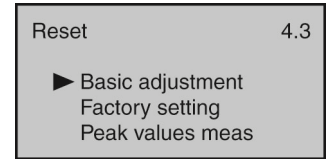

**UNITS OF MEASUREMENT**

This function allows the units of measurement to be changed between Metric and English system units.

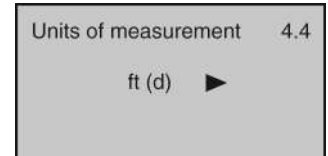

**LANGUAGE**

This function sets the display language. **Default is English.**



**OPERATIONAL MODE**

This function allows for the sensor’s HART® address to be changed from the Standard mode with an address of 0 to a Multidrop mode where the address can be set from 1 to 15. **Default is Address 0.** **Note:** This function should only be performed by a trained technician.

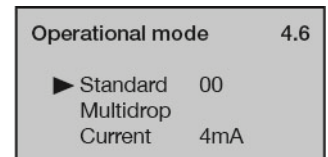
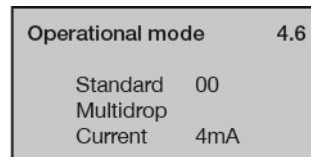

This function allows for the loop consumption (constant current draw) to be set to either 4mA or 8mA. **Default is 4mA.**

**COPY SENSOR DATA**

This function allows configuration and memory data to be uploaded to or downloaded from the sensor. **Note:** This function should only be performed by a trained technician.

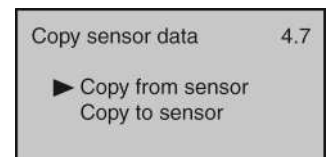
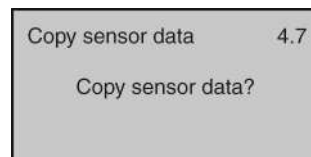

**PIN**

This function allows the sensor configuration to be locked via a preset PIN. **Note:** *This function should only be performed by a trained technician.*

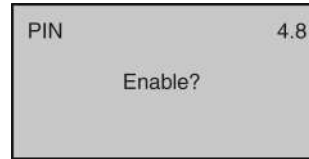

**DISTANCE ADJUSTMENT**

This function allows the factory set distance of a measured value to be adjusted. **Note:** *This function should only be performed by a trained technician. Never change this setting unless instructed by a Flowline representative. Be sure to record this setting if a Factory reset is performed.*

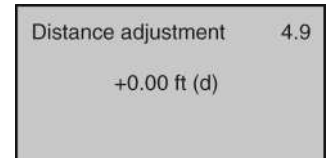

**THRESHOLD**

This function allows the factory set echo threshold to be adjusted. **Note:** *This function should only be performed by a trained technician.*

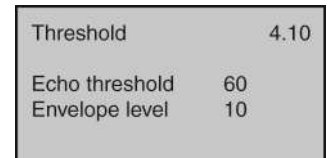

**INFORMATION**

This function displays basic information about your sensor including sensor type, serial number, date of manufacture and software version.

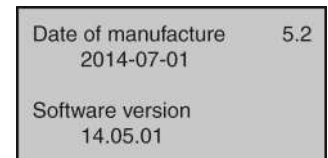
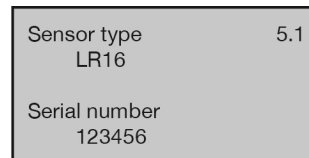

**FACTORY SETTINGS**

Below are the Empty Configuration and Full Configuration factory settings for each sensor.

Series	Sensor Height (4mA)	Fill-Height (20mA)
LR36	49.2' (15m)	47.6' (14.5m)
LR41	229.7' (70m)	228.0' (69.5m)
LR46	229.7' (70m)	228.0' (69.5m)

**USER CONFIGURATION**

Fill out the below chart and keep a record of your sensor configuration.

**Configuration**

Units of Measurement:	Feet	Meters
Empty Configuration:	Full Configuration:	
Range (Maximum):	Dead Band:	

**Process / Advanced Adjustments**

Fast Level Change:	No	Yes	Low Dielectric:	No	Yes
Powder / Dust:	No	Yes	Large Angle:	No	Yes
Dampening Time:	_____				
First Echo:	Normal	Small	Big	Bigger	Biggest

## TROUBLESHOOTING

Subject	Comment
Display Shows E14:	Sensor is in a Fail-Safe state. The return sound pulses are not reaching the transducer. First, cycle power off and on, waiting 5 seconds between the off and on states. If problem persists, check the installation fitting against the Installation instructions in the manual.
Display is opposite of the measured value:	Check the Display Value setting (2.1). Distance mode indicates the distance from the liquid to the sensor. Height mode indicates the height of liquid in the tank. Change the Display Value from Distance to Height or vice versa to correct. This setting does not affect the 4-20mA output.
Transmitter indicates a current of 0 mA:	Check the wiring for an open circuit. An open circuit is the most common issue with a 0 mA signal.
Transmitter jumps to a current reading between 19 and 20 mA:	Check the installation of the transmitter. Bad installation fittings will cause false signals near the top of the tank, which typically translates to a signal between 19 and 20 mA. Also look for interference just below the transmitter. If the transmitter is installed in a metal fitting, switch to a plastic fitting.
Transmitter indicates a current over 23 mA:	Immediately check the wiring for a short circuit. The EchoPulse® is current limited to 22 mA. Anything above 23 mA indicates a short circuit.

### WARRANTY

Flowline warrants to the original purchaser of its products that such products will be free from defects in material and workmanship under normal use and service in accordance with instructions furnished by Flowline for a period of two years from the date of manufacture of such products. Flowline's obligation under this warranty is solely and exclusively limited to the repair or replacement, at Flowline's option, of the products or components, which Flowline's examination determines to its satisfaction to be defective in material or workmanship within the warranty period. Flowline must be notified pursuant to the instructions below of any claim under this warranty within thirty (30) days of any claimed lack of conformity of the product. Any product repaired under this warranty will be warranted only for the remainder of the original warranty period. Any product provided as a replacement under this warranty will be warranted for the full two years from the date of manufacture.

### RETURNS

Products cannot be returned to Flowline without Flowline's prior authorization. To return a product that is thought to be defective, go to [www.flowline.com](http://www.flowline.com), and submit a customer return (MRA) request form and follow the instructions therein. All warranty and non-warranty product returns to Flowline must be shipped prepaid and insured. Flowline will not be responsible for any products lost or damaged in shipment.

### LIMITATIONS

This warranty does not apply to products which: 1) are beyond the warranty period or are products for which the original purchaser does not follow the warranty procedures outlined above; 2) have been subjected to electrical, mechanical or chemical damage due to improper, accidental or negligent use; 3) have been modified or altered; 4) anyone other than service personnel authorized by Flowline have attempted to repair; 5) have been involved in accidents or natural disasters; or 6) are damaged during return shipment to Flowline. Flowline reserves the right to unilaterally waive this warranty and dispose of any product returned to Flowline where: 1) there is evidence of a potentially hazardous material present with the product; or 2) the product has remained unclaimed at Flowline for more than 30 days after Flowline has dutifully requested disposition. This warranty contains the sole express warranty made by Flowline in connection with its products. ALL IMPLIED WARRANTIES, INCLUDING WITHOUT LIMITATION, THE WARRANTIES OF MERCHANTABILITY AND FITNESS FOR A PARTICULAR PURPOSE, ARE EXPRESSLY DISCLAIMED. The remedies of repair or replacement as stated above are the exclusive remedies for the breach of this warranty. IN NO EVENT SHALL FLOWLINE BE LIABLE FOR ANY INCIDENTAL OR CONSEQUENTIAL DAMAGES OF ANY KIND INCLUDING PERSONAL OR REAL PROPERTY OR FOR INJURY TO ANY PERSON. THIS WARRANTY CONSTITUTES THE FINAL, COMPLETE AND EXCLUSIVE STATEMENT OF WARRANTY TERMS AND NO PERSON IS AUTHORIZED TO MAKE ANY OTHER WARRANTIES OR REPRESENTATIONS ON BEHALF OF FLOWLINE. This warranty will be interpreted pursuant to the laws of the State of California. If any portion of this warranty is held to be invalid or unenforceable for any reason, such finding will not invalidate any other provision of this warranty.

For complete product documentation, video training, and technical support, go to [www.flowline.com](http://www.flowline.com).

For phone support, call 562-598-3015 from 8am to 5pm PST, Mon - Fri.

(Please make sure you have the Part and Serial number available.)